

НЕРЖАВЕЮЩАЯ СТАЛЬ

- Соединительная арматура • Фитинги • Регулирующая арматура •
- Специальная арматура и комплектующие • Аксессуары •

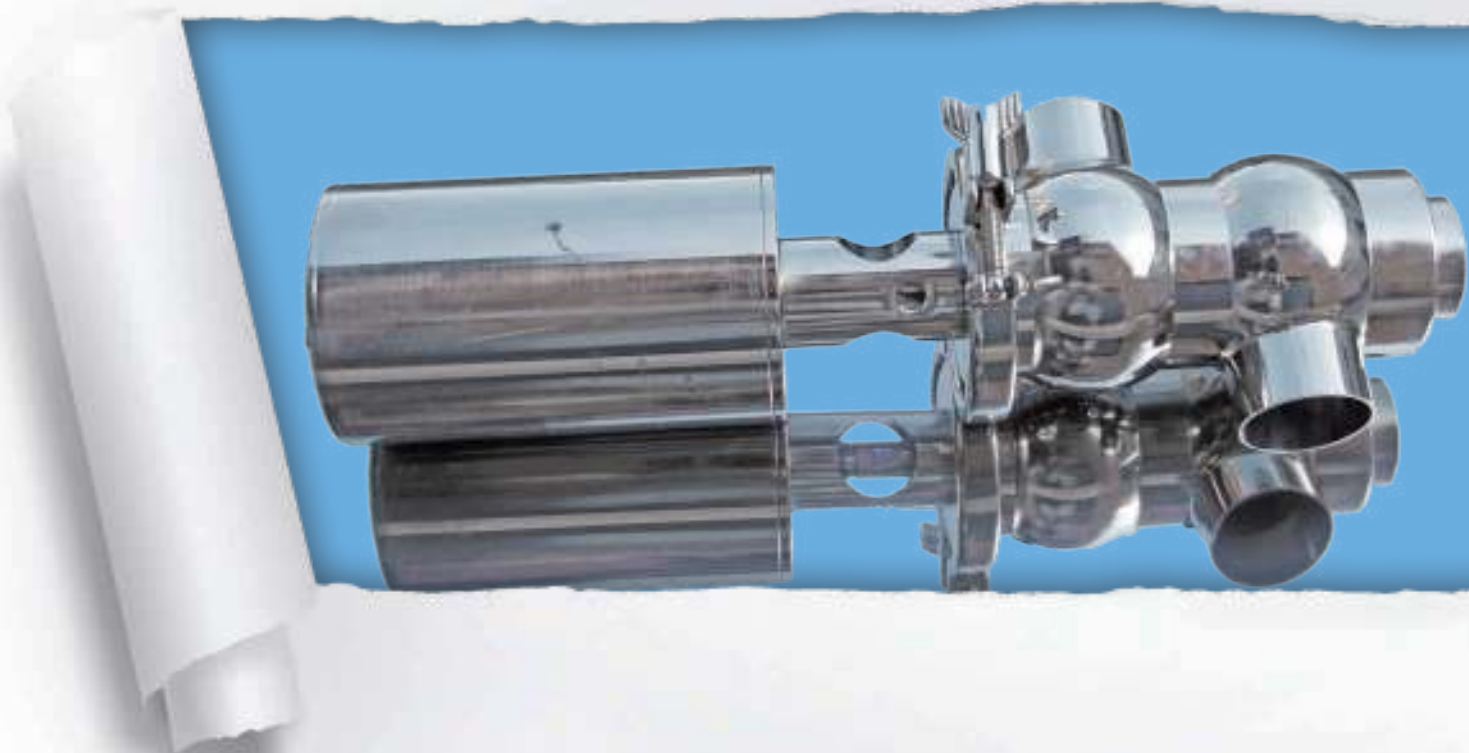



1

Соединительн я рм тур

Муфты
Фл нцы
Кл мпы

РЕЗЬБОВОЕ СОЕДИНЕНИЕ ПОД РАЗВАЛЬЦОВКУ	20090	ОПИСАНИЕ
	DIN 11 851	
		Пищевое резьбовое соединение под развальцовку, к т. № 20090, DIN 11 851 – Простой монтаж – Легкая замена уплотнения
		Размеры: DN 10 – DN 150 Резьба: DIN 405 Материал: 1.4301 (AISI 304) 1.4404 (AISI 316L) Уплотнение: NBR (стандартное) EPDM Viton Silikon PTFE

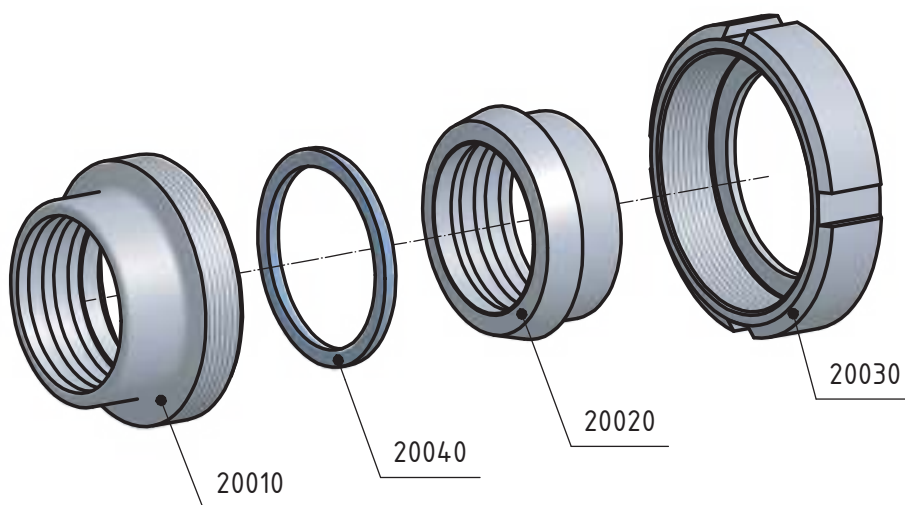
КОМПЛЕКТУЮЩИЕ

Деталь уплотнения

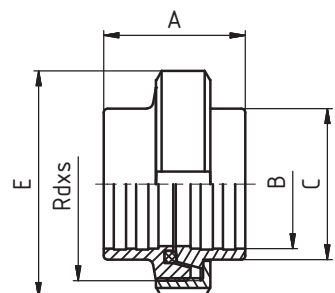
РЕЗЬБОВОЕ СОЕДИНЕНИЕ ПОД РАЗВАЛЬЦОВКУ - КОМПЛЕКТ	20090	РАЗМЕРЫ										
	DIN 11 851	DN	A	B	C	D	E	F	R	L	резьба DIN 405 Rd x s	кг
	25	45	28,2	35		63					52x1/6"	0,16
	32	51	34,2	41		70					58x1/6"	0,19
	40	53	40,3	48		78					65x1/6"	0,24
	50	57	52,3	61		92					78x1/6"	0,34
	65	65	70,4	79		112					95x1/6"	0,51
	80	75	85,4	93		127					110x1/4"	0,72

ГАЙКА НАКИДНАЯ	20030	РАЗМЕРЫ										
	DIN 11 851	DN	A	B	C	D	E	F	R	L	резьб DIN 405 Rd x s	кг
		10	18	19	38					15	28x1/8"	0,07
		15	18	25	44					15	34x1/8"	0,08
		20	20	31	54					17	44x1/6"	0,14
		25	21	36	63					18	52x1/6"	0,18
		32	21	42	70					18	58x1/6"	0,22
		40	21	49	78					18	65x1/6"	0,25
		50	22	62	92					19	78x1/6"	0,33
		65	25	80	112					21	95x1/6"	0,55
		80	29	94	127					25	110x1/4"	0,80
		100	31	115	148					26	130x1/4"	1,08
		125	35	138	178					30	160x1/4"	1,45
		150	40	164	210					34	190x1/4"	1,88

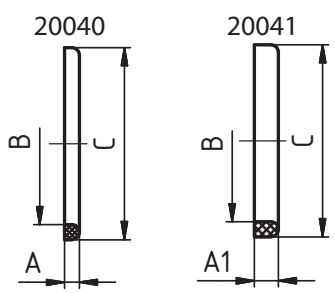
УПЛОТНЕНИЕ	20040	20041	РАЗМЕРЫ											
	DIN 11 851		DN	A	A1	B	C	E	F	R	L	резьб DIN 405 Rd x s	кг	
			10	4	-	12	20						0,0012	
			15	4	-	18	26							0,0016
			20	4	-	23	33							0,0026
			25	5	8	30	40							0,0036
			32	5	8	36	46							0,0040
			40	5	8	42	52							0,0048
			50	5	8	54	64							0,0062
			65	5	8	71	81							0,0070
			80	5	8	85	95							0,0080
			100	6	8	104	114							0,0134
			125	7	8	130	142							0,0236
			150	7	8	155	167							0,0276

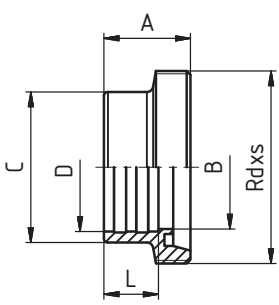
РЕЗЬБОВОЙ ШТУЦЕР ПОД РАЗВАЛЬЦОВКУ	20010	РАЗМЕРЫ										
	DIN 11 851	DN	A	B	C	D	E	F	R	L	резьб DIN 405 Rd x s	кг
		25	29	26	35	28,2				15	52x1/6"	0,16
		32	32	32	41	34,2				18	58x1/6"	0,19
		40	33	38	48	40,3				20	65x1/6"	0,24
		50	35	50	61	52,3				22	78x1/6"	0,34
		65	40	66	79	70,4				25	95x1/6"	0,51
		80	45	81	93	85,4				28	110x1/4"	0,72

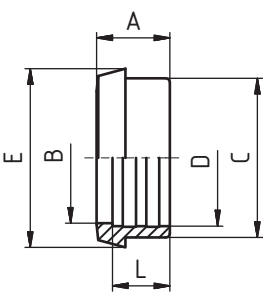
КОНИЧЕСКИЙ ШТУЦЕР ПОД РАЗВАЛЬЦОВКУ	20020	РАЗМЕРЫ										
	DIN 11 851	DN	A	B	C	D	E	F	R	L	резьб DIN 405 Rd x s	кг
		25	22	26	35	28,2	44			15		0,09
		32	25	32	41	34,2	50			18		0,12
		40	26	38	48	40,3	56			20		0,15
		50	28	50	61	52,3	68,5			22		0,22
		65	32	66	79	70,4	86			25		0,32
		80	37	81	93	85,4	100			28		0,40

РЕЗЬБОВОЕ СОЕДИНЕНИЕ	20120	ОПИСАНИЕ
	DIN 11 851	
		Пищевое резьбовое соединение приварное к т. № 20120, DIN 11 851 – Простой монтаж – Легкая замена уплотнения
		Размеры: DN 10 – DN 150 Резьба: DIN 405 Материал: 1.4301 (AISI 304) 1.4404 (AISI 316L) Уплотнение: NBR (стандартное) EPDM Viton Silikon PTFE

КОМПЛЕКТУЮЩИЕ

ТОЛЩИНА СТЕНКИ	
DN 10	1,5 мм
DN 15 - 50	2,5 мм
DN 65 - 100	3,0 мм
DN 125 - 150	3,5 мм

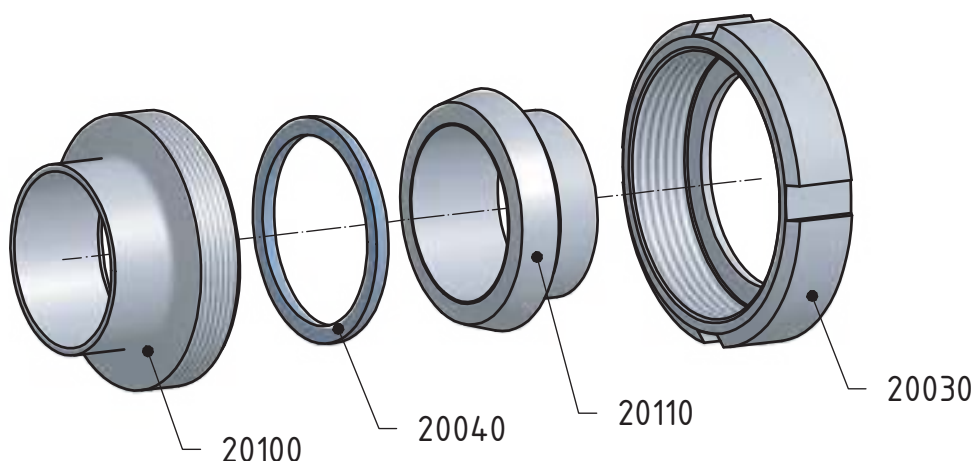
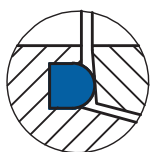

Деталь уплотнения

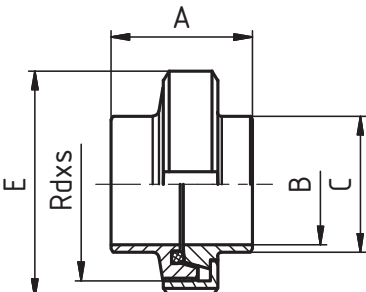
РЕЗЬБОВОЕ СОЕДИНЕНИЕ ПРИВАРНОЕ - КОМПЛЕКТ	20120	РАЗМЕРЫ										
	DIN 11 851	DN	A	B	C	D	E	F	R	L	резьба DIN 405 Rd x s	кг
	10	35	10	15		38					28x1/8"	0,17
	15	35	16	21		44					34x1/8"	0,18
	20	37	20	25		54					44x1/6"	0,32
	25	45	26	31		63					52x1/6"	0,40
	32	51	32	37		70					58x1/6"	0,49
	40	53	38	43		78					65x1/6"	0,58
	50	57	50	55		92					78x1/6"	0,84
	65	65	66	72		112					95x1/6"	1,15
	80	75	81	87		127					110x1/4"	1,74
	100	89	100	106		148					130x1/4"	2,46
	125	69	125	132		178					160x1/4"	3,52
150	74	150	157		210					190x1/4"	4,74	

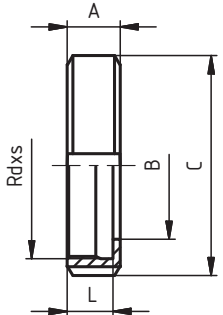
ГАЙКА НАКИДНАЯ	20030	РАЗМЕРЫ										
	DIN 11 851	DN	A	B	C	D	E	F	R	L	резьб DIN 405 Rd x s	кг
		10	18	19	38					15	28x1/8"	0,07
		15	18	25	44					15	34x1/8"	0,08
		20	20	31	54					17	44x1/6"	0,14
		25	21	36	63					18	52x1/6"	0,18
		32	21	42	70					18	58x1/6"	0,22
		40	21	49	78					18	65x1/6"	0,25
		50	22	62	92					19	78x1/6"	0,33
		65	25	80	112					21	95x1/6"	0,55
		80	29	94	127					25	110x1/4"	0,80
		100	31	115	148					26	130x1/4"	1,08
		125	35	138	178					30	160x1/4"	1,45
		150	40	164	210					34	190x1/4"	1,88

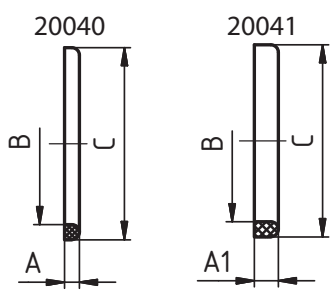
УПЛОТНЕНИЕ	20040	20041	РАЗМЕРЫ											
	DIN 11 851		DN	A	A1	B	C	E	F	R	L	резьб DIN 405 Rd x s	кг	
			10	4	-	12	20						0,0012	
			15	4	-	18	26							0,0016
			20	4	-	23	33							0,0026
			25	5	8	30	40							0,0036
			32	5	8	36	46							0,0012
			40	5	8	42	52							0,0048
			50	5	8	54	64							0,0062
			65	5	8	71	81							0,0070
			80	5	8	85	95							0,0080
			100	6	8	104	114							0,0134
			125	7	8	130	142							0,0236
			150	7	8	155	167							0,0276

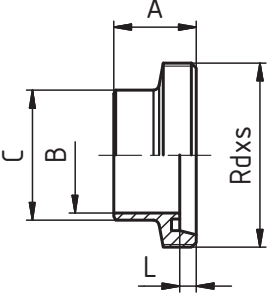
РЕЗЬБОВОЙ ШТУЦЕР ПРИВАРНОЙ	20100	РАЗМЕРЫ										
	DIN 11 851	DN	A	B	C	D	E	F	R	L	резьб DIN 405 Rd x s	кг
		10	21	10	15					4	28x1/8"	0,044
		15	21	16	21					4	34x1/8"	0,046
		20	24	20	25					6	44x1/6"	0,084
		25	29	26	31					7	52x1/6"	0,104
		32	32	32	37					7	58x1/6"	0,112
		40	33	38	43					7	65x1/6"	0,164
		50	35	50	55					7	78x1/6"	0,296
		65	40	66	72					8	95x1/6"	0,280
		80	45	81	87					8	110x1/4"	0,540
		100	54	100	106					10	130x1/4"	0,780
		125	46	125	132					12	160x1/4"	1,140
		150	50	150	157					13	190x1/4"	1,800

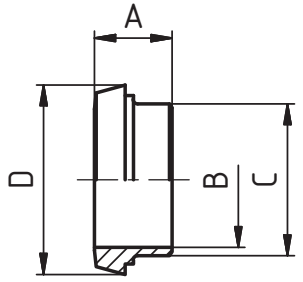
КОНИЧЕСКИЙ ШТУЦЕР ПРИВАРНОЙ	20110	РАЗМЕРЫ											
	DIN 11 851	DN	A	B	C	D	E	F	R	L	резьб DIN 405 Rd x s	кг	
		10	17	10	15	22,5						0,060	
		15	17	16	21	28,5							0,062
		20	18	20	25	36,5							0,100
		25	22	26	31	44							0,120
		32	25	32	37	50							0,160
		40	26	38	43	56							0,165
		50	28	50	55	68,5							0,220
		65	32	66	72	86							0,320
		80	37	81	87	100							0,400
		100	44	100	106	121							0,600
		125	34	125	132	150							0,930
		150	37	150	157	176							1,060

РЕЗЬБОВОЕ СОЕДИНЕНИЕ ТИП «Р»	20120 R	ОПИСАНИЕ
	DIN 11 851	
		<p>Пищевое резьбовое соединение приварное к т. № 20120-R, DIN 11 851</p> <ul style="list-style-type: none"> – Простой монтаж – Легкая замена уплотнения <p>Размеры: DN 10 – DN 150</p> <p>Резьба: DIN 405</p> <p>Материал: 1.4301 (AISI 304) 1.4404 (AISI 316L)</p> <p>Уплотнение: NBR (стандартное) EPDM Viton Silikon PTFE</p>

КОМПЛЕКТУЮЩИЕ

ТОЛЩИНА СТЕНКИ	
DN 10 - 50	1,5 мм
DN 50 - 150	2,0 мм

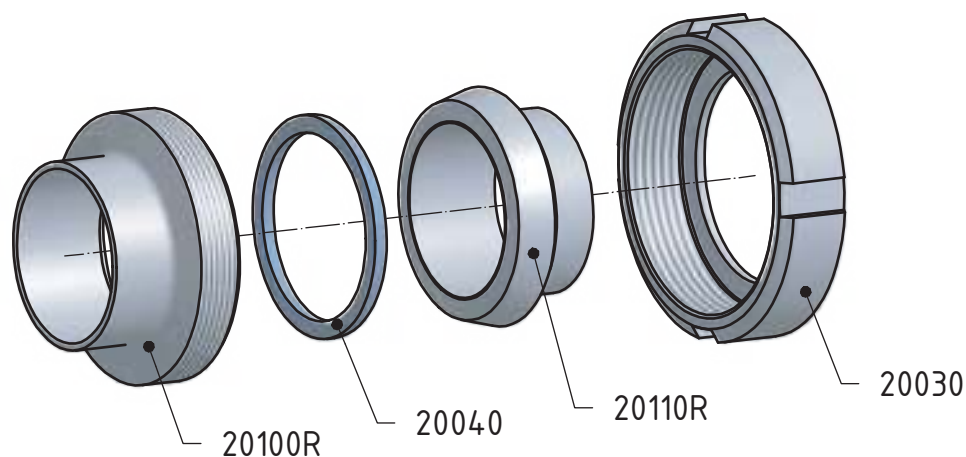
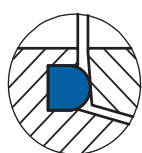

Деталь уплотнения

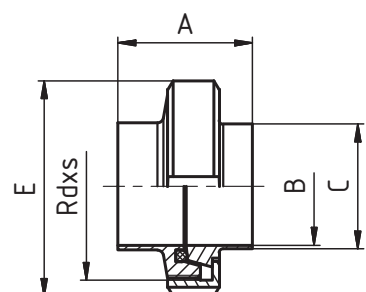
РЕЗЬБОВОЕ СОЕДИНЕНИЕ ПРИВАРНОЕ - КОМПЛЕКТ	20120 R	РАЗМЕРЫ										
	DIN 11 851	DN	A	B	C	D	E	F	R	L	резьба DIN 405 Rd x s	кг
	10	35	10	13		38					28x1/8"	0,13
	15	35	16	19		44					34x1/4"	0,16
	20	37	20	23		54					44x1/6"	0,28
	25	45	26	29		63					52x1/6"	0,37
	32	51	32	35		70					58x1/6"	0,45
	40	53	38	41		78					65x1/6"	0,53
	50	57	50	53		92					78x1/6"	0,67
	65	65	66	70		112					95x1/6"	1,19
	80	75	81	85		127					110x1/4"	1,67
	100	89	100	104		148					130x1/4"	2,32
	125	69	125	129		178					160x1/4"	3,21
	150	74	150	154		210					190x1/4"	4,60

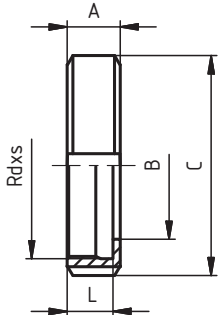
ГАЙКА НАКИДНАЯ	20030	РАЗМЕРЫ										
	DIN 11 851	DN	A	B	C	D	E	F	R	L	резьб DIN 405 Rd x s	кг
		10	18	19	38					15	28x1/8"	0,07
		15	18	25	44					15	34x1/8"	0,08
		20	20	31	54					17	44x1/6"	0,14
		25	21	36	63					18	52x1/6"	0,18
		32	21	42	70					18	58x1/6"	0,22
		40	21	49	78					18	65x1/6"	0,25
		50	22	62	92					19	78x1/6"	0,33
		65	25	80	112					21	95x1/6"	0,55
		80	29	94	127					25	110x1/4"	0,80
		100	31	115	148					26	130x1/4"	1,08
		125	35	138	178					30	160x1/4"	1,45
		150	40	164	210					34	190x1/4"	1,88

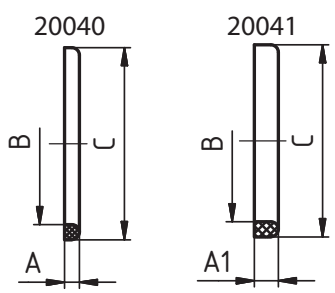
УПЛОТНЕНИЕ	20040	20041	РАЗМЕРЫ										
	DIN 11 851		DN	A	A1	B	C	E	F	R	L	резьб DIN 405 Rd x s	кг
			10	4	-	12	20						0,0012
			15	4	-	18	26						0,0016
			20	4	-	23	33						0,0026
			25	5	8	30	40						0,0036
			32	5	8	36	46						0,0012
			40	5	8	42	52						0,0048
			50	5	8	54	64						0,0062
			65	5	8	71	81						0,0070
			80	5	8	85	95						0,0080
			100	6	8	104	114						0,0134
			125	7	8	130	142						0,0236
			150	7	8	155	167						0,0276

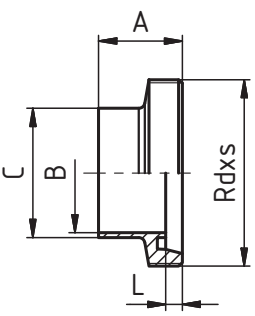
РЕЗЬБОВОЙ ШТУЦЕР ПРИВАРНОЙ	20100 R	РАЗМЕРЫ										
	DIN 11 851	DN	A	B	C	D	E	F	R	L	резьб DIN 405 Rd x s	кг
		10	21	10	13					4	28x1/8"	0,04
		15	21	16	19					4	34x1/8"	0,05
		20	24	20	23					6	44x1/6"	0,09
		25	29	26	29					7	52x1/6"	0,11
		32	32	32	35					7	58x1/6"	0,13
		40	33	38	41					7	65x1/6"	0,16
		50	35	50	53					7	78x1/6"	0,22
		65	40	66	70					8	95x1/6"	0,35
		80	45	81	85					8	110x1/4"	0,52
		100	54	100	104					10	130x1/4"	0,67
		125	46	125	129					12	160x1/4"	0,99
		150	50	150	154					13	190x1/4"	1,71

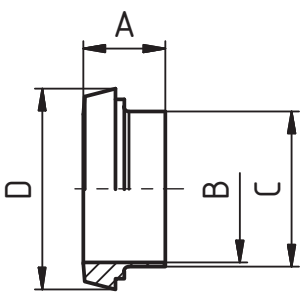
КОНИЧЕСКИЙ ШТУЦЕР ПРИВАРНОЙ	20110 R	РАЗМЕРЫ											
	DIN 11 851	DN	A	B	C	D	E	F	R	L	резьб DIN 405 Rd x s	кг	
		10	17	10	13	22,5						0,02	
		15	17	16	19	28,5							0,03
		20	18	20	23	36,5							0,06
		25	22	26	29	44							0,08
		32	25	32	35	50							0,10
		40	26	38	41	56							0,12
		50	28	50	53	68,5							0,17
		65	32	66	70	86							0,29
		80	37	81	85	100							0,35
		100	44	100	104	121							0,57
		125	34	125	129	150							0,77
		150	37	150	154	176							1,01

РЕЗЬБОВОЕ СОЕДИНЕНИЕ ТИП «Т»	20120 T	ОПИСАНИЕ
		<p>Пищевое резьбовое соединение приварное к т. № 20120-T, DIN 11 851</p> <ul style="list-style-type: none"> – Простой монтаж – Легкая замена уплотнения <p>Размеры: DN 10 – DN 150</p> <p>Резьба: DIN 405</p> <p>Материал: 1.4301 (AISI 304) 1.4404 (AISI 316L)</p> <p>Уплотнение: NBR (стандартное) EPDM Viton Silikon PTFE</p>

КОМПЛЕКТУЮЩИЕ

ТОЛЩИНА СТЕНКИ	
DN 10 - 15	4,0 мм
DN 20	5,0 мм
DN 25 - 32	4,5 мм
DN 40	5,0 мм
DN 50	5,5 мм
DN 65	6,5 мм
DN 80	6,0 мм
DN 100	7,0 мм

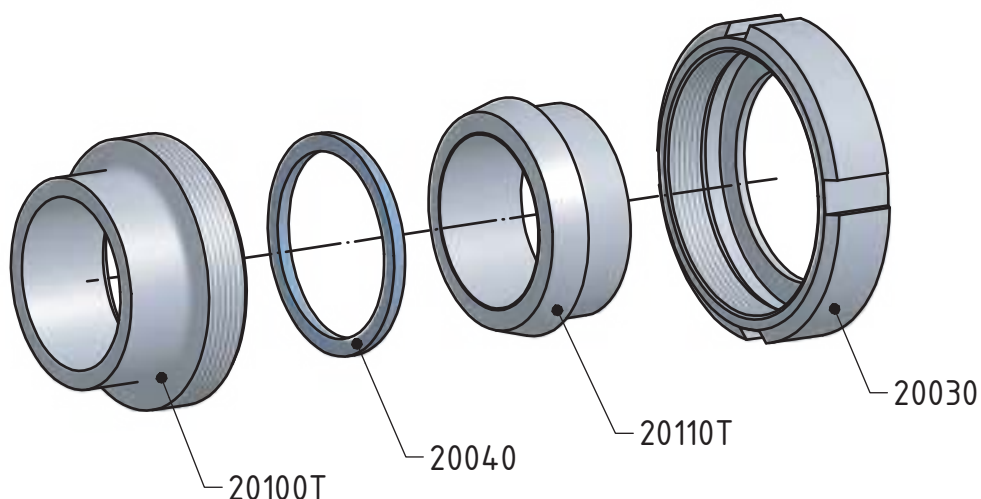

Деталь уплотнения

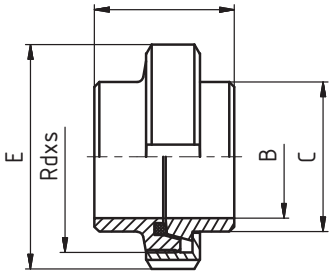
РЕЗЬБОВОЕ СОЕДИНЕНИЕ ПРИВАРНОЕ - КОМПЛЕКТ	20120 T	РАЗМЕРЫ																																																																																																																							
	<table border="1"> <thead> <tr> <th>DN</th> <th>A</th> <th>B</th> <th>C</th> <th>D</th> <th>E</th> <th>F</th> <th>R</th> <th>L</th> <th>резьба DIN 405 Rd x s</th> <th>кг</th> </tr> </thead> <tbody> <tr> <td>10</td> <td>35</td> <td>10</td> <td>18</td> <td></td> <td>38</td> <td></td> <td></td> <td></td> <td>28x1/8"</td> <td>0,19</td> </tr> <tr> <td>15</td> <td>35</td> <td>16</td> <td>24</td> <td></td> <td>44</td> <td></td> <td></td> <td></td> <td>34x1/4"</td> <td>0,19</td> </tr> <tr> <td>20</td> <td>37</td> <td>20</td> <td>30</td> <td></td> <td>54</td> <td></td> <td></td> <td></td> <td>44x1/6"</td> <td>0,34</td> </tr> <tr> <td>25</td> <td>45</td> <td>26</td> <td>35</td> <td></td> <td>63</td> <td></td> <td></td> <td></td> <td>52x1/6"</td> <td>0,45</td> </tr> <tr> <td>32</td> <td>51</td> <td>32</td> <td>41</td> <td></td> <td>70</td> <td></td> <td></td> <td></td> <td>58x1/6"</td> <td>0,57</td> </tr> <tr> <td>40</td> <td>53</td> <td>38</td> <td>48</td> <td></td> <td>78</td> <td></td> <td></td> <td></td> <td>65x1/6"</td> <td>0,69</td> </tr> <tr> <td>50</td> <td>57</td> <td>50</td> <td>61</td> <td></td> <td>92</td> <td></td> <td></td> <td></td> <td>78x1/6"</td> <td>0,96</td> </tr> <tr> <td>65</td> <td>65</td> <td>66</td> <td>79</td> <td></td> <td>112</td> <td></td> <td></td> <td></td> <td>95x1/6"</td> <td>1,58</td> </tr> <tr> <td>80</td> <td>75</td> <td>81</td> <td>93</td> <td></td> <td>127</td> <td></td> <td></td> <td></td> <td>110x1/4"</td> <td>2,20</td> </tr> <tr> <td>100</td> <td>89</td> <td>100</td> <td>114</td> <td></td> <td>148</td> <td></td> <td></td> <td></td> <td>130x1/4"</td> <td>3,12</td> </tr> </tbody> </table>	DN	A	B	C	D	E	F	R	L	резьба DIN 405 Rd x s	кг	10	35	10	18		38				28x1/8"	0,19	15	35	16	24		44				34x1/4"	0,19	20	37	20	30		54				44x1/6"	0,34	25	45	26	35		63				52x1/6"	0,45	32	51	32	41		70				58x1/6"	0,57	40	53	38	48		78				65x1/6"	0,69	50	57	50	61		92				78x1/6"	0,96	65	65	66	79		112				95x1/6"	1,58	80	75	81	93		127				110x1/4"	2,20	100	89	100	114		148				130x1/4"
DN	A	B	C	D	E	F	R	L	резьба DIN 405 Rd x s	кг																																																																																																															
10	35	10	18		38				28x1/8"	0,19																																																																																																															
15	35	16	24		44				34x1/4"	0,19																																																																																																															
20	37	20	30		54				44x1/6"	0,34																																																																																																															
25	45	26	35		63				52x1/6"	0,45																																																																																																															
32	51	32	41		70				58x1/6"	0,57																																																																																																															
40	53	38	48		78				65x1/6"	0,69																																																																																																															
50	57	50	61		92				78x1/6"	0,96																																																																																																															
65	65	66	79		112				95x1/6"	1,58																																																																																																															
80	75	81	93		127				110x1/4"	2,20																																																																																																															
100	89	100	114		148				130x1/4"	3,12																																																																																																															
																																																																																																																									

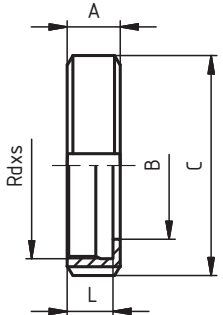
ГАЙКА НАКИДНАЯ	20030	РАЗМЕРЫ										
	DIN 11 851	DN	A	B	C	D	E	F	R	L	резьб DIN 405 Rd x s	кг
		10	18	19	38					15	28x1/8"	0,07
		15	18	25	44					15	34x1/8"	0,08
		20	20	31	54					17	44x1/6"	0,14
		25	21	36	63					18	52x1/6"	0,18
		32	21	42	70					18	58x1/6"	0,22
		40	21	49	78					18	65x1/6"	0,25
		50	22	62	92					19	78x1/6"	0,33
		65	25	80	112					21	95x1/6"	0,55
		80	29	94	127					25	110x1/4"	0,80
		100	31	115	148					26	130x1/4"	1,08
		125	35	138	178					30	160x1/4"	1,45
		150	40	164	210					34	190x1/4"	1,88

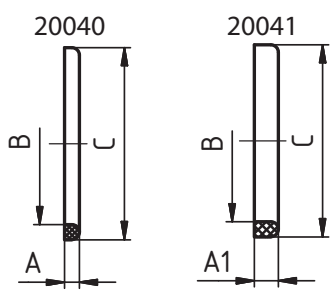
УПЛОТНЕНИЕ	20040	20041	РАЗМЕРЫ										
	DIN 11 851		DN	A	A1	B	C	E	F	R	L	резьб DIN 405 Rd x s	кг
			10	4	-	12	20						0,0012
			15	4	-	18	26						0,0016
			20	4	-	23	33						0,0026
			25	5	8	30	40						0,0036
			32	5	8	36	46						0,0040
			40	5	8	42	52						0,0048
			50	5	8	54	64						0,0062
			65	5	8	71	81						0,0070
			80	5	8	85	95						0,0080
			100	6	8	104	114						0,0134
			125	7	8	130	142						0,0236
			150	7	8	155	167						0,0276

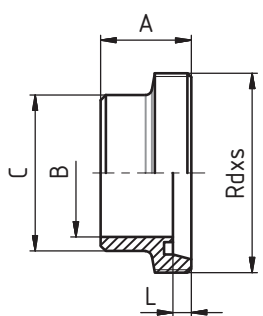
РЕЗЬБОВОЙ ШТУЦЕР ПРИВАРНОЙ	20100 T	РАЗМЕРЫ										
		DN	A	B	C	D	E	F	R	L	резьб DIN 405 Rd x s	кг
		10	21	10	18					4	28x1/8"	0,05
		15	21	16	24					4	34x1/8"	0,07
		20	24	20	30					6	44x1/6"	0,13
		25	29	26	35					7	52x1/6"	0,17
		32	32	32	41					7	58x1/6"	0,21
		40	33	38	48					7	65x1/6"	0,27
		50	35	50	61					7	78x1/6"	0,38
		65	40	66	79					8	95x1/6"	0,61
		80	45	81	93					8	110x1/4"	0,86
		100	54	100	114					10	130x1/4"	1,15

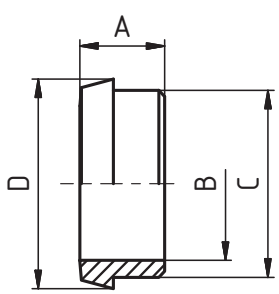
КОНИЧЕСКИЙ ШТУЦЕР ПРИВАРНОЙ	20110 T	РАЗМЕРЫ										
		DN	A	B	C	D	E	F	R	L	резьб DIN 405 Rd x s	кг
		10	17	10	18	22,5						0,03
		15	17	16	24	28,5						0,04
		20	18	20	30	36,5						0,07
		25	22	26	35	44						0,10
		32	25	32	41	50						0,14
		40	26	38	48	56						0,17
		50	28	50	61	68,5						0,25
		65	32	66	79	86						0,42
		80	37	81	93	100						0,54
		100	44	100	114	121						0,89

РЕЗЬБОВОЕ СОЕДИНЕНИЕ ISO	21030	ОПИСАНИЕ
	ISO	
		<p>Пищевое резьбовое соединение ISO к т. № 21030</p> <ul style="list-style-type: none"> – Простой монтаж – Легкая замена уплотнения <p>Размеры: DN 10 – DN 150</p> <p>Резьба: DIN 405</p> <p>Материал: 1.4301 (AISI 304) 1.4404 (AISI 316L)</p> <p>Уплотнение: NBR EPDM (стандартное) Viton Silikon PTFE</p>

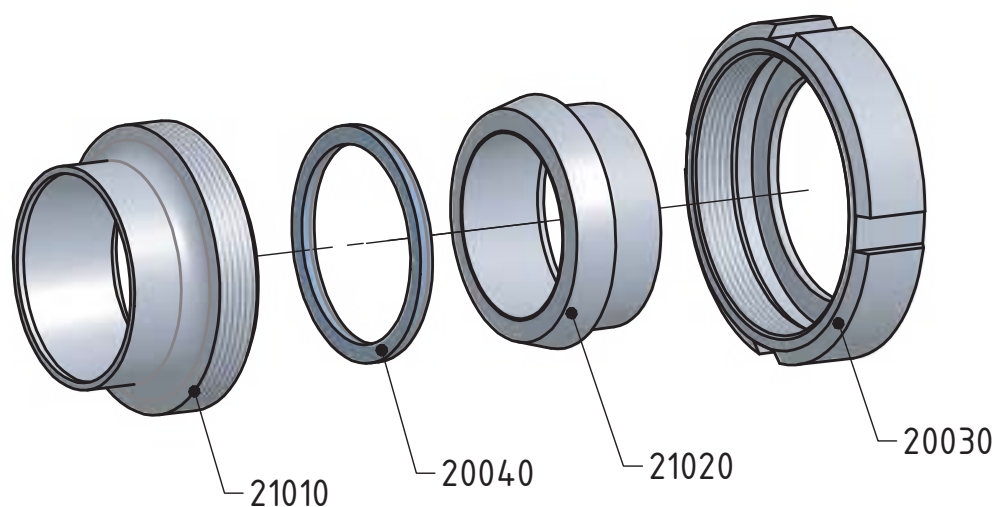
КОМПЛЕКТУЮЩИЕ

Деталь уплотнения

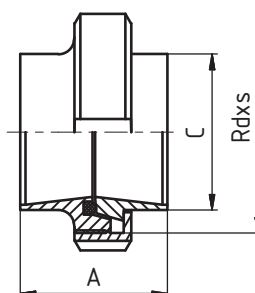
РЕЗЬБОВОЕ СОЕДИНЕНИЕ ISO – КОМПЛЕКТ	21030	РАЗМЕРЫ										
	ISO	DN	A	B	C	D	E	F	R	L	резьба DIN 405 Rd x s	кг
		10	34		18						28x1/8"	0,15
		15	34		21,3						34x1/8"	0,18
		20	36		26,9						44x1/6"	0,30
		25	45		33,7						52x1/6"	0,42
		32	51		42,4						58x1/6"	0,51
		40	53		48,3						65x1/6"	0,61
		50	57		60,3						78x1/6"	0,84
		65	65		76,1						95x1/6"	1,31
		80	75		88,9						110x1/4"	1,80
		100	89		114,3						130x1/4"	2,66

ГАЙКА НАКИДНАЯ	20030	РАЗМЕРЫ										
	DIN 11 851	DN	A	B	C	D	E	F	R	L	резьб DIN 405 Rd x s	кг
		10	18	19	38					15	28x1/8"	0,07
		15	18	25	44					15	34x1/8"	0,08
		20	20	31	54					17	44x1/6"	0,14
		25	21	36	63					18	52x1/6"	0,18
		32	21	42	70					18	58x1/6"	0,22
		40	21	49	78					18	65x1/6"	0,25
		50	22	62	92					19	78x1/6"	0,33
		65	25	80	112					21	95x1/6"	0,55
		80	29	94	127					25	110x1/4"	0,80
		100	31	115	148					26	130x1/4"	1,08
		125	35	138	178					30	160x1/4"	1,45
		150	40	164	210					34	190x1/4"	1,88

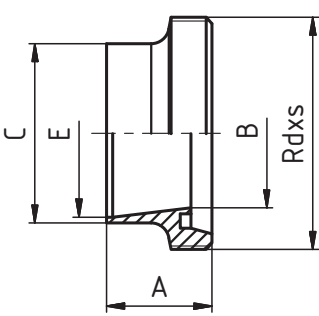
РЕЗЬБОВОЙ ШТУЦЕР ISO	21010	РАЗМЕРЫ										
	ISO	DN	A	B	C	D	E	F	R	L	резьб DIN 405 Rd x s	кг
		10	21	10	18		14			4	28x1/8"	0,04
		15	21	16	21,3		18,1			4	34x1/8"	0,05
		20	24	20	26,9		23,7			6	44x1/6"	0,10
		25	29	26	33,7		29,7			7	52x1/6"	0,13
		32	32	32	42,4		38,4			7	58x1/6"	0,16
		40	33	38	48,3		44,3			7	65x1/6"	0,21
		50	35	50	60,3		56,3			7	78x1/6"	0,30
		65	40	66	76,1		71,5			8	95x1/6"	0,45
		80	45	81	88,9		84,3			8	110x1/4"	0,60
		100	54	100	114,3		109,1			10	130x1/4"	0,78

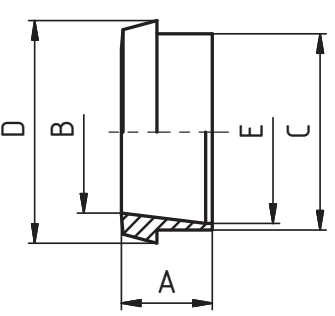
КОНИЧЕСКИЙ ШТУЦЕР ISO	21020	РАЗМЕРЫ											
	ISO	DN	A	B	C	D	E	F	R	L	резьб DIN 405 Rd x s	кг	
		10	17	10	18	22,5	14					0,02	
		15	17	16	21,3	28,5	18,1						0,03
		20	18	20	26,9	36,5	23,7						0,06
		25	22	26	33,7	44	29,7						0,09
		32	25	32	42,4	50	38,4						0,11
		40	26	38	48,3	56	44,3						0,14
		50	28	50	60,3	68,5	56,3						0,21
		65	32	66	76,1	86	71,5						0,32
		80	37	81	88,9	100	84,3						0,39
		100	44	100	114,3	121	109,1						0,59

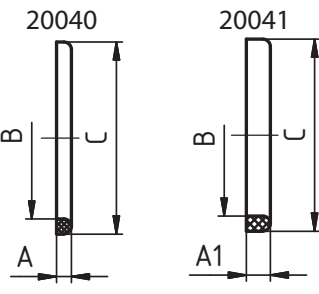
УПЛОТНЕНИЕ	20040	20041	РАЗМЕРЫ									
	DIN 11 851		DN	A	A1	B	C	E	F	R	L	резьб DIN 405 Rd x s
			10	4	-	12	20					0,0012
			15	4	-	18	26					0,0016
			20	4	-	23	33					0,0026
			25	5	8	30	40					0,0036
			32	5	8	36	46					0,0040
			40	5	8	42	52					0,0048
			50	5	8	54	64					0,0062
			65	5	8	71	81					0,0070
			80	5	8	85	95					0,0080
			100	6	8	104	114					0,0134
			125	7	8	130	142					0,0236
			150	7	8	155	167					0,0276

РЕЗЬБОВОЕ СОЕДИНЕНИЕ SMS	21120	ОПИСАНИЕ
	SMS	
		Пищевое резьбовое соединение SMS к т. № 21120 – Простой монтаж – Легкая замена уплотнения
		Размеры: DN 10 – DN 150 Резьба: DIN 405 Материал: 1.4301 (AISI 304) 1.4404 (AISI 316L) Уплотнение: NBR EPDM (стандартное) Viton Silikon PTFE

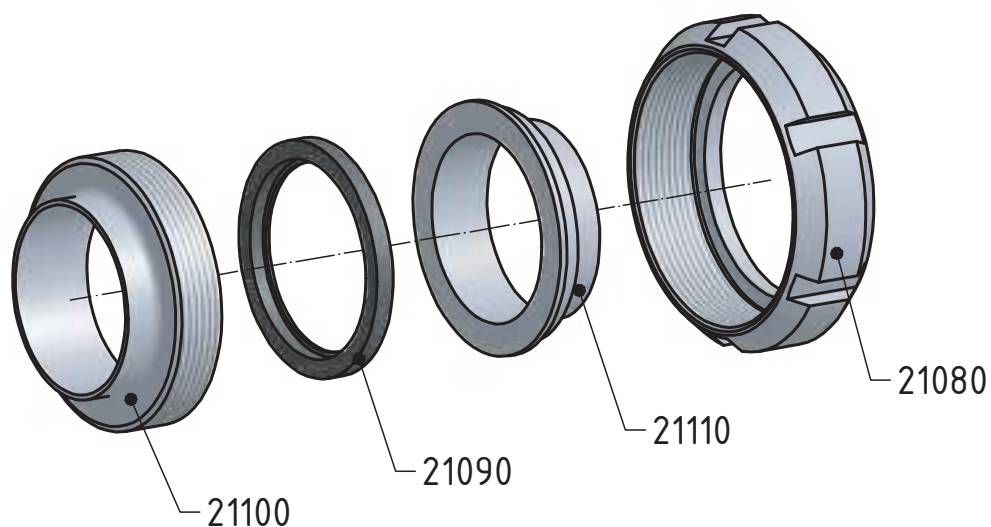
КОМПЛЕКТУЮЩИЕ

Деталь уплотнения

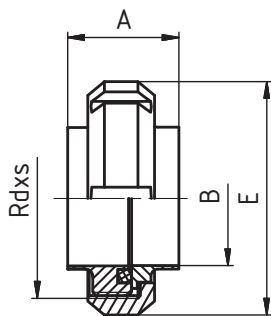
РЕЗЬБОВОЕ СОЕДИНЕНИЕ ПРИВАРНОЕ - КОМПЛЕКТ	21120	РАЗМЕРЫ										
	SMS	DN	A	B	C	D	E	F	R	L	резьба DIN 405 Rd x s	кг
	25	54,5	22,5	25		51					40x1/6	0,18
	38	78	35,5	38,1		74					60x1/6	0,47
	51	88	48,5	51		84					70x1/6	0,55
	63,5	107	60,5	63,5		100					85x1/6	0,83
	76	120	72,9	76,1		114					98x1/6	1,13
	101,6	148	97,6	101,6		138					125x1/4	2,78
	104	148	100	104		138					125x1/4	2,78

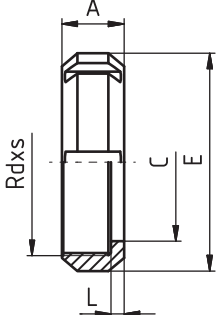
ГАЙКА НАКИДНАЯ SMS	21080	РАЗМЕРЫ										
	SMS	DN	A	B	C	D	E	F	R	L	резьб DIN 405 Rd x s	кг
	25	19		32		51				4	40x1/6"	0,11
	38	23		48		74				4	60x1/6"	0,26
	51	24		60,5		84				5	70x1/6"	0,31
	63,5	28		74		100				5	85x1/6"	0,41
	76	30		87		114				6	98x1/6"	0,57
	101,6	31		113		138				5	125x1/4"	1,20
	104	31		113		138				5	125x1/4"	1,22

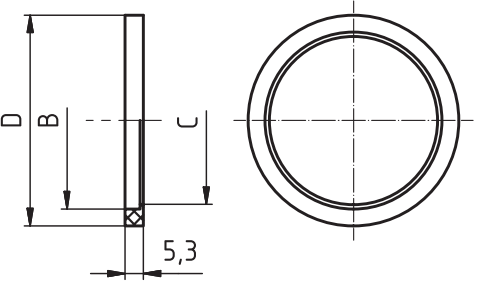
УПЛОТНЕНИЕ SMS	21090	РАЗМЕРЫ										
	SMS	DN	A	B	C	D	E	F	R	L	резьб DIN 405 Rd x s	кг
	25		25,1	22,8	31,8							
	38		38,1	35,8	47,8							
	51		51,1	48,8	60,8							
	63,5		63,6	61	73,3							
	76		76,1	73,4	85,8							
	104		104	100,5	115,7							

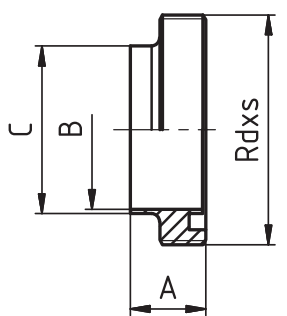
РЕЗЬБОВОЙ ШТУЦЕР ПРИВАРНОЙ SMS	21100	РАЗМЕРЫ										
	SMS	DN	A	B	C	D	E	F	R	L	резьб DIN 405 Rd x s	кг
	25	19	22,5	25							40x1/6"	0,05
	38	23	35,5	38							60x1/6"	0,17
	51	23	48,5	51							70x1/6"	0,18
	63,5	27	60,5	63,5							85x1/6"	0,35
	76	27	72,9	76,1							98x1/6"	0,44
	101,6	30	97,6	101,6							125x1/4"	1,31
	104	30	100	104							125x1/4"	1,32

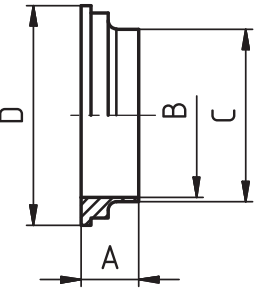
КОНИЧЕСКИЙ ШТУЦЕР ПРИВАРНОЙ SMS	21110	РАЗМЕРЫ										
	SMS	DN	A	B	C	D	E	F	R	L	резьб DIN 405 Rd x s	кг
	25	15,5	22,5	25	35,5							0,02
	38	16	35,5	38	55							0,04
	51	17	48,5	50,8	65							0,06
	63,5	17	60,5	63,5	80							0,08
	76	19	72,9	76,1	93							0,12
	101,6	19	97,6	101,6	118							0,27
	104	19	100	104	118							0,29

СОЕДИНЕНИЕ КЛАМП DIN	21250	ОПИСАНИЕ
	DIN 32 676	
		Соединение Кл мп DIN к т. № 21250 – Простой монтаж – Легкая замена уплотнения Размеры: DN 10 – DN 150 Материал: 1.4301 (AISI 304) 1.4404 (AISI 316L) Уплотнение: Silikon (стандартное) PTFE – Viton Viton EPDM

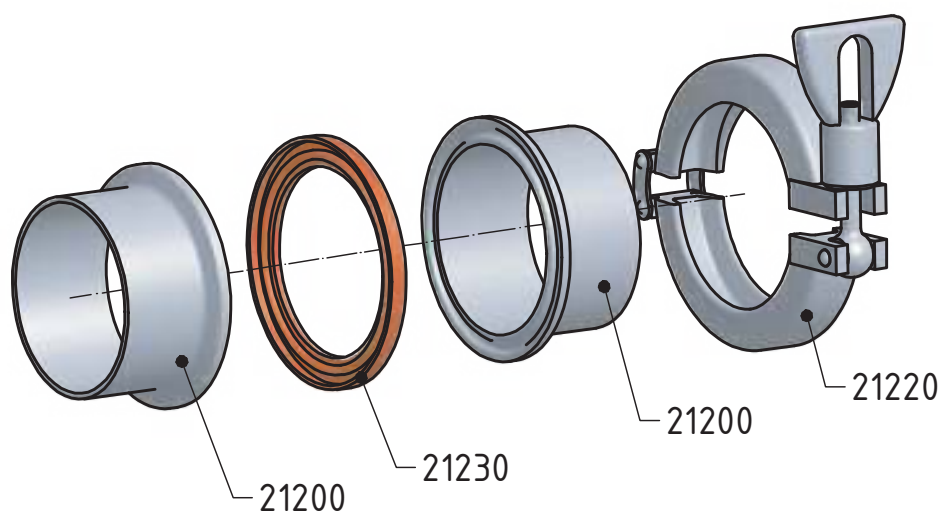
КОМПЛЕКТУЮЩИЕ

Деталь уплотнения

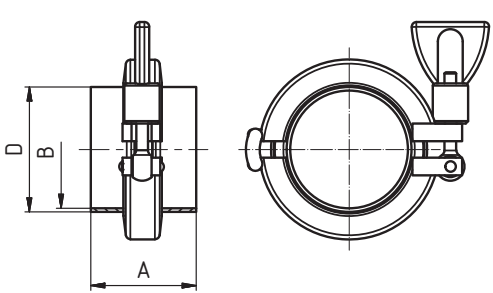
СОЕДИНЕНИЕ КЛАМП - КОМПЛЕКТ	21250	РАЗМЕРЫ										
	DIN 32 676	DN	A	B	C	D	E	F	R	L	резьб. DIN 405 Rd x s	кг
		10	38	10		13						0,28
		15	38	16		19						0,28
		20	38	20		23						0,30
		25	45	26		29						0,35
		32	45	32		35						0,35
		40	45	38		41						0,37
		50	45	50		53						0,39
		65	58	66		70						0,89
		80	58	81		85						0,95
		100	58	100		104						0,99
		125	58	125		129						1,15
		150	58	150		154						1,30

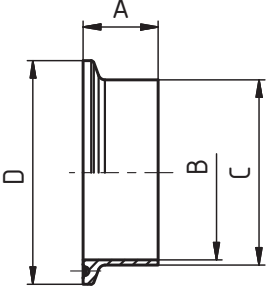
ПАТРУБОК КЛАМП	21200		РАЗМЕРЫ									
	DIN 32 676		DN	A	B	C	D	E	F	R	L	резьб DIN 405 Rd x s
	10	18	10	13	34							0,03
	15	18	16	19	34							0,03
	20	18	20	23	34							0,03
	25	21,5	26	29	50,5							0,07
	32	21,5	32	35	50,5							0,07
	40	21,5	38	41	50,5							0,07
	50	21,5	50	53	64							0,07
	65	28	66	70	91							0,10
	80	28	81	85	106							0,20
	100	28	100	104	119							0,22
	125	28	125	129	155							0,52
	150	28	150	154	183							0,70

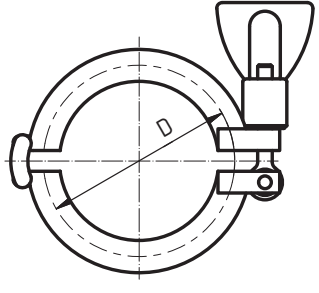
ХОМУТ КЛАМП	21220		РАЗМЕРЫ						
	DIN 32 676		DN	SMS	DIN	D	DN	SMS	DIN
	1/2"-3/4"	12,7	-	25	80	-	80	106	
	1/2"-3/4"	19,05	-	25	4"	101,6	100	119	
	10-20	-	10-20	34	125	-	125	155	
	1"-1 1/2"	25	25	50,5	6"	-	-	166,8	
	1"-1 1/2"	-	32	50,5	150	-	150	183	
	1"-1 1/2"	38	40	50,5	8"	-	-	217,6	
	2"	51	50	64	200	-	200	233,5	
	2 1/2"	63,5	-	77,5	250	-	250	268	
	3"	76,1	65	91	300	-	300	318,5	

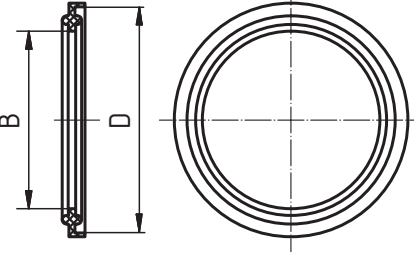
УПЛОТНЕНИЕ КЛАМП	21230		РАЗМЕРЫ									
	DIN 32 676		DN	A	B	C	D	E	F	R	L	резьб DIN 405 Rd x s
	10				10,2		34					
	15				16,2		34					
	20				20,2		34					
	25				26,2		50,5					
	32				32,2		50,5					
	40				38,2		50,5					
	50				50,2		64					
	65				66,2		91					
	80				81,2		106					
	100				100,2		119					

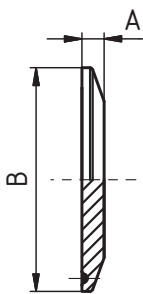
КЛАМП ГЛУХОЙ DIN / SMS	21240		РАЗМЕРЫ									
	DIN 32 676 / SMS		DN	A	B	C	D	E	F	R	L	резьб DIN 405 Rd x s
	10	6,35	34									0,04
	15	6,35	34									0,04
	20	6,35	34									0,04
	25	6,35	50,5									0,08
	32	6,35	50,5									0,08
	40	6,35	50,5									0,08
	50	6,35	64									0,14
	65	6,35	91									0,28
	80	6,35	106									0,46
	100	7,95	119									0,60
	125	7,95	155									1,15
	150	11,00	183									2,20

СОЕДИНЕНИЕ КЛАМП SMS	21252	ОПИСАНИЕ
	SMS	
		<p>Соединение Кл мп SMS к т. № 21252</p> <ul style="list-style-type: none"> – Простой монтаж – Легкая замена уплотнения <p>Размеры: DN 10 – DN 150</p> <p>Материал: 1.4301 (AISI 304) 1.4404 (AISI 316L)</p> <p>Уплотнение: Silikon (стандартное) PTFE – Viton Viton EPDM</p>

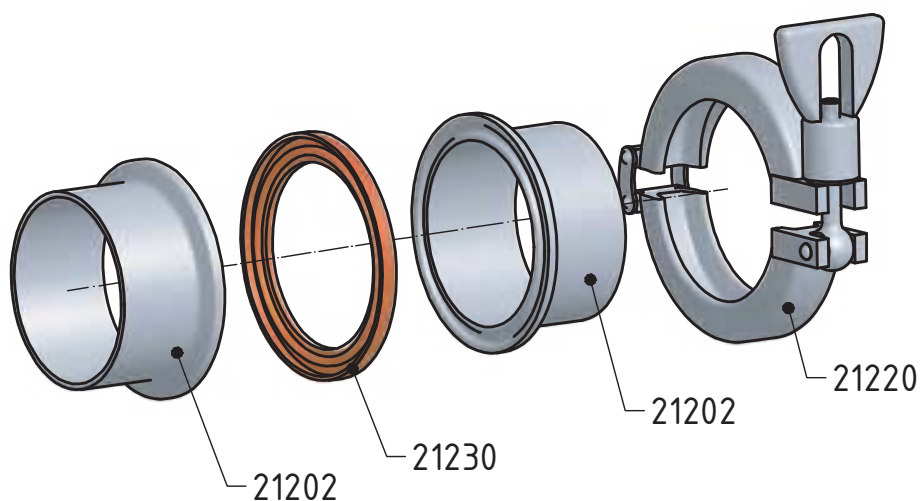
КОМПЛЕКТУЮЩИЕ

Деталь уплотнения

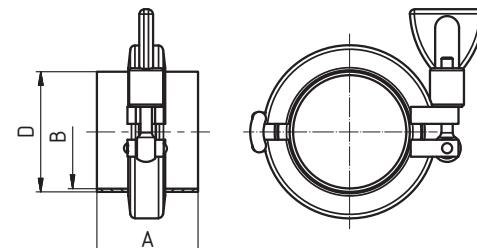
СОЕДИНЕНИЕ КЛАМП SMS - КОМПЛЕКТ	21252	РАЗМЕРЫ										
	SMS	DN	A	B	C	D	E	F	R	L	резьб. DIN 405 Rd x s	кг
		25	43	22,5		25						0,35
		38	43	35,5		38,1						0,37
		51	43	48,5		51						0,39
		63,5	56	60,5		63,5						0,89
		76	56	72,9		76,1						0,95
		101,6	56	97,6		101,6						0,99

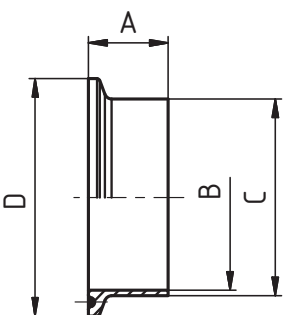
ПАТРУБОК КЛАМП SMS	21202		РАЗМЕРЫ											
	SMS	DN	SMS	A	B	C	D	F	R	L	резьб Rd x s	DIN 405	кг	
	1/2"	12,7	21,5	9,4	12,7	25							0,03	
	3/4"	19,05	21,5	15,75	19,05	25							0,03	
	1"	25	21,5	22,5	25	50,5							0,07	
	1 1/2"	38,1	21,5	35,5	38,1	50,5							0,07	
	2"	51	21,5	48,5	51	64							0,07	
	2 1/2"	63,5	28	60,5	63,5	77,5							0,1	
	3"	76,1	28	72,9	76,1	91							0,2	
	4"	101,6	28	97,6	101,6	119							0,22	

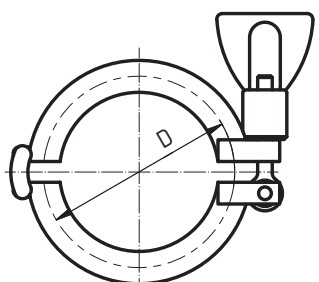
ХОМУТ КЛАМП	21220		РАЗМЕРЫ							
	DIN 32 676	DN	SMS	DIN	D	DN	SMS	DIN	D	
	1/2"-3/4"	12,7	-	25	80	-	80	106		
	1/2"-3/4"	19,05	-	25	4"	101,6	100	119		
	10-20	-	10-20	34	125	-	125	155		
	1"-1 1/2"	25	25	50,5	6"	-	-	166,8		
	1"-1 1/2"	-	32	50,5	150	-	150	183		
	1"-1 1/2"	38	40	50,5	8"	-	-	217,6		
	2"	51	50	64	200	-	200	233,5		
	2 1/2"	63,5	-	77,5	250	-	250	268		
	3"	76,1	65	91	300	-	300	318,5		

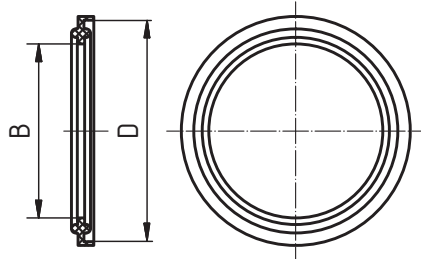
УПЛОТНЕНИЕ КЛАМП SMS	21232		РАЗМЕРЫ											
	SMS	DN	SMS	B	C	D	E	F	R	L	резьб Rd x s	DIN 405	кг	
	1/2"	12,7	9,3			25								
	3/4"	19,05	15,7			25								
	1"	25	22,3			50,5								
	1 1/2"	38,1	35			50,5								
	2"	51	47,7			64								
	2 1/2"	63,5	60,4			77,5								
	3"	76,1	73,1			91								
	4"	101,6	97,6			119								

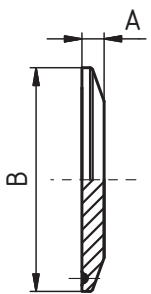
КЛАМП ГЛУХОЙ DIN / SMS	21242		РАЗМЕРЫ											
	DIN 32 676 / SMS	DN	SMS	A	B	D	E	F	R	L	резьб Rd x s	DIN 405	кг	
	1/2"	12,7	6,35	25									0,04	
	3/4"	19,05	6,35	25									0,04	
	1"	25	6,35	50,5									0,08	
	1 1/2"	38,1	6,35	50,5									0,08	
	2"	51	6,35	64									0,14	
	2 1/2"	63,5	6,35	77,5									0,28	
	3"	76,1	6,35	91									0,46	
	4"	101,6	7,95	119									0,6	

ГИГИЕНИЧЕСКОЕ РЕЗЬБОВОЕ СОЕДИНЕНИЕ	22320	ОПИСАНИЕ
	DIN 11 853	
		Гигиеническое резьбовое соединение приварное к т. № 22320, DIN 11 853-1 – Простой монтаж – Легкая замена уплотнения
		Размеры: DN 10 – DN 100 Резьба: DIN 405 Материал: 1.4301 (AISI 304) 1.4404 (AISI 316L) Уплотнение: NBR EPDM (стандартное) Viton

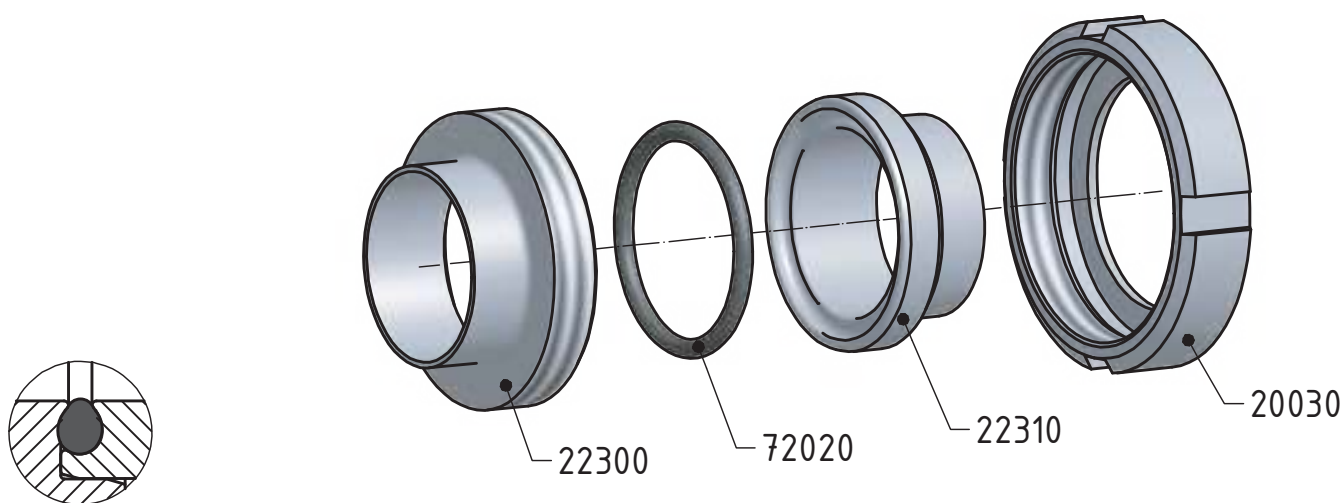
КОМПЛЕКТУЮЩИЕ

Деталь уплотнения

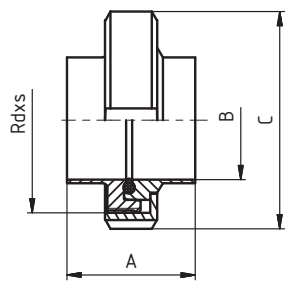
РЕЗЬБОВОЕ СОЕДИНЕНИЕ ПРИВАРНОЕ – КОМПЛЕКТ	22320	РАЗМЕРЫ										
	DIN 11 853	DN	A	B	C	D	E	F	R	L	резьба DIN 405 Rd x s	кг
	10	32	10	38							28x1/8"	0,14
	15	32	16	44							34x1/8"	0,18
	20	34	20	54							44x1/6"	0,30
	25	42	26	63							52x1/6"	0,41
	32	48	32	70							58x1/6"	0,48
	40	50	38	78							65x1/6"	0,57
	50	54	50	92							78x1/6"	0,78
	65	62	66	112							95x1/6"	1,27
	80	72	81	127							110x1/4"	1,76
	100	86	100	148							130x1/4"	2,40

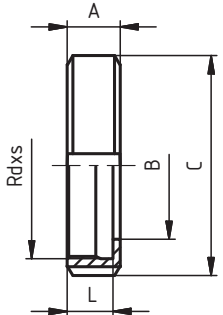
ГАЙКА НАКИДНАЯ	20030	РАЗМЕРЫ										
	DIN 11 851	DN	A	B	C	D	E	F	R	L	резьб DIN 405 Rd x s	кг
	10	18	19	38						15	28x1/8"	0,07
	15	18	25	44						15	34x1/8"	0,08
	20	20	31	54						17	44x1/6"	0,14
	25	21	36	63						18	52x1/6"	0,18
	32	21	42	70						18	58x1/6"	0,22
	40	21	49	78						18	65x1/6"	0,25
	50	22	62	92						19	78x1/6"	0,33
	65	25	80	112						21	95x1/6"	0,55
	80	29	94	127						25	110x1/4"	0,80
	100	31	115	148						26	130x1/4"	1,08
	125	35	138	178						30	160x1/4"	1,45
	150	40	164	210						34	190x1/4"	1,88

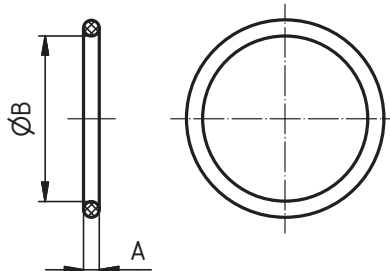
УПЛОТНЕНИЕ	72020	РАЗМЕРЫ										
	DIN 11 853	DN	A	B	C	D	E	F	R	L	резьб DIN 405 Rd x s	кг
	10	3,5	12									
	15	3,5	18									
	20	3,5	22									
	25	3,5	28									
	32	5	34									
	40	5	40									
	50	5	52									
	65	5	68									
	80	5	83									
	100	5	102									

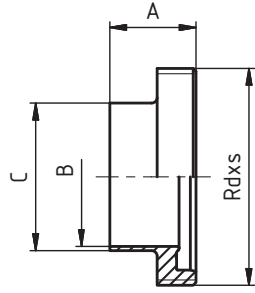
РЕЗЬБОВОЙ ШТУЦЕР ПРИВАРНОЙ	22300	РАЗМЕРЫ										
	DIN 11 853	DN	A	B	C	D	E	F	R	L	резьб DIN 405 Rd x s	кг
	10	19	10	13							28x1/8"	0,04
	15	19	16	19							34x1/8"	0,06
	20	21	20	23							44x1/6"	0,11
	25	26	26	29							52x1/6"	0,15
	32	30	32	35							58x1/6"	0,17
	40	31	38	41							65x1/6"	0,20
	50	31	50	53							78x1/6"	0,26
	65	36	66	70							95x1/6"	0,40
	80	42	81	85							110x1/4"	0,63
	100	50	100	104							130x1/4"	0,76

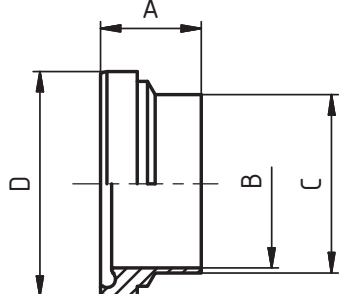
КОНИЧЕСКИЙ ШТУЦЕР ПРИВАРНОЙ	22310	РАЗМЕРЫ										
	DIN 11 853	DN	A	B	C	D	E	F	R	L	резьб DIN 405 Rd x s	кг
	10	17	10	13	21,9							0,02
	15	17	16	19	27,9							0,03
	20	18	20	23	35,9							0,05
	25	22	26	29	42,9							0,08
	32	25	32	35	48,9							0,09
	40	26	38	41	54,9							0,11
	50	30	50	53	66,9							0,16
	65	34	66	70	84,9							0,30
	80	38	81	85	98,9							0,35
	100	46	100	104	118,9							0,57

АСЕПТИЧЕСКОЕ РЕЗЬБОВОЕ СОЕДИНЕНИЕ	22490	ОПИСАНИЕ
	DIN 11 864-1-A	
		<p>Асептическое резьбовое соединение приварное к т. № 22490, DIN 11 864-1</p> <ul style="list-style-type: none"> – Простой монтаж – Легкая замена уплотнения <p>Размеры: DN 10 – DN 100</p> <p>Резьба: DIN 405</p> <p>Материал: 1.4301 (AISI 304) 1.4404 (AISI 316L)</p> <p>Уплотнение: NBR EPDM (стандартное) Viton</p>

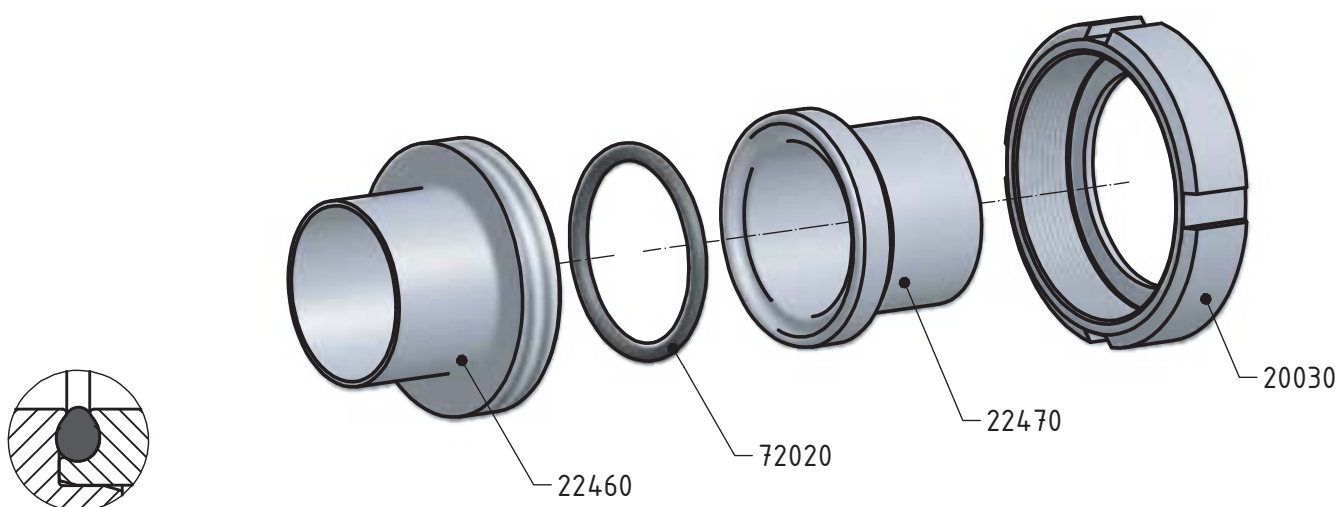
КОМПЛЕКТУЮЩИЕ

Деталь уплотнения

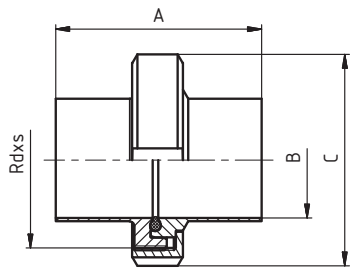
РЕЗЬБОВОЕ СОЕДИНЕНИЕ ПРИВАРНОЕ – КОМПЛЕКТ	22490	РАЗМЕРЫ										
	DIN 11 864-1-A	DN	A	B	C	D	E	F	R	L	резьба DIN 405 Rd x s	кг
	10	76	10	38							28x1/8"	0,08
	15	76	16	44							34x1/8"	0,11
	20	76	20	54							44x1/6"	0,19
	25	77	26	63							52x1/6"	0,26
	32	88	32	70							58x1/6"	0,31
	40	88	38	78							65x1/6"	0,36
	50	89	50	92							78x1/6"	0,50
	65	113	66	112							95x1/6"	0,86
	80	117	81	127							110x1/4"	1,16
	100	120	100	148							130x1/4"	1,51

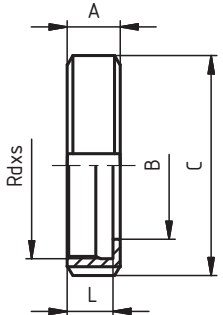
ГАЙКА НАКИДНАЯ	20030	РАЗМЕРЫ										
	DIN 11 851	DN	A	B	C	D	E	F	R	L	резьб DIN 405 Rd x s	кг
	10	18	19	38						15	28x1/8"	0,07
	15	18	25	44						15	34x1/8"	0,08
	20	20	31	54						17	44x1/6"	0,14
	25	21	36	63						18	52x1/6"	0,18
	32	21	42	70						18	58x1/6"	0,22
	40	21	49	78						18	65x1/6"	0,25
	50	22	62	92						19	78x1/6"	0,33
	65	25	80	112						21	95x1/6"	0,55
	80	29	94	127						25	110x1/4"	0,80
	100	31	115	148						26	130x1/4"	1,08
	125	35	138	178						30	160x1/4"	1,45
	150	40	164	210						34	190x1/4"	1,88

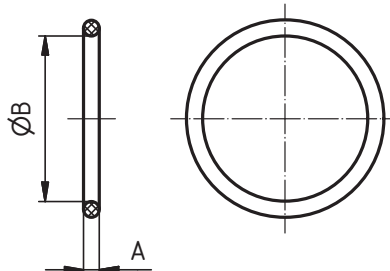
УПЛОТНЕНИЕ	72020	РАЗМЕРЫ										
	DIN 11 864	DN	A	B	C	D	E	F	R	L	резьб DIN 405 Rd x s	кг
	10	3,5	12									
	15	3,5	18									
	20	3,5	22									
	25	3,5	28									
	32	5	34									
	40	5	40									
	50	5	52									
	65	5	68									
	80	5	83									
	100	5	102									

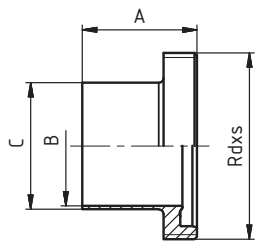
РЕЗЬБОВОЙ ШТУЦЕР ПРИВАРНОЙ	22460	РАЗМЕРЫ										
	DIN 11 864-1-A	DN	A	B	C	D	E	F	R	L	резьб DIN 405 Rd x s	кг
	10	41	10	13							28x1/8"	0,05
	15	41	16	19							34x1/8"	0,07
	20	43	20	23							44x1/6"	0,13
	25	43	26	29							52x1/6"	0,16
	32	48	32	35							58x1/6"	0,19
	40	48	38	41							65x1/6"	0,22
	50	48	50	53							78x1/6"	0,30
	65	60	66	70							95x1/6"	0,48
	80	64	81	85							110x1/4"	0,72
	100	64	100	104							130x1/4"	0,84

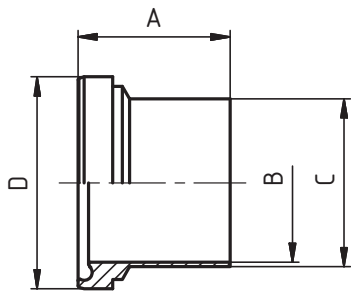
КОНИЧЕСКИЙ ШТУЦЕР ПРИВАРНОЙ	22470	РАЗМЕРЫ										
	DIN 11 864-1-A	DN	A	B	C	D	E	F	R	L	резьб DIN 405 Rd x s	кг
	10	39	10	13	21,9							0,03
	15	39	16	19	27,9							0,04
	20	38	20	23	35,9							0,06
	25	40	26	29	42,9							0,10
	32	47	32	35	48,9							0,12
	40	47	38	41	54,9							0,14
	50	48	50	53	66,9							0,20
	65	61	66	70	84,9							0,38
	80	61	81	85	98,9							0,44
	100	66	100	104	118,9							0,67

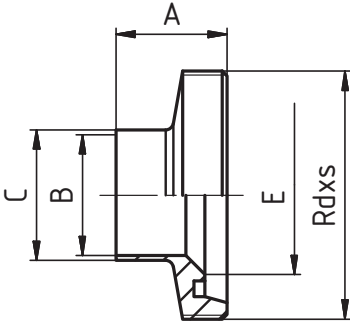
РЕЗЬБОВОЙ ШТУЦЕР ПЕРЕХОДНОЙ	20230	РАЗМЕРЫ										резьб. DIN 405 Rd x s	кг
		DN	A	B	C	D	E	F	R	L			
	20/10	24	10	13		20						44x1/6"	
	20/15	24	16	19		20						44x1/6"	
	25/10	29	10	13		26						52x1/6"	
	25/15	29	16	19		26						52x1/6"	
	25/20	29	20	23		26						52x1/6"	
	32/15	32	16	19		32						58x1/6"	
	32/20	32	20	23		32						58x1/6"	
	32/25	32	26	29		32						58x1/6"	
	40/20	33	20	23		38						65x1/6"	
	40/25	33	26	29		38						65x1/6"	
	40/32	33	32	35		38						65x1/6"	
	50/20	35	20	23		50						78x1/6"	
	50/25	35	26	29		50						78x1/6"	
	50/32	35	32	35		50						78x1/6"	
	50/40	35	38	41		50						78x1/6"	
	65/40	40	38	41		66						95x1/6"	
	65/50	40	50	53		66						95x1/6"	
	80/40	45	38	41		81						110x1/4"	
	80/50	45	50	53		81						110x1/4"	
80/65	45	66	70		81						110x1/4"		
100/50	54	50	53		100						130x1/4"		
100/65	54	66	70		100						130x1/4"		
100/80	54	81	85		100						130x1/4"		

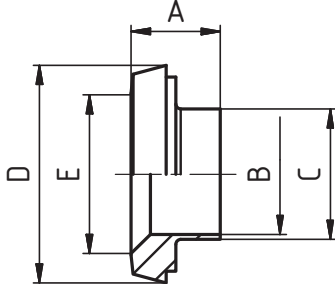
КОНИЧЕСКИЙ ШТУЦЕР ПЕРЕХОДНОЙ	20240	РАЗМЕРЫ										резьб. DIN 405 Rd x s	кг
		DN	A	B	C	D	E	F	R	L			
	20/10	18	10	13	36,5	20							
	20/15	18	16	19	36,5	20							
	25/10	22	10	13	44	26							
	25/15	22	16	19	44	26							
	25/20	22	20	23	44	26							
	32/15	25	16	19	50	32							
	32/20	25	20	23	50	32							
	32/25	25	26	29	50	32							
	40/20	26	20	23	56	38							
	40/25	26	26	29	56	38							
	40/32	26	32	35	56	38							
	50/20	28	20	23	68,5	50							
	50/25	28	26	29	68,5	50							
	50/32	28	32	35	68,5	50							
	50/40	28	38	41	68,5	50							
	65/40	32	38	41	86	66							
	65/50	32	50	53	86	66							
	80/40	37	38	41	100	81							
	80/50	37	50	53	100	81							
80/65	37	66	70	100	81								
100/50	44	50	53	121	100								
100/65	44	66	70	121	100								
100/80	44	81	85	121	100								

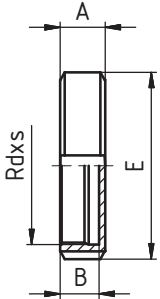
ГАЙКА ГЛУХАЯ	20250	РАЗМЕРЫ										резьб. DIN 405 Rd x s	кг
		DN	A	B	C	D	E	F	R	L			
	10	18	15			38						28x1/8"	0,08
	15	18	15			44						34x1/8"	0,10
	20	20	17			54						44x1/6"	0,14
	25	21	18			63						52x1/6"	0,19
	32	21	18			70						58x1/6"	0,23
	40	21	18			78						65x1/6"	0,26
	50	22	19			92						78x1/6"	0,38
	65	25	21			112						95x1/6"	0,66
	80	29	25			127						110x1/4"	1,00
	100	31	26			148						130x1/4"	1,40
	125	35	30			178						160x1/4"	1,97
	150	40	34			210						190x1/4"	2,87

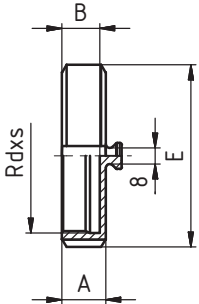
ГАЙКА ГЛУХАЯ С ЦАПФОЙ	20260		РАЗМЕРЫ									
	DN	A	B	C	D	E	F	R	L	резьб DIN 405 Rd x s	кг	
	10	18	15			38				28x1/8"	0,09	
	15	18	15			44				34x1/8"	0,11	
	20	20	17			54				44x1/6"	0,15	
	25	21	18			63				52x1/6"	0,20	
	32	21	18			70				58x1/6"	0,24	
	40	21	18			78				65x1/6"	0,27	
	50	22	19			92				78x1/6"	0,39	
	65	25	21			112				95x1/6"	0,67	
	80	29	25			127				110x1/4"	1,01	
	100	31	26			148				130x1/4"	1,41	
	125	35	30			178				160x1/4"	1,98	
	150	40	34			210				190x1/4"	2,88	

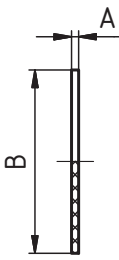
УПЛОТНЕНИЕ ДЛЯ ГЛУХИХ ГАЕК	20270		РАЗМЕРЫ									
	DN	A	B	C	D	E	F	R	L	резьб DIN 405 Rd x s	кг	
	10	3	28									
	15	3	34									
	20	3	44									
	25	3	52									
	32	3	58									
	40	3	65									
	50	3	78									
	65	3	95									
	80	3	110									
	100	3	130									
	125	4	160									
150	4	190										

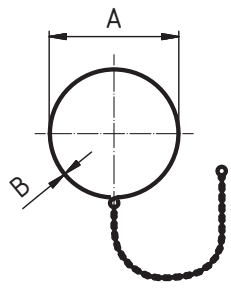
ЦЕПОЧКА ДЛЯ ГЛУХОЙ ГАЙКИ	20280		РАЗМЕРЫ									
	DN	A	B	C	D	E	F	R	L	резьб DIN 405 Rd x s	кг	
	10	18	1,25									
	15	24	1,25									
	20	28	1,25									
	25	34	1,25									
	32	41	1,25									
	40	46	1,25									
	50	57	1,25									
	65	75	1,4									
	80	93	1,6									
	100	113	1,6									
	125	136	3									
	150	166	3									

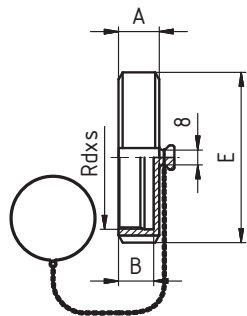
ГАЙКА ГЛУХАЯ С ЦЕПОЧКОЙ И ПРОКЛАДКОЙ	20290		РАЗМЕРЫ									
	DN	A	B	C	D	E	F	R	L	резьб DIN 405 Rd x s	кг	
	10	18	15			38				28x1/8"	0,12	
	15	18	15			44				34x1/8"	0,15	
	20	20	17			54				44x1/6"	0,19	
	25	21	18			63				52x1/6"	0,25	
	32	21	18			70				58x1/6"	0,29	
	40	21	18			78				65x1/6"	0,33	
	50	22	19			92				78x1/6"	0,46	
	65	25	21			112				95x1/6"	0,85	
	80	29	25			127				110x1/4"	1,11	
	100	31	26			148				130x1/4"	1,53	
	125	35	30			178				160x1/4"	2,12	
	150	40	34			210				190x1/4"	3,05	

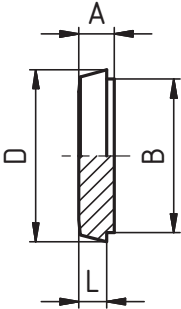
КОНИЧЕСКИЙ ШТУЦЕР ГЛУХОЙ	20300		РАЗМЕРЫ									
	DN	A	B	C	D	E	F	R	L	резьб DIN 405 Rd x s	кг	
	10	9	18		22,5				6		0,02	
	15	9	24		28,5				6		0,04	
	20	11	30		36,5				8		0,07	
	25	13	35		44				10		0,13	
	32	13	41		50				10		0,17	
	40	13	48		56				10		0,22	
	50	14	61		68,5				11		0,35	
	65	16	79		86				12		0,67	
	80	16	93		100				12		0,92	
	100	20	114		121				15		1,34	
	125	22	137		150				17		1,68	
	150	24	163		176				18		4,30	

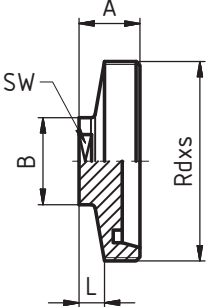
РЕЗЬБОВОЙ ШТУЦЕР ГЛУХОЙ	20330		РАЗМЕРЫ									
	DN	A	B	C	D	E	F	L	SW	резьб DIN 405 Rd x s	кг	
	10	22	22					10	19	28x1/8"	0,06	
	15	22	25					10	22	34x1/8"	0,09	
	20	24	25					10	22	44x1/6"	0,13	
	25	24	34					10	27	52x1/6"	0,19	
	32	24	34					10	27	58x1/6"	0,22	
	40	24	34					10	27	65x1/6"	0,25	
	50	24	34					10	27	78x1/6"	0,35	
	65	28	34					10	27	95x1/6"	0,64	
	80	30	34					10	27	110x1/4"	1,30	
	100	30	34					10	27	130x1/4"	2,10	

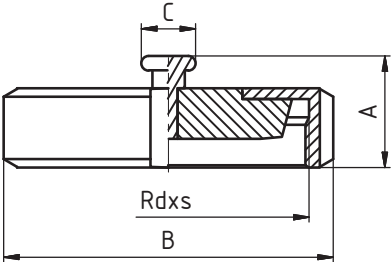
ГАЙКА ГЛУХАЯ С КОНУСОМ	20340		РАЗМЕРЫ									
	DN	A	B	C	D	E	F	R	SW	резьб DIN 405 Rd x s	кг	
	10	27	38	15						28x1/8"	0,12	
	15	27	44	15						34x1/8"	0,15	
	20	29	54	15						44x1/6"	0,22	
	25	30	63	15						52x1/6"	0,32	
	32	30	70	15						58x1/6"	0,40	
	40	30	78	15						65x1/6"	0,49	
	50	31	92	15						78x1/6"	0,73	
	65	34	112	20						95x1/6"	1,25	
	80	38	127	20						110x1/4"	1,70	
	100	40	148	20						130x1/4"	2,79	
	125	44	178	20						160x1/4"	4,39	
150	49	210	20						190x1/4"	6,54		

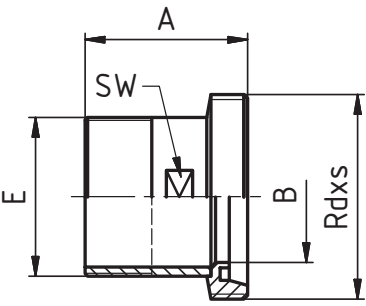
РЕЗЬБОВОЙ ШТУЦЕР ПЕРЕХОДНОЙ	20350		РАЗМЕРЫ									
	DN	A	B	C	D	E	F	R	SW	резьб DIN 405 Rd x s	кг	
	10	40	10			3/8"			15	28x1/8"	0,06	
	15	43	16			1/2"			20	34x1/8"	0,09	
	20	47	20			3/4"			25	44x1/6"	0,15	
	25	52	26			1"			32	52x1/6"	0,21	
	25	54	26			3/4"			25	52x1/6"	0,20	
	32	54	32			1"			32	58x1/6"	0,23	
	32	54	32			1 1/4"			40	58x1/6"	0,25	
	40	54	38			1 1/2"			45	65x1/6"	0,32	
	50	57	50			2"			57	78x1/6"	0,43	
	65	66	66			2 1/2"			73	95x1/6"	0,65	
	80	75	81			3"			86	110x1/4"	1,00	
	100	83	100			4"			110	130x1/4"	1,33	

КОНИЧЕСКИЙ ШТУЦЕР ПЕРЕХОДНОЙ	20360		РАЗМЕРЫ									
	DN	A	B	C	D	E	F	R	SW	резьб. DIN 405 Rd x s	кг	
	10	37	10		22,5	3/8"			15		0,04	
	15	40	16		28,5	1/2"			20		0,06	
	20	47	20		36,5	3/4"			25		0,11	
	25	50	26		44	1"			32		0,16	
	32	54	32		50	1 1/4"			40		0,19	
	40	54	38		56	1 1/2"			45		0,25	
	50	57	50		68,5	2"			57		0,35	
	65	66	66		86	2 1/2"			73		0,55	
	80	75	81		100	3"			86		0,72	
	100	83	100		121	4"			110		1,12	

РЕЗЬБОВОЙ ШТУЦЕР ПЕРЕХОДНОЙ	20370		РАЗМЕРЫ									
	DN	A	B	C	D	E	F	R	SW	резьб. DIN 405 Rd x s	кг	
	10	31	10	20,5		3/8"			19	28x1/8"	0,06	
	15	31	16	25		1/2"			24	34x1/8"	0,08	
	20	35	20	32		3/4"			30	44x1/6"	0,15	
	25	38	26	37		1"			35	52x1/6"	0,19	
	32	40	32	46		1 1/4"			44	58x1/6"	0,23	
	40	41	38	52,5		1 1/2"			51	65x1/6"	0,28	
	50	43	50	65,5		2"			63	78x1/6"	0,41	
	65	50	66	81		2 1/2"			78	95x1/6"	0,60	
	80	56	81	95		3"			92	110x1/4"	0,92	
	100	55	100	125		4"			120	130x1/4"	1,32	

КОНИЧЕСКИЙ ШТУЦЕР ПЕРЕХОДНОЙ	20380		РАЗМЕРЫ									
	DN	A	B	C	D	E	F	R	SW	резьб. DIN 405 Rd x s	кг	
	10	44	10	20,5		3/8"			19	28x1/8"	0,13	
	15	50	16	25		1/2"			24	34x1/8"	0,17	
	20	53	20	32		3/4"			30	44x1/6"	0,26	
	25	53	26	37		1"			35	52x1/6"	0,35	
	32	60	32	46		1 1/4"			44	58x1/6"	0,43	
	40	65	38	52,5		1 1/2"			51	65x1/6"	0,52	
	50	67	50	65,5		2"			63	78x1/6"	0,75	
	65	76	66	81		2 1/2"			78	95x1/6"	1,27	
	80	80	81	95		3"			92	110x1/4"	1,62	
	100	100	100	125		4"			120	130x1/4"	2,54	

ШТУЦЕР ЁЛОЧКА / ЁРШ РЕЗЬБОВОЙ	20510		РАЗМЕРЫ									
	DN	A	B	C	D	E	F	R	L	резьб. DIN 405 Rd x s	кг	
	10	60	10	12		7			10	28x1/8"	0,05	
	15	61	16	18,5		13			15	34x1/8"	0,08	
	20	65	20	23		16			20	44x1/6"	0,17	
	25	70	26	28		20			25	52x1/6"	0,23	
	32	84	32	35,6		27			32	58x1/6"	0,33	
	40	95	38	43,6		35			40	65x1/6"	0,52	
	50	110	50	53,6		45			50	78x1/6"	0,66	
	65	133	66	66,6		58			65	95x1/6"	1,14	
	80	145	81	83,6		75			80	110x1/4"	1,50	
	100	161	100	103,6		95			100	130x1/4"	2,40	

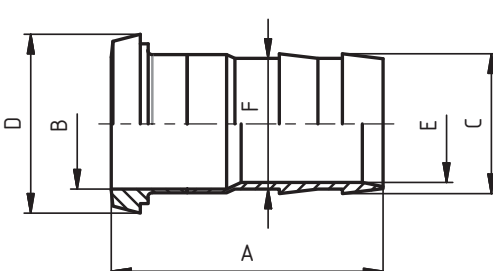
ШТУЦЕР ЁЛОЧКА / ЁРШ КОНИЧЕСКИЙ	20520		РАЗМЕРЫ									
	DN	A	B	C	D	E	F	R	L	резьб DIN 405 Rd x s	кг	
	10	60	10	12	22,5	7	10				0,04	
	15	61	16	18,5	28,5	13	15				0,06	
	20	65	20	23	36,5	16	20				0,13	
	25	70	26	28	44	20	25				0,19	
	32	77	32	35,6	50	27	32				0,27	
	40	88	38	43,6	56	35	40				0,42	
	50	103	50	53,6	68,5	45	50				0,58	
	65	125	66	66,6	86	58	65				1,08	
	80	137	81	83,6	100	75	80				1,32	
	100	151	100	103,6	121	95	100				2,13	

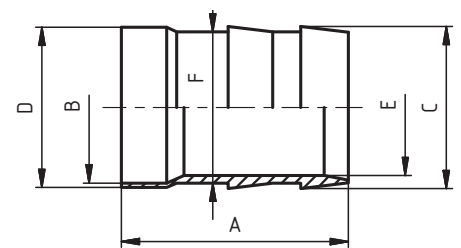
ШЛАНГОВАЯ НАДСТАВКА ПОД СВАРКУ / ЁРШ	20530		РАЗМЕРЫ									
	DN	A	B	C	D	E	F	R	L	резьб DIN 405 Rd x s	кг	
	10	43	10	12	13	7	10				0,02	
	15	44	16	18,5	19	13	15				0,04	
	20	47	20	23	23	16	20				0,06	
	25	48	26	28	29	20	25				0,06	
	32	52	32	35,6	35	27	32				0,08	
	40	62	38	43,6	41	35	40				0,12	
	50	75	50	53,6	53	45	50				0,22	
	65	93	66	66,6	70	58	65				0,58	
	80	100	81	83,6	85	75	80				0,68	
	100	107	100	103,6	104	95	100				1,72	

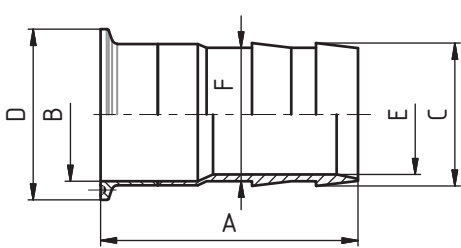
ШТУЦЕР КЛАМП / ЁРШ КЛАМП	20540		РАЗМЕРЫ									
	DN	A	B	C	D	E	F	R	L	резьб DIN 405 Rd x s	кг	
	10	61	10	12	34	7	10				0,05	
	15	62	16	18,5	34	13	15				0,08	
	20	65	20	23	34	16	20				0,17	
	25	69,5	26	28	50,5	20	25				0,23	
	32	73,5	32	35,6	50,5	27	32				0,33	
	40	83,5	38	43,6	50,5	35	40				0,52	
	50	96,5	50	53,6	64	45	50				0,66	
	65	121	66	66,6	91	58	65				1,14	
	80	128	81	83,6	106	75	80				1,50	
	100	135	100	103,6	119	95	100				2,40	

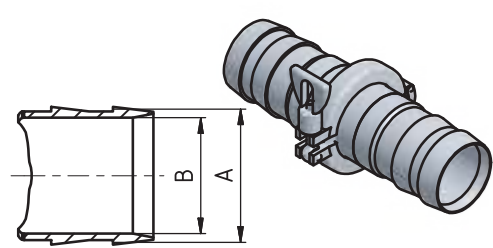
СОЕДИНЕНИЕ КЛАМП ДЛЯ ШЛАНГОВ	21300		РАЗМЕРЫ									
	DN	A	B	C	D	E	F	R	L	резьб DIN 405 Rd x s	кг	
	10	12	7								0,30	
	15	18,5	13								0,32	
	20	23	16								0,36	
	25	28	20								0,41	
	32	35,6	27								0,43	
	40	43,6	35								0,49	
	50	53,6	45								0,61	
	65	66,6	58								1,47	
	80	83,6	75								1,63	
	100	103,6	95								2,71	

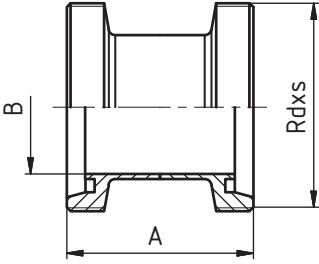
МУФТА РЕЗЬБА-РЕЗЬБА	20570		РАЗМЕРЫ									
	DN	A	B	C	D	E	F	R	L	резьб DIN 405 Rd x s	кг	
	10	42	10							28x1/8"	0,09	
	15	42	16							34x1/8"	0,11	
	20	48	20							44x1/6"	0,21	
	25	58	26							52x1/6"	0,28	
	32	64	32							58x1/6"	0,36	
	40	66	38							65x1/6"	0,46	
	50	70	50							78x1/6"	0,67	
	65	80	66							95x1/6"	1,06	
	80	90	81							110x1/4"	1,41	
	100	108	100							130x1/4"	2,13	

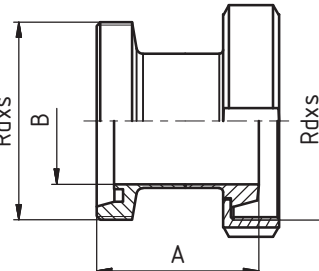
МУФТА ГАЙКА-РЕЗЬБА	20580		РАЗМЕРЫ									
	DN	A	B	C	D	E	F	R	L	резьб DIN 405 Rd x s	кг	
	10	42	10							28x1/8"	0,13	
	15	42	16							34x1/8"	0,16	
	20	48	20							44x1/6"	0,28	
	25	58	26							52x1/6"	0,39	
	32	64	32							58x1/6"	0,47	
	40	66	38							65x1/6"	0,55	
	50	70	50							78x1/6"	0,77	
	65	80	66							95x1/6"	1,24	
	80	90	81							110x1/4"	1,73	
	100	108	100							130x1/4"	2,40	

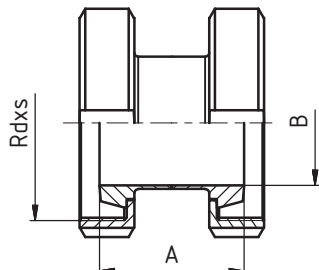
МУФТА ГАЙКА-ГАЙКА	20590		РАЗМЕРЫ									
	DN	A	B	C	D	E	F	R	L	резьб DIN 405 Rd x s	кг	
	10	34	10							28x1/8"	0,18	
	15	34	16							34x1/8"	0,22	
	20	36	20							44x1/6"	0,38	
	25	44	26							52x1/6"	0,54	
	32	50	32							58x1/6"	0,66	
	40	52	38							65x1/6"	0,76	
	50	56	50							78x1/6"	1,06	
	65	64	66							95x1/6"	1,72	
	80	74	81							110x1/4"	2,36	
	100	88	100							130x1/4"	3,38	

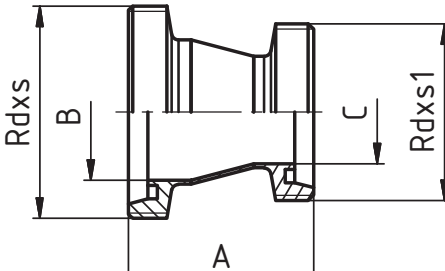
ПЕРЕХОДНИК РЕЗЬБА-РЕЗЬБА	20630		РАЗМЕРЫ									
	DN	A	B	C	D	E	резьб DIN 405 Rd x s	резьб DIN 405 Rd x s1	кг			
	32/25	55	32	26			58x1/6"	52x1/6"	0,36			
	40/25	66	38	25			65x1/6"	52x1/6"	0,40			
	40/32	55	38	32			65x1/6"	58x1/6"	0,46			
	50/32	78	50	32			78x1/6"	58x1/6"	0,61			
	50/40	68	50	38			78x1/6"	65x1/6"	0,67			
	65/40	98	66	38			95x1/6"	65x1/6"	1,00			
	65/50	77	66	50			95x1/6"	78x1/6"	1,06			
	80/50	104	81	50			110x1/4"	78x1/6"	1,37			
	80/65	77	81	66			110x1/4"	95x1/6"	1,41			
	100/65	116	100	66			130x1/4"	95x1/6"	2,08			
100/80	89	100	81			130x1/4"	110x1/4"	2,13				

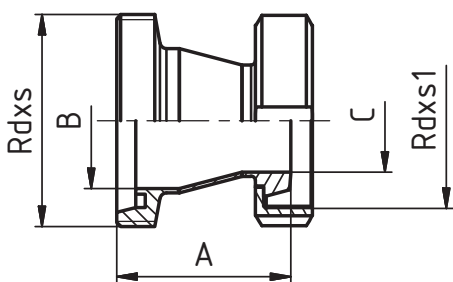
ПЕРЕХОДНИК РЕЗЬБА-ГАЙКА	20640		РАЗМЕРЫ							
	DN	A	B	C	D	E	резьб DIN 405 Rd x s	резьб DIN 405 Rd x s1	кг	
	32/25	51	32	26			58x1/6"	52x1/6"	0,47	
	40/25	62	38	26			65x1/6"	52x1/6"	0,50	
	40/32	59	38	32			65x1/6"	58x1/6"	0,55	
	50/32	74	50	32			78x1/6"	58x1/6"	0,71	
	50/40	64	50	38			78x1/6"	65x1/6"	0,77	
	65/40	94	66	38			95x1/6"	65x1/6"	1,19	
	65/50	73	66	50			95x1/6"	78x1/6"	1,24	
	80/50	100	81	50			110x1/4"	78x1/6"	1,68	
	80/65	73	81	66			110x1/4"	95x1/6"	1,73	
	100/65	112	100	66			130x1/4"	95x1/6"	2,35	
100/80	85	100	81			130x1/4"	110x1/4"	2,40		

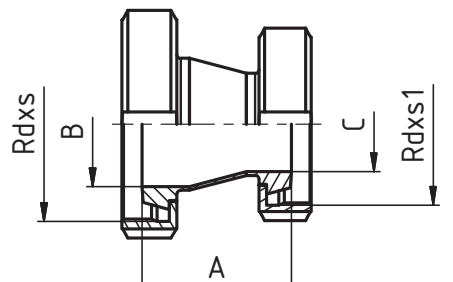
ПЕРЕХОДНИК ГАЙКА-ГАЙКА	20650		РАЗМЕРЫ							
	DN	A	B	C	D	E	резьб DIN 405 Rd x s	резьб DIN 405 Rd x s1	кг	
	32/25	47	32	26			58x1/6"	52x1/6"	0,66	
	40/25	58	38	26			65x1/6"	52x1/6"	0,71	
	40/32	47	38	32			65x1/6"	58x1/6"	0,76	
	50/32	70	50	32			78x1/6"	58x1/6"	1,01	
	50/40	60	50	38			78x1/6"	65x1/6"	1,06	
	65/40	90	66	38			95x1/6"	65x1/6"	1,67	
	65/50	69	66	50			95x1/6"	78x1/6"	1,72	
	80/50	96	81	50			110x1/4"	78x1/6"	2,30	
	80/65	69	81	66			110x1/4"	95x1/6"	2,36	
	100/65	107	100	66			130x1/4"	95x1/6"	3,32	
100/80	80	100	81			130x1/4"	110x1/4"	3,38		

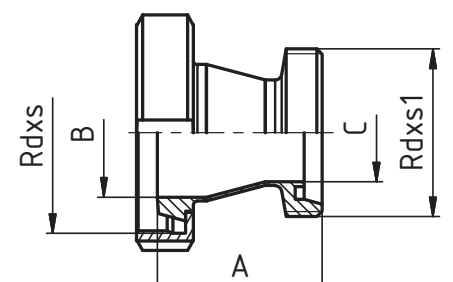
ПЕРЕХОДНИК ГАЙКА-РЕЗЬБА	20660		РАЗМЕРЫ							
	DN	A	B	C	D	E	резьб DIN 405 Rd x s	резьб DIN 405 Rd x s1	кг	
	32/25	51	32	26			58x1/6"	52x1/6"	0,47	
	40/25	62	38	25			65x1/6"	52x1/6"	0,50	
	40/32	59	38	32			65x1/6"	58x1/6"	0,55	
	50/32	74	50	32			78x1/6"	58x1/6"	0,71	
	50/40	64	50	38			78x1/6"	65x1/6"	0,77	
	65/40	94	66	38			95x1/6"	65x1/6"	1,19	
	65/50	73	66	50			95x1/6"	78x1/6"	1,24	
	80/50	100	81	50			110x1/4"	78x1/6"	1,68	
	80/65	73	81	66			110x1/4"	95x1/6"	1,73	
	100/65	112	100	66			130x1/4"	95x1/6"	2,35	
100/80	85	100	81			130x1/4"	110x1/4"	2,40		

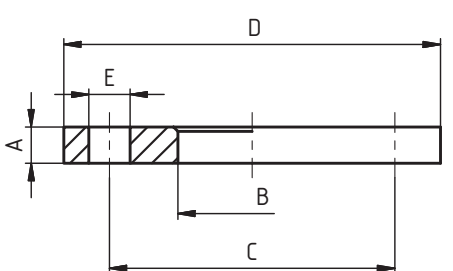
ФЛАНЕЦ AL	20780 AL		РАЗМЕРЫ								
	DN	A	B	C	D	E	F	R	L	резьб DIN 405 Rd x s	кг
	10	14	19	60	90	14x4					0,59
	15	14	24	65	95	14x4					0,68
	20	16	24	75	105	14x4					0,80
	25	16	36	85	115	14x4					1,11
	32	16	46	100	140	18x4					1,64
	40	16	54	110	150	18x4					1,86
	50	16	65	125	165	18x4					2,20
	65	16	81	145	185	18x4					2,62
	80	18	94	160	200	18x8					3,32
	100	18	119	180	220	18x8					3,67
125	18	145	210	250	18x8					4,54	
150	18	173	240	285	22x8					5,60	

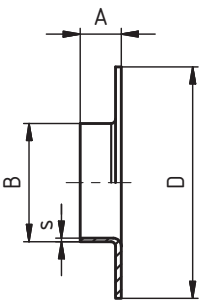
ОТБОРТОВКА DIN	20790 DIN		РАЗМЕРЫ								резьб DIN 405 Rd x s	кг
	DN	A	B	C	D	E	F	R	s			
	10	6	12		40					1,5		
	15	8	18		45					1,5		
	20	10	23		58					1,5		
	25	10	28		68					1,5		
	32	12	35		78					1,5		
	40	15	40		88					1,5		
	50	18	52		102					1,5		
	65	25	70		122					2,0		
	80	25	85		138					2,0		
	100	25	104		158					2,0		
	125	28	129		188					2,0		
	150	28	154		212					2,0		

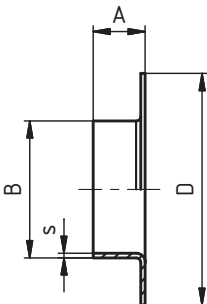
ОТБОРТОВКА ISO	20790 ISO		РАЗМЕРЫ								резьб DIN 405 Rd x s	кг
	DN	A	B	C	D	E	F	R	s			
	10	9	17,2		40					2		
	15	9	21,3		45					2		
	20	12	26,9		58					2		
	25	15	33,7		68					2		
	32	15	42,4		78					2		
	40	17	48,3		88					2		
	50	23	60,3		102					2		
	65	23	76,1		122					2		
	80	23	88,9		138					3		
	100	28	114,3		158					3		
	125	30	139,7		188					3		
	150	30	168,3		212					3		

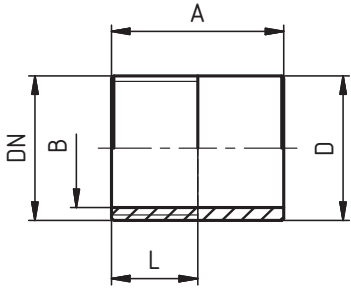
ПОЛУСГОН НР-СВ	20800		РАЗМЕРЫ								резьб DIN 405 Rd x s	кг
	DN	A	B	C	D	E	F	R	L			
	1/8"	30	7		10,5					10		0,02
	1/4"	30	9,3		13,6					11		0,02
	3/8"	30	13		17,1					10,5		0,03
	1/2"	35	16		21,5					15,5		0,04
	3/4"	40	21,6		27					16,5		0,06
	1"	40	27,5		33,6					20		0,10
	1 1/4"	50	36,6		42,2					20		0,15
	1 1/2"	50	41,5		48,5					22,5		0,16
	2"	50	53,6		60,6					25,5		0,22
	2 1/2"	60	68,9		76,1					30		0,42
	3"	70	81,5		89,4					34		0,68
	4"	80	105,8		114,3					39		0,97

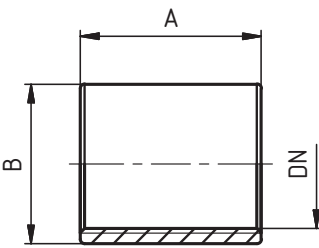
МУФТА ВР-ВР	20840		РАЗМЕРЫ								резьб DIN 405 Rd x s	кг
	DN	A	B	C	D	E	F	R	L			
	1/8"	15	15									0,02
	1/4"	25	18									0,02
	3/8"	26	20,5									0,03
	1/2"	33	25									0,08
	3/4"	35	32									0,11
	1"	42	37									0,17
	1 1/4"	45	46									0,32
	1 1/2"	45	52,5									0,40
	2"	55	65,5									0,48
	2 1/2"	63	81									1,20
	3"	69	95									1,57
	4"	80	114,6									2,40

ФЛАНЦЕВОЕ СОЕДИНЕНИЕ ПН 10	20720	ОПИСАНИЕ
	DIN 2576	
		
<p>Фланцевое соединение ПН 10</p> <ul style="list-style-type: none"> – Простой монтаж – Легкая замена уплотнения <p>Размеры: DN 10 – DN 150</p> <p>Материал: 1.4301 (AISI 304) 1.4404 (AISI 316L)</p> <p>Уплотнение: NBR (стандартное) EPDM Viton</p>		

КОМПЛЕКТУЮЩИЕ



Деталь уплотнения

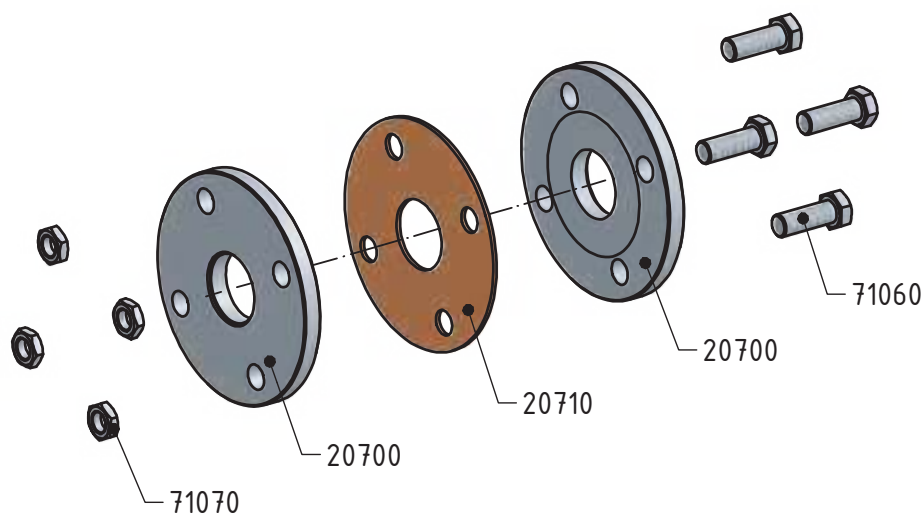

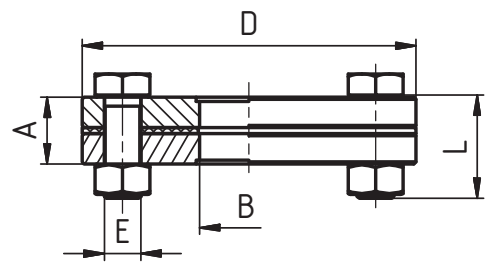
ФЛАНЦЕВОЕ СОЕДИНЕНИЕ ПН 10 - КОМПЛЕКТ	20720	РАЗМЕРЫ										
	DIN 2576	DN	A	B	C	D	E	F	R	L	резьб. DIN 405 Rd x s	кг
		10	31	10		90	4xM14			40		1,30
		15	31	16		95	4xM14			40		1,40
		20	31	20		105	4xM14			45		2,00
		25	31	26		115	4xM14			45		2,30
		32	31	32		140	4xM18			50		3,50
		40	31	38		150	4xM18			50		4,00
		50	31	50		165	4xM18			55		5,10
		65	32	66		185	4xM18			55		6,00
		80	36	81		200	8xM18			55		7,50
		100	36	100		220	8xM18			55		8,30
		125	44	125		250	8xM18			60		13,00
	150	52	150		285	8xM22			65		16,70	

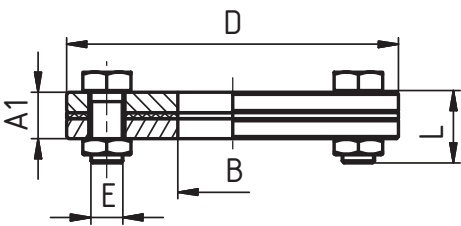
ФЛАНЦЕВОЕ СОЕДИНЕНИЕ ПН 10 ECO – КОМПЛЕКТ	20720 ECO	РАЗМЕРЫ										
	DIN 2576	DN	A1	B	C	D	E	F	R	L	резьб DIN 405 Rd x s	кг
		10	23	17,7		90	4xM14			35		1,20
		15	23	18,6		95	4xM14			35		1,30
		20	23	26		105	4xM14			35		1,60
		25	23	31		115	4xM14			35		1,80
		32	23	39		140	4xM18			40		2,80
		40	23	45,5		150	4xM18			40		3,10
		50	23	54,5		165	4xM18			40		3,80
		65	24	71		185	4xM18			40		4,20
		80	24	85		200	8xM18			40		4,80
		100	24	105,5		220	8xM18			40		5,30
		125	28	130,5		250	8xM18			45		8,30
		150	28	155,5		285	8xM22			50		11,00

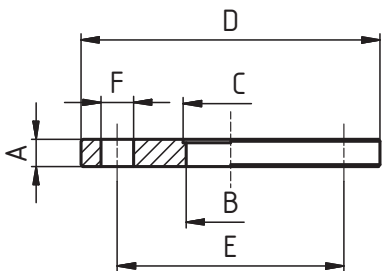
ФЛАНЕЦ ПЛОСКИЙ ПН 10	20700	РАЗМЕРЫ										
	DIN 2576	DN	A	B	C	D	E	F	R	L	резьб DIN 405 Rd x s	кг
		10	14	10	12,2	90	60	14x4				0,50
		15	14	16	18,2	95	65	14x4				0,60
		20	14	20	22,2	105	75	14x4				0,85
		25	14	26	28,2	115	85	14x4				1,11
		32	14	32	34,2	140	100	18x4				1,64
		40	14	38	40,2	150	110	18x4				1,80
		50	14	50	52,2	165	125	18x4				2,30
		65	14	66	70,3	185	145	18x4				2,88
		80	16	81	85,3	200	160	18x8				3,20
		100	16	100	104,3	220	180	18x8				4,00
		125	20	125	129,5	250	210	18x8				5,00
		150	24	150	154,5	285	240	22x8				6,70

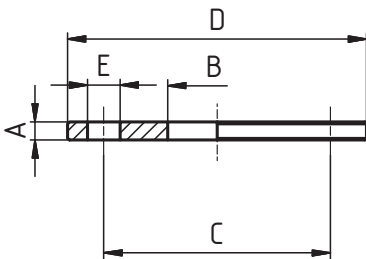
ФЛАНЕЦ ПЛОСКИЙ ПН 10 ECO	20700 ECO	РАЗМЕРЫ										
	DIN 2576	DN	A	B	C	D	E	F	R	L	резьб DIN 405 Rd x s	кг
		25	10	29	85	115	14x4					0,69
		32	10	35	100	140	18x4					1,00
		40	10	41,5	110	150	18x4					1,16
		50	10	52,8	125	165	18x4					1,23
		65	10	71,2	145	185	18x4					1,68
		80	10	86,5	160	200	18x8					1,62
		100	10	105,5	180	220	18x8					1,89
		125	12	131	210	250	18x8					3,33
		150	12	155,5	240	285	22x8					4,12

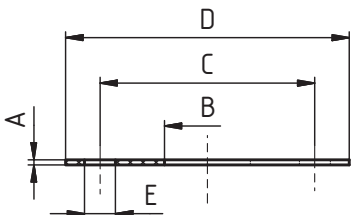
УПЛОТНЕНИЕ ДЛЯ ФЛАНЦА ПН 10	20710	РАЗМЕРЫ										
	DIN 2576	DN	A	B	C	D	E	F	R	L	резьб DIN 405 Rd x s	кг
		10	3	10	60	90	14x4					
		15	3	16	65	95	14x4					
		20	3	20	75	105	14x4					
		25	3	26	85	115	14x4					
		32	3	32	100	140	18x4					
		40	3	38	110	150	18x4					
		50	3	50	125	165	18x4					
		65	4	66	145	185	18x4					
		80	4	81	160	200	18x8					
		100	4	100	180	220	18x8					
		125	4	125	210	250	18x8					
		150	4	150	240	285	22x8					

ФЛАНЦЕВОЕ СОЕДИНЕНИЕ ВОРОТНИКОВОЕ ПН 16	20740	ОПИСАНИЕ
	DIN 2633	
		Фл анцевое соединение ПН 16 DIN 2633 – Простой монтаж – Легкая замена уплотнения
		Размеры: DN 10 - DN 150 Материал: 1.4301 (AISI 304) 1.4404 (AISI 316L) Уплотнение: NBR (стандартное) EPDM Viton

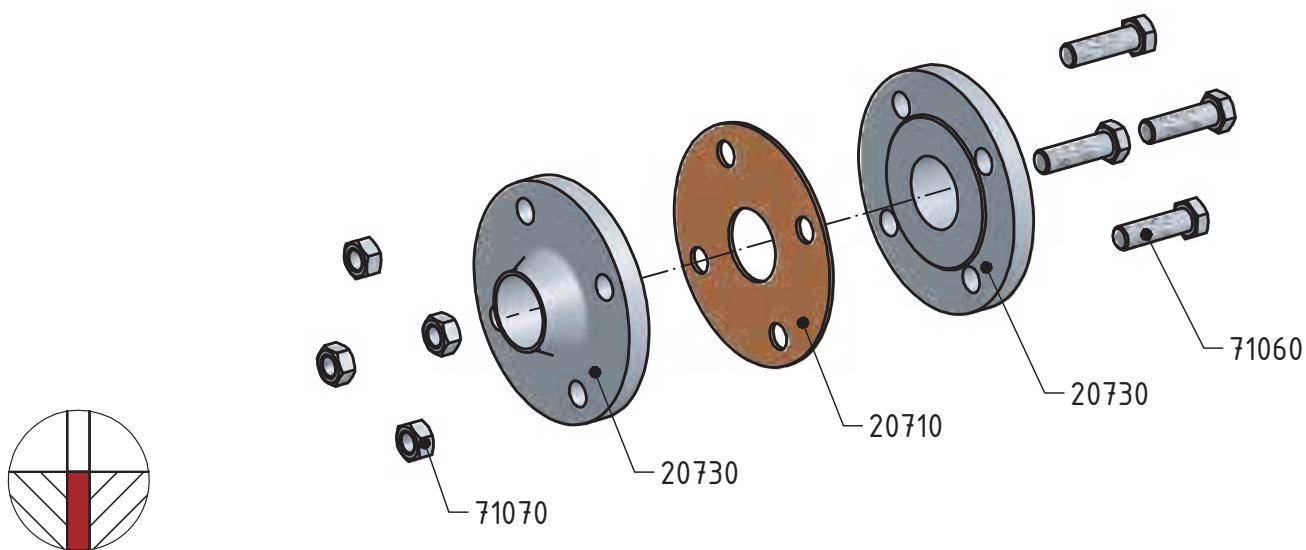
КОМПЛЕКТУЮЩИЕ

Деталь уплотнения

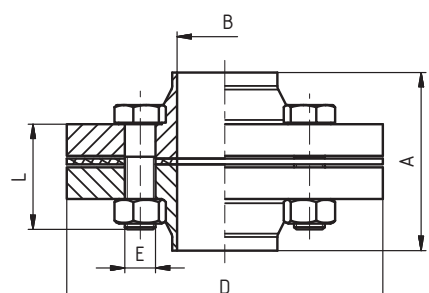
ФЛАНЦЕВОЕ СОЕДИНЕНИЕ ВОРОТНИКОВОЕ ПН 16 - КОМПЛЕКТ	20740	РАЗМЕРЫ										
	DIN 2633	DN	A	B	C	D	E	F	R	L	резьб. DIN 405 Rd x s	кг
	10	73	10			90	4xM14			45		1,16
	15	73	16			95	4xM14			45		1,30
	20	79	20			105	4xM14			45		1,90
	25	79	26			115	4xM14			50		2,28
	32	83	32			140	4xM18			50		3,20
	40	88	38			150	4xM18			50		3,60
	50	94	50			165	4xM18			55		5,06
	65	94	66			185	4xM18			55		6,12
	80	104	81			200	8xM18			60		7,40
	100	108	100			220	8xM18			60		9,24
125	114	125			250	8xM18			65		12,60	
150	114	150			285	8xM22			70		15,5	

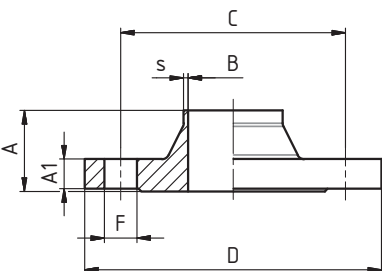
ФЛАНЕЦ ВОРОТНИКОВЫЙ ПН 16	20730	РАЗМЕРЫ										
	DIN 2633	DN	A	A1	B	C	D	F	R	s	резьб DIN 405 Rd x s	кг
		10	35	14	10	60	90	14x4		1,5		0,58
		15	35	14	16	65	95	14x4		1,5		0,65
		20	38	16	20	75	105	14x4		1,5		0,95
		25	38	16	26	85	115	14x4		1,5		1,14
		32	40	16	32	100	140	18x4		1,5		1,60
		40	42	16	38	110	150	18x4		1,5		1,80
		50	45	18	50	125	165	18x4		1,5		2,53
		65	45	18	66	145	185	18x4		2		3,06
		80	50	20	81	160	200	18x8		2		3,70
		100	52	20	100	180	220	18x8		2		4,62
		125	55	22	125	210	250	18x8		2		6,30
		150	55	22	150	240	285	22x8		2		7,75

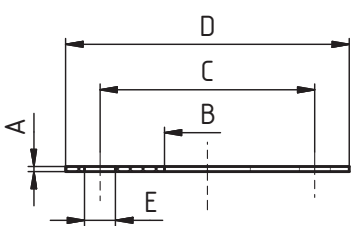
УПЛОТНЕНИЕ ДЛЯ ФЛАНЦА ПН 16	20710	РАЗМЕРЫ										
	DIN 2633	DN	A	B	C	D	E	F	R	L	резьб DIN 405 Rd x s	кг
		10	3	10	60	90	14x4					
		15	3	16	65	95	14x4					
		20	3	20	75	105	14x4					
		25	3	26	85	115	14x4					
		32	3	32	100	140	18x4					
		40	3	38	110	150	18x4					
		50	3	50	125	165	18x4					
		65	4	66	145	185	18x4					
		80	4	81	160	200	18x8					
		100	4	100	180	220	18x8					
		125	4	125	210	250	18x8					
		150	4	150	240	285	22x8					

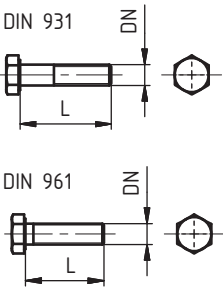
БОЛТ НЕРЖАВЕЮЩИЙ - ШЕСТИГРАННЫЙ УГОЛ	71060	РАЗМЕРЫ										
	DIN 931, 961	DN	A	L							резьб DIN 405 Rd x s	кг
		M8		30, 35, 40, 45, 50, 55, 60, 65, 70, 80, 90, 100								
		M10		30, 35, 40, 45, 50, 55, 60, 65, 70, 80, 90, 100								
		M12		30, 35, 40, 45, 50, 55, 60, 65, 70, 80, 90, 100								
		M14		30, 35, 40, 45, 50, 55, 60, 65, 70, 80, 90, 100								
		M16		30, 35, 40, 45, 50, 55, 60, 65, 70, 80, 90, 100								
		M18		30, 35, 40, 45, 50, 55, 60, 65, 70, 80, 90, 100								
		M22		30, 35, 40, 45, 50, 55, 60, 65, 70, 80, 90, 100								

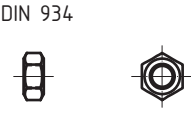
ГАЙКА НЕРЖАВЕЮЩАЯ	71070	РАЗМЕРЫ										
	DIN 934	DN	A	B	C	D	E	F	R	L	резьб DIN 405 Rd x s	кг
		M8										
		M10										
		M12										
		M14										
		M16										
		M18										
		M22										

ФЛАНЦЕВОЕ СОЕДИНЕНИЕ С ОТБОРТОВКОЙ ПН 10	20420	ОПИСАНИЕ
		<p>Фланцевое соединение ПН 10</p> <ul style="list-style-type: none"> – Простой монтаж – Легкая замена уплотнения <p>Размеры: DN 10 – DN 150</p> <p>Материал: 1.4301 (AISI 304) 1.4404 (AISI 316L)</p> <p>Уплотнение: NBR (стандартное) EPDM Viton</p>

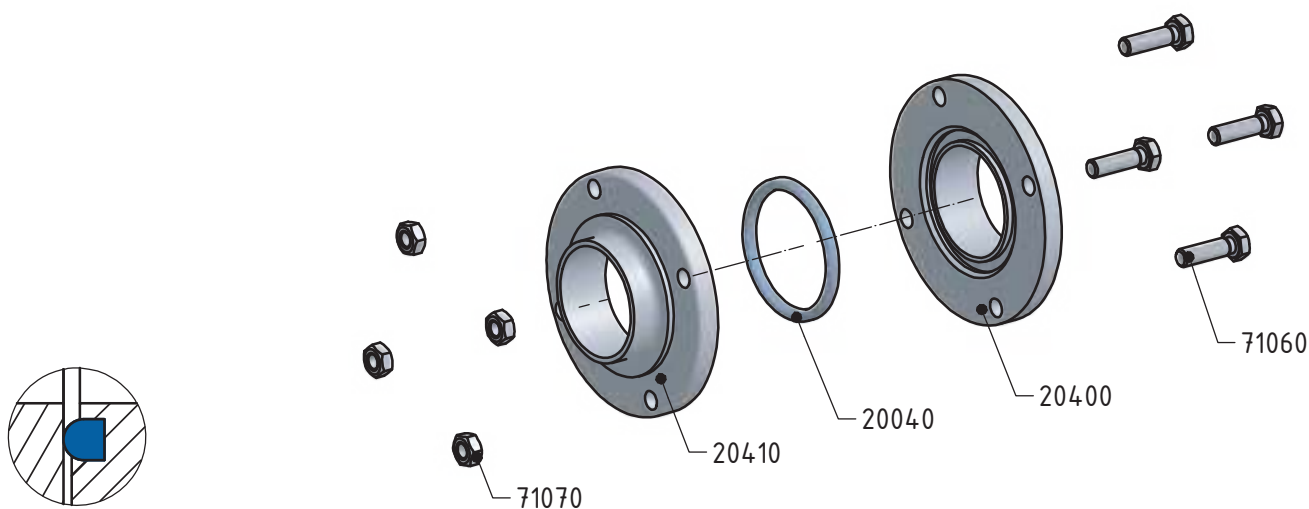
КОМПЛЕКТУЮЩИЕ

Деталь уплотнения

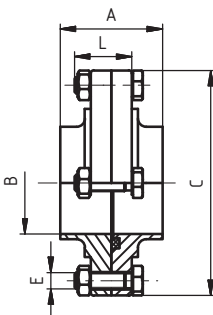
ФЛАНЦЕВОЕ СОЕДИНЕНИЕ ПН 10 – КОМПЛЕКТ	20420	РАЗМЕРЫ										
		DN	A	B	C	D	E	F	R	L	резьб. DIN 405 Rd x s	кг
		10	40	10	62		4xM8			25		0,40
		15	40	16	68		4xM8			25		0,52
		20	40	20	75		4xM8			30		0,58
		25	40	26	87		4xM8			30		0,78
		32	40	32	92		4xM8			30		0,92
		40	50	38	97		4xM8			30		0,94
		50	50	50	110		4xM8			30		1,18
		65	50	66	127		4xM8			30		1,50
		80	60	81	142		4xM8			30		2,56
		100	60	100	162		4xM8			30		3,44
		125	80	125	200		6xM10			40		5,74
		150	90	150	230		6xM10			40		7,70

ФЛАНЦЕВОЕ СОЕДИНЕНИЕ ПН 10 ГИГИЕНИЧЕСКОЕ	22870	ОПИСАНИЕ
	DIN 11 853	
		<p>Фланцевое соединение ПН 10 гигиеническое DIN 11853</p> <ul style="list-style-type: none"> – Простой монтаж – Легкая замена уплотнения <p>Размеры: DN 10 – DN 150</p> <p>Материал: 1.4301 (AISI 304) 1.4404 (AISI 316L)</p> <p>Уплотнение: EPDM (стандартное) Viton</p>

КОМПЛЕКТУЮЩИЕ

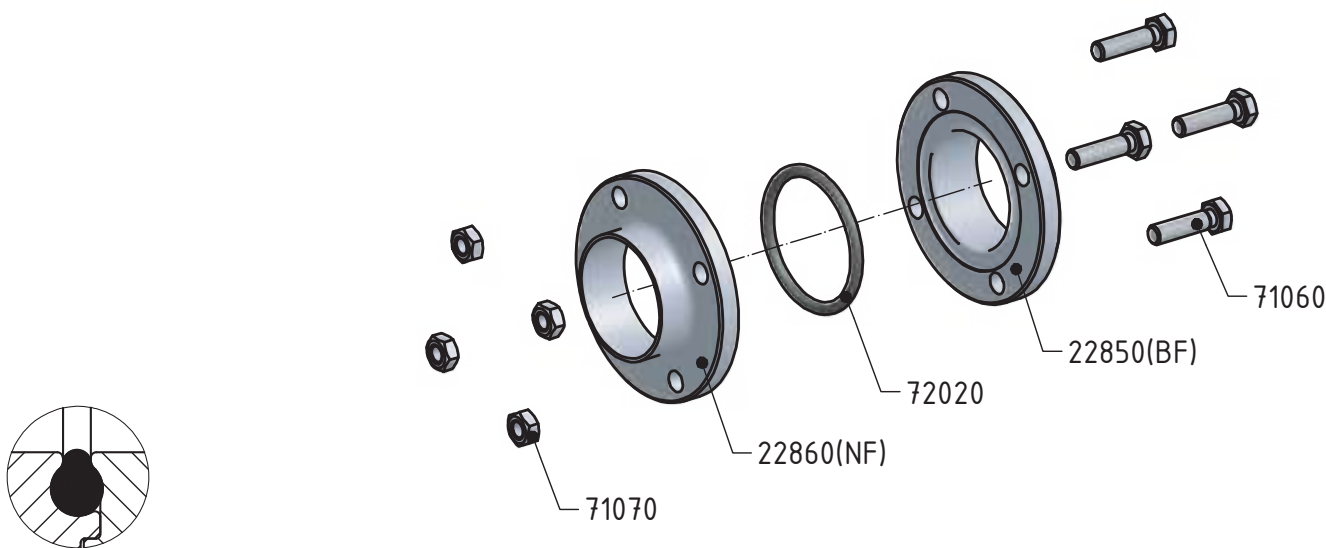

Деталь уплотнения

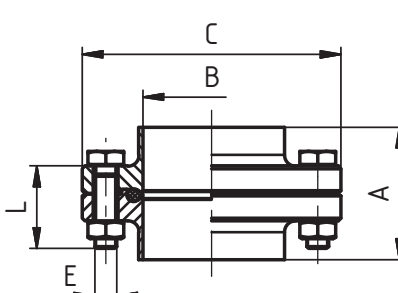
ФЛАНЦЕВОЕ СОЕДИНЕНИЕ ПН 10 - КОМПЛЕКТ	22870	РАЗМЕРЫ										
	DIN 11 853	DN	A	B	C	D	E	F	R	L	резьб. DIN 405 Rd x s	кг
	10	48	10	54		4xM8				25		0,41
	15	48	16	59		4xM8				25		0,46
	20	48	20	64		4xM8				25		0,52
	25	48	26	70		4xM8				25		0,60
	32	48	32	76		4xM8				25		0,66
	40	48	38	82		4xM8				25		0,73
	50	48	50	94		4xM8				25		0,87
	65	48	66	113		8xM8				25		1,21
	80	52	81	133		8xM10				30		1,96
	100	52	100	159		8xM10				35		2,97
125	56	125	183		8xM10				35		3,47	
150	56	150	213		8xM12				40		5,02	

ФЛАНЦЕВОЕ СОЕДИНЕНИЕ ПН 10 АСЕПТИЧЕСКОЕ	22930	ОПИСАНИЕ
	DIN 11 864-2-A	
		Фл анцевое соединение ПН 10 септическое DIN 11864 – Простой монтаж – Легкая замена уплотнения Размеры: DN 10 – DN 150 Материал: 1.4301 (AISI 304) 1.4404 (AISI 316L) Уплотнение: EPDM (стандартное) Viton

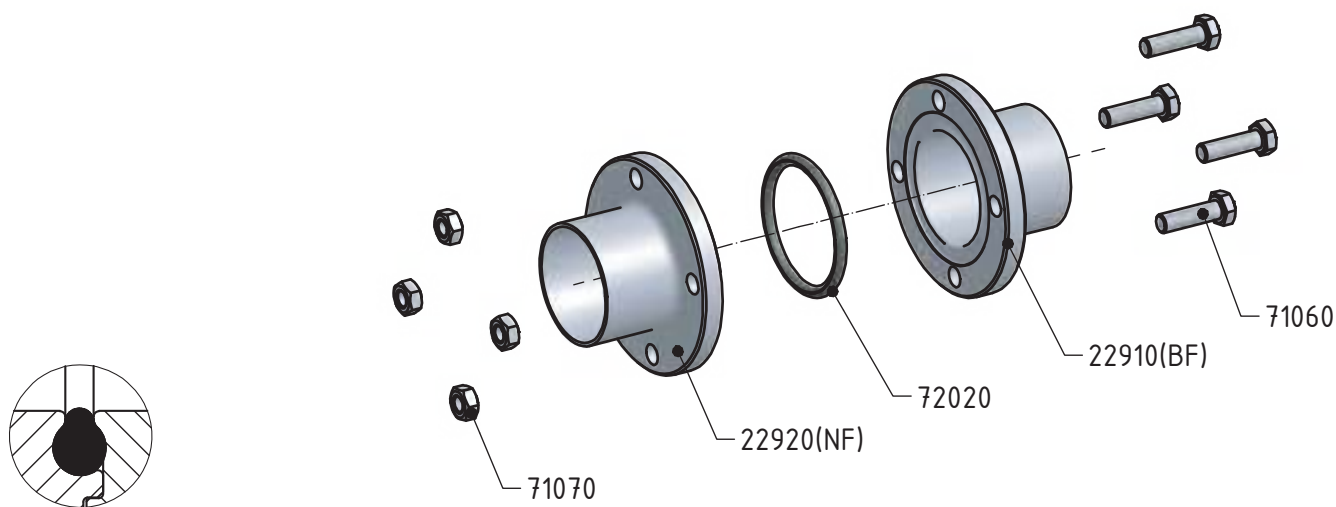
КОМПЛЕКТУЮЩИЕ

Деталь уплотнения

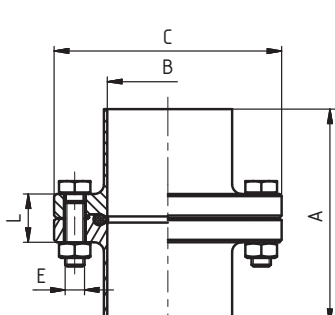
ФЛАНЦЕВОЕ СОЕДИНЕНИЕ ПН 10 – КОМПЛЕКТ	22930	РАЗМЕРЫ										
	DIN 11 864-2-A	DN	A	B	C	D	E	F	R	L	резьба DIN 405 Rd x s	кг
	10	80	10	54		4xM8				25		
	15	80	16	59		4xM8				25		
	20	80	20	64		4xM8				25		
	25	80	26	70		4xM8				25		
	32	90	32	76		4xM8				25		
	40	90	38	82		4xM8				25		
	50	90	50	94		4xM8				25		
	65	108	66	113		8xM8				25		
	80	116	81	133		8xM10				30		
	100	116	100	159		8xM10				35		
125	120	125	183		8xM10				35			
150	120	150	213		8xM12				40			

СОЕДИНЕНИЕ КЛАМП, DIN 11864-3	22970	ОПИСАНИЕ
	DIN 11864-3	
		<p>Соединение Кламп DIN 11864-3</p> <ul style="list-style-type: none"> – Простой монтаж – Легкая замена уплотнения <p>Размеры: DN 10 - DN 100</p> <p>Материал: 1.4404 (AISI 316L)</p> <p>Уплотнение: Silikon, EPDM, PTFE – Viton (стандартные)</p>

КОМПЛЕКТУЮЩИЕ



Деталь уплотнения

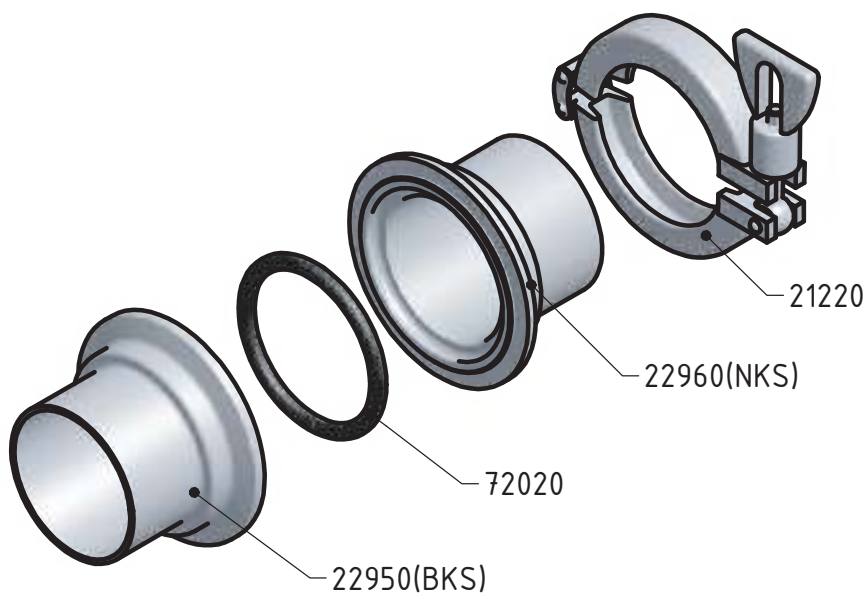

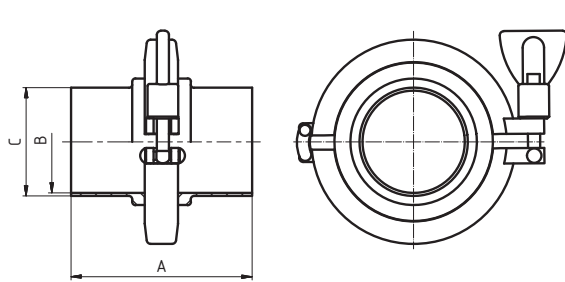
СОЕДИНЕНИЕ КЛАМП, DIN 11864-3	22970	РАЗМЕРЫ										
	DIN 11864-3	DN	A	B	C	D	E	F	R	L	резьб. DIN 405 Rd x s	кг
	10	77,5	10	13								
	15	77,5	16	19								
	20	77,5	20	23								
	25	78,5	26	29								
	32	89,5	32	35								
	40	89,5	38	41								
	50	90,5	50	53								
	65	114,5	66	70								
	80	118,5	81	85								
	100	121,5	100	104								

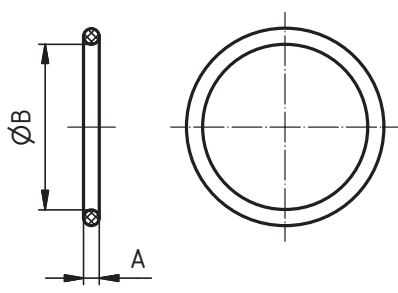
УПЛОТНЕНИЕ	72020		РАЗМЕРЫ									
	DN	A	B	C	D	E	F	R	L	резьб DIN 405 Rd x s	кг	
	10	3,5	12								0,0012	
	15	3,5	18								0,0016	
	20	3,5	22								0,0026	
	25	3,5	28								0,0036	
	32	5	34								0,0040	
	40	5	40								0,0048	
	50	5	52								0,0062	
	65	5	68								0,0070	
	80	5	83								0,0080	
	100	5	102								0,0134	
	125	5	127								0,0236	
	150	5	152								0,0276	

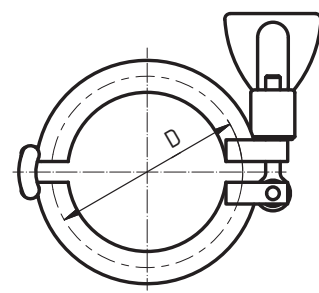
ХОМУТ КЛАМП	21220		РАЗМЕРЫ							
	DIN 11864-3	DN	SMS	DIN	D	DN	SMS	DIN	D	
		1/2"-3/4"	12,7	-	25	80	-	80	106	
		1/2"-3/4"	19,05	-	25	4"	101,6	100	119	
		10-20	-	10-20	34	125	-	125	155	
		1"-1 1/2"	25	25	50,5	6"	-	-	166,8	
		1"-1 1/2"	-	32	50,5	150	-	150	183	
		1"-1 1/2"	38	40	50,5	8"	-	-	217,6	
		2"	51	50	64	200	-	200	233,5	
		2 1/2"	63,5	-	77,5	250	-	250	268	
		3"	76,1	65	91	300	-	300	318,5	

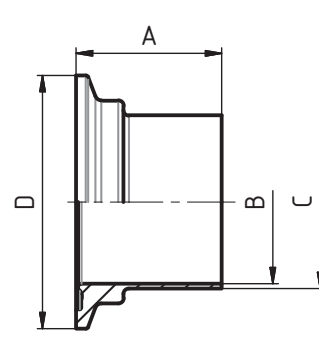
ПАТРУБОК КЛАМП (BKS)	22950 (BKS)		РАЗМЕРЫ									
	DN	A	B	C	D	E	F	R	L	резьб DIN 405 Rd x s	кг	
	10	38	10	13	34							
	15	38	16	19	34							
	20	38	20	23	50,5							
	25	38,5	26	29	50,5							
	32	44	32	35	50,5							
	40	44	38	41	64							
	50	44,5	50	53	77,5							
	65	56,5	66	70	91							
	80	58,5	81	85	106							
	100	60	100	104	130							

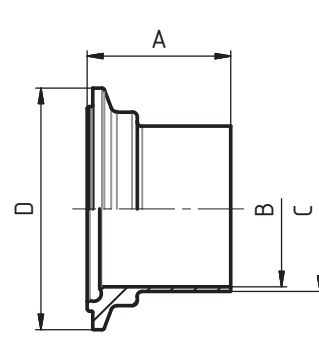
ПАТРУБОК КЛАМП (NKS)	22960 (NKS)		РАЗМЕРЫ									
	DN	A	B	C	D	E	F	R	L	резьб DIN 405 Rd x s	кг	
	10	39,5	10	13	34							
	15	39,5	16	19	34							
	20	39,5	20	23	50,5							
	25	40	26	29	50,5							
	32	45,5	32	35	50,5							
	40	45,5	38	41	64							
	50	46	50	53	77,5							
	65	58	66	70	91							
	80	60	81	85	106							
	100	61,5	100	104	130							



2

ФИТИНГИ

Отводы
Тройники
Переходники

ОТВОД 90° СВАРКА-СВАРКА	30010	РАЗМЕРЫ									
		DN	D	A	C	r					кг
	10	12	26	1,5	26						0,02
	10	13	26	1,5	26						0,02
	15	18	35	1,5	35						0,04
	15	19	35	1,5	35						0,04
	20	22	40	1,5	40						0,04
	20	23	40	1,5	40						0,08
	25	28	50	1,5	50						0,08
	25	29	50	1,5	50						0,08
	32	34	55	1,5	55						0,10
	32	35	55	1,5	55						0,10
	40	40	60	1,5	60						0,20
	40	41	60	1,5	60						0,20
	50	52	70	1,5	70						0,20
	50	53	70	1,5	70						0,20
	65	70	80	2,0	80						0,40
	80	85	90	2,0	90						0,56
	100	104	100	2,0	100						0,76
	125	129	187,5	2,0	187,5						1,64
	150	154	225	2,0	225						2,60

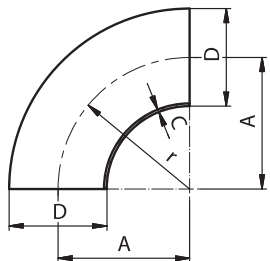

ОТВОД 90° УДЛИНЕННЫЙ СВАРКА-СВАРКА	30020	РАЗМЕРЫ									
		DN	D	A	C	r					кг
	10	12	38	1,5	26						0,02
	10	13	38	1,5	26						0,02
	15	18	47	1,5	35						0,04
	15	19	47	1,5	35						0,04
	20	22	52	1,5	40						0,06
	20	23	52	1,5	40						0,06
	25	28	70	1,5	50						0,12
	25	29	70	1,5	50						0,12
	32	34	78	1,5	52						0,16
	32	35	78	1,5	52						0,16
	40	40	90	1,5	60						0,20
	40	41	90	1,5	60						0,20
	50	52	100	1,5	72						0,28
	50	53	100	1,5	72						0,28
	65	70	110	2,0	85						0,56
	80	85	130	2,0	93						0,78
	100	104	150	2,0	110						1,10

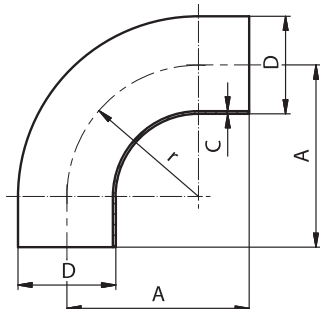

ОТВОД 90° ОСНАЩЕННЫЙ РЕЗЬБА-СВАРКА	30040	РАЗМЕРЫ										
		DN	A	B	C	D	E	F	R	L	Rd x s	кг
	10	26	10	1,5	13	43					28x1/8	0,06
	15	35	16	1,5	19	52					34x1/8	0,08
	20	40	20	1,5	23	59					44x1/6	0,12
	25	50	26	1,5	29	72					52x1/6	0,18
	32	55	32	1,5	35	77					58x1/6	0,22
	40	60	38	1,5	41	82					65x1/6	0,36
	50	70	50	1,5	53	93					78x1/6	0,42
	65	80	66	2,0	70	105					95x1/6	0,74
	80	90	81	2,0	85	116					110x1/4	1,06
	100	100	100	2,0	104	130					130x1/4	1,50
	125	187,5	125	2,0	129	223					160x1/4	1,75
	150	225	150	2,0	154	265					190x1/4	2,01

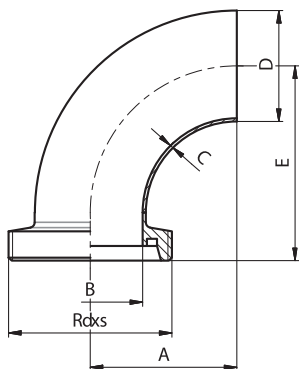

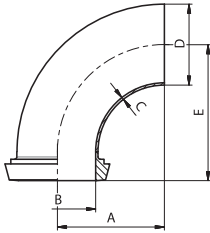
ОТВОД 90° ОСНАЩЕННЫЙ ШТУЦЕР КОНИЧЕСКИЙ-СВАРКА	30050		РАЗМЕРЫ									
	DN	A	B	C	D	E	F	R	L	Rd x s	кг	
	10	26	10	1,5	13	40					0,04	
	15	35	16	1,5	19	49					0,06	
	20	40	20	1,5	23	56					0,10	
	25	50	26	1,5	29	68					0,16	
	32	55	32	1,5	35	73					0,20	
	40	60	38	1,5	41	78					0,34	
	50	70	50	1,5	53	89					0,40	
	65	80	66	2,0	70	101					0,72	
	80	90	81	2,0	85	111					1,04	
	100	100	100	2,0	104	125					1,48	
	125	187,5	125	2,0	129	214,5					1,73	
	150	225	150	2,0	154	254					1,89	

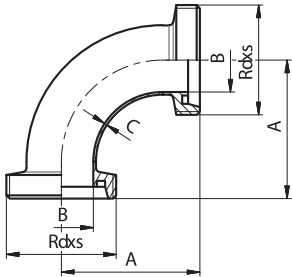
ОТВОД 90° ОСНАЩЕННЫЙ РЕЗЬБА-РЕЗЬБА	30060		РАЗМЕРЫ									
	DN	A	B	C	D	E	F	R	L	Rd x s	кг	
	10	43	10	1,5						28x1/8	0,10	
	15	52	16	1,5						34x1/8	0,15	
	20	59	20	1,5						44x1/6	0,26	
	25	72	26	1,5						52x1/6	0,35	
	32	77	32	1,5						58x1/6	0,41	
	40	82	38	1,5						65x1/6	0,51	
	50	93	50	1,5						78x1/6	0,72	
	65	105	66	2,0						95x1/6	1,06	
	80	116	81	2,0						110x1/4	1,73	
	100	130	100	2,0						130x1/4	2,18	
	125	223	125	2,0						160x1/4	4,21	
	150	265	150	2,0						190x1/4	6,66	

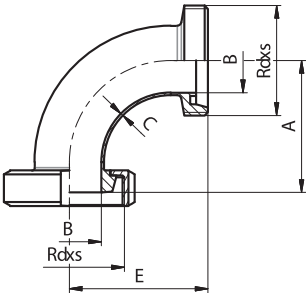
ОТВОД 90° ОСНАЩЕННЫЙ ГАЙКА-РЕЗЬБА	30070		РАЗМЕРЫ									
	DN	A	B	C	D	E	F	R	L	Rd x s	кг	
	10	40	10	1,5		43				28x1/8	0,16	
	15	49	16	1,5		52				34x1/8	0,21	
	20	56	20	1,5		59				44x1/6	0,34	
	25	68	26	1,5		72				52x1/6	0,47	
	32	73	32	1,5		77				58x1/6	0,57	
	40	78	38	1,5		82				65x1/6	0,70	
	50	89	50	1,5		93				78x1/6	0,97	
	65	101	66	2,0		105				95x1/6	1,52	
	80	111	81	2,0		115				110x1/4	2,23	
	100	125	100	2,0		130				130x1/4	3,01	
	125	214,5	125	2,0		223				160x1/4	4,21	
	150	254	150	2,0		265				190x1/4	8,01	

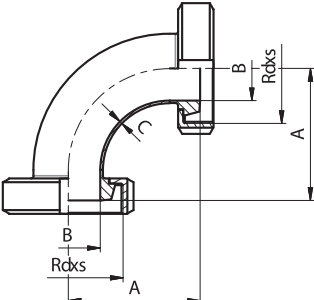
ОТВОД 90° ОСНАЩЕННЫЙ ГАЙКА-ГАЙКА	30080		РАЗМЕРЫ									
	DN	A	B	C	D	E	F	R	L	Rd x s	кг	
	10	40	10	1,5						28x1/8	0,21	
	15	49	16	1,5						34x1/8	0,27	
	20	56	20	1,5						44x1/6	0,42	
	25	68	26	1,5						52x1/6	0,63	
	32	73	32	1,5						58x1/6	0,73	
	40	78	38	1,5						65x1/6	0,87	
	50	89	50	1,5						78x1/6	1,23	
	65	101	66	2,0						95x1/6	1,99	
	80	111	81	2,0						110x1/4	2,73	
	100	125	100	2,0						130x1/4	3,84	
	125	214,5	125	2,0						160x1/4	6,37	
	150	254	150	2,0						190x1/4	9,36	

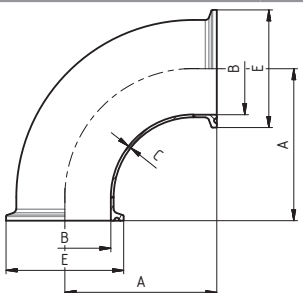
ОТВОД 90° ОСНАЩЕННЫЙ КЛАМП-КЛАМП	30090	РАЗМЕРЫ										
		DN	A	B	C	D	E	F	R	L	Rd x s	кг
	10	38,7	10	1,5		34						0,08
	15	47,7	16	1,5		34						0,09
	20	52,7	20	1,5		34						0,10
	25	62,7	26	1,5		50,5						0,20
	32	67,7	32	1,5		50,5						0,23
	40	72,7	38	1,5		50,5						0,28
	50	82,7	50	1,5		64						0,32
	65	92,7	66	2,0		91						0,62
	80	102,7	81	2,0		106						0,92
	100	115,8	100	2,0		119						1,13

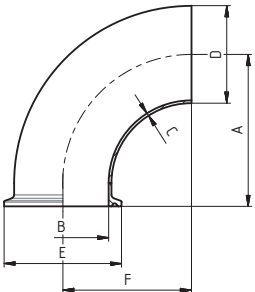
ОТВОД 90° ОСНАЩЕННЫЙ КЛАМП-СВАРКА	30091	РАЗМЕРЫ										
		DN	A	B	C	D	E	F	R	L	Rd x s	кг
	10		10	1,5	13	34						0,04
	15		16	1,5	19	34						0,05
	20		20	1,5	23	34						0,06
	25		26	1,5	29	50,5						0,08
	32		32	1,5	35	50,5						0,10
	40		38	1,5	41	50,5						0,11
	50		50	1,5	53	64						0,15
	65		66	2,0	70	91						0,34
	80		81	2,0	85	106						0,46
	100		100	2,0	104	119						0,56

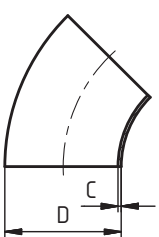
ОТВОД 45° СВАРКА-СВАРКА	30100	РАЗМЕРЫ										
		DN	A	B	C	D	E	F	R	L	Rd x s	кг
	10			1,5	12							0,01
	10			1,5	13							0,01
	15			1,5	18							0,02
	15			1,5	19							0,02
	20			1,5	22							0,02
	20			1,5	23							0,02
	25			1,5	28							0,04
	25			1,5	29							0,04
	32			1,5	34							0,05
	32			1,5	35							0,05
	40			1,5	40							0,07
	40			1,5	41							0,07
	50			1,5	52							0,10
	50			1,5	53							0,10
	65			2,0	70							0,21
	80			2,0	85							0,30
100			2,0	104							0,40	
125			2,0	129							0,95	
150			2,0	154							1,40	

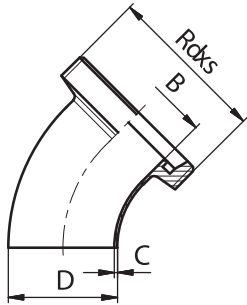
ОТВОД 45° ОСНАЩЕННЫЙ РЕЗЬБА-СВАРКА	30130	РАЗМЕРЫ										
		DN	A	B	C	D	E	F	R	L	Rd x s	кг
	10		10	1,5	13						28x1/8	0,05
	15		16	1,5	19						34x1/8	0,07
	20		20	1,5	23						44x1/6	0,13
	25		26	1,5	29						52x1/6	0,17
	32		32	1,5	35						58x1/6	0,21
	40		38	1,5	41						65x1/6	0,25
	50		50	1,5	53						78x1/6	0,35
	65		66	2,0	70						95x1/6	0,58
	80		81	2,0	85						110x1/4	0,86
	100		100	2,0	104						130x1/4	1,09
	125		125	2,0	129						160x1/4	2,10
	150		150	2,0	154						190x1/4	3,33

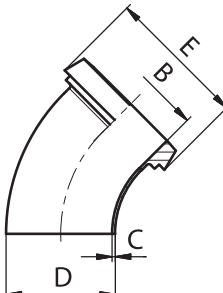
ОТВОД 45° ОСНАЩЕННЫЙ ШТУЦЕР КОНИЧЕСКИЙ-СВАРКА	30140		РАЗМЕРЫ									
	DN	A	B	C	D	E	F	R	L	Rd x s	кг	
	10		10	1,5	13	22,5					0,03	
	15		16	1,5	19	28,5					0,04	
	20		20	1,5	23	36,5					0,08	
	25		26	1,5	29	44					0,12	
	32		32	1,5	35	50					0,15	
	40		38	1,5	41	56					0,18	
	50		50	1,5	43	68,5					0,26	
	65		66	2,0	70	86					0,47	
	80		81	2,0	85	100					0,58	
	100		100	2,0	104	121					0,87	
	125		125	2,0	129	150					1,66	
	150		150	2,0	154	176					2,31	

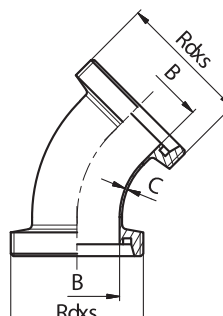
ОТВОД 45° ОСНАЩЕННЫЙ РЕЗЬБА-РЕЗЬБА	30150		РАЗМЕРЫ									
	DN	A	B	C	D	E	F	R	L	Rd x s	кг	
	10		10	1,5						28x1/8	0,09	
	15		16	1,5						34x1/8	0,13	
	20		20	1,5						44x1/6	0,24	
	25		26	1,5						52x1/6	0,31	
	32		32	1,5						58x1/6	0,36	
	40		38	1,5						65x1/6	0,44	
	50		50	1,5						78x1/6	0,60	
	65		66	2,0						95x1/6	0,95	
	80		81	2,0						110x1/4	1,43	
	100		100	2,0						130x1/4	1,77	
	125		125	2,0						160x1/4	3,26	
	150		150	2,0						190x1/4	5,31	

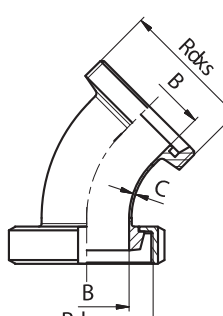
ОТВОД 45° ОСНАЩЕННЫЙ ГАЙКА-РЕЗЬБА	30160		РАЗМЕРЫ									
	DN	A	B	C	D	E	F	R	L	Rd x s	кг	
	10		10	1,5						28x1/8	0,15	
	15		16	1,5						34x1/8	0,19	
	20		20	1,5						44x1/6	0,32	
	25		26	1,5						52x1/6	0,43	
	32		32	1,5						58x1/6	0,52	
	40		38	1,5						65x1/6	0,62	
	50		50	1,5						78x1/6	0,86	
	65		66	2,0						95x1/6	1,41	
	80		81	2,0						110x1/4	1,93	
	100		100	2,0						130x1/4	2,61	
	125		125	2,0						160x1/4	4,34	
	150		150	2,0						190x1/4	6,66	

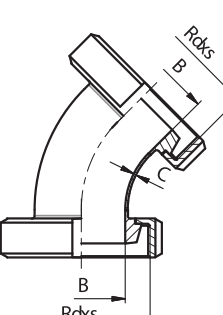
ОТВОД 45° ОСНАЩЕННЫЙ ГАЙКА-ГАЙКА	30170		РАЗМЕРЫ									
	DN	A	B	C	D	E	F	R	L	Rd x s	кг	
	10		10	1,5						28x1/8	0,20	
	15		16	1,5						34x1/8	0,25	
	20		20	1,5						44x1/6	0,40	
	25		26	1,5						52x1/6	0,56	
	32		32	1,5						58x1/6	0,67	
	40		38	1,5						65x1/6	0,81	
	50		50	1,5						78x1/6	1,12	
	65		66	2,0						95x1/6	1,88	
	80		81	2,0						110x1/4	2,43	
	100		100	2,0						130x1/4	3,44	
	125		125	2,0						160x1/4	5,43	
	150		150	2,0						190x1/4	8,01	

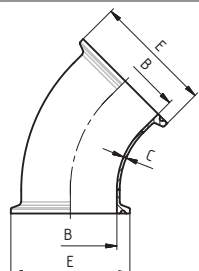
ОТВОД 45° ОСНАЩЕННЫЙ КЛАМП-КЛАМП	30190	РАЗМЕРЫ										
		DN	A	B	C	D	E	F	R	L	Rd x s	кг
	10		10	1,5		34						0,07
	15		16	1,5		34						0,08
	20		20	1,5		34						0,10
	25		26	1,5		50,5						0,12
	32		32	1,5		50,5						0,15
	40		38	1,5		50,5						0,15
	50		50	1,5		64						0,20
	65		66	2,0		91						0,47
	80		81	2,0		106						0,62
	100		100	2,0		119						0,72

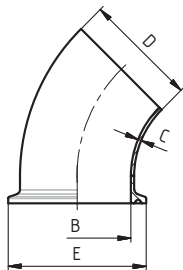
ОТВОД 45° ОСНАЩЕННЫЙ КЛАМПА-КЛАМПА	30191	РАЗМЕРЫ										
		DN	A	B	C	D	E	F	R	L	Rd x s	кг
	10		10	1,5	13	34						0,04
	15		16	1,5	19	34						0,05
	20		20	1,5	23	34						0,06
	25		26	1,5	29	50,5						0,08
	32		32	1,5	35	50,5						0,10
	40		38	1,5	41	50,5						0,11
	50		50	1,5	53	64						0,15
	65		66	2,0	70	91						0,34
	80		81	2,0	85	106						0,46
	100		100	2,0	104	119						0,56

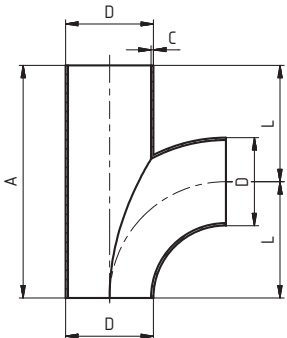
ТРОЙНИК ОТВЕТВИТЕЛЬНЫЙ СВАРКА-СВАРКА-СВАРКА	30300	РАЗМЕРЫ										
		DN	A	B	C	D	E	F	R	L	Rd x s	кг
	15	70		1,5	18					35		0,07
	15	70		1,5	19					35		0,07
	20	80		1,5	22					40		0,08
	20	80		1,5	23					40		0,08
	25	100		1,5	28					50		0,14
	25	100		1,5	29					50		0,14
	32	110		1,5	34					55		0,18
	32	110		1,5	35					55		0,18
	40	120		1,5	40					60		0,23
	40	120		1,5	41					60		0,23
	50	140		1,5	52					70		0,34
	50	140		1,5	53					70		0,34
	65	160		2,0	70					80		0,51
	80	180		2,0	85					90		0,91
	100	200		2,0	104					100		1,21
125	375		2,0	129					187,5		3,14	
150	450		2,0	154					225		5,38	

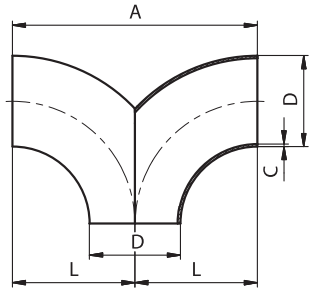
РАЗВЕТВИТЕЛЬ СВАРКА-СВАРКА-СВАРКА	30320	РАЗМЕРЫ										
		DN	A	B	C	D	E	F	R	L	Rd x s	кг
	15	70		1,5	18					35		0,06
	15	70		1,5	19					35		0,06
	20	80		1,5	22					40		0,08
	20	80		1,5	23					40		0,08
	25	100		1,5	28					50		0,15
	25	100		1,5	29					50		0,15
	32	110		1,5	34					55		0,20
	32	110		1,5	35					55		0,20
	40	120		1,5	40					60		0,26
	40	120		1,5	41					60		0,26
	50	140		1,5	52					70		0,40
	50	140		1,5	53					70		0,40
	65	160		2,0	70					80		0,81
	80	180		2,0	85					90		1,12
	100	200		2,0	104					100		1,52
125	375		2,0	129					187,5		3,62	
150	450		2,0	154					225		5,22	

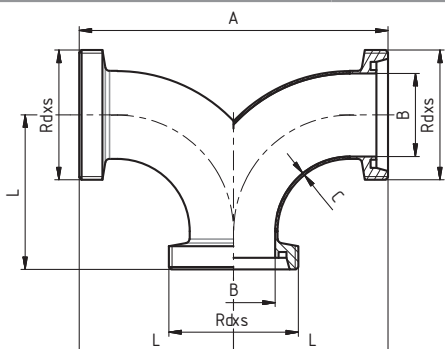
РАЗВЕТВИТЕЛЬ ОСНАЩЕННЫЙ РЕЗЬБА-РЕЗЬБА-РЕЗЬБА	30330		РАЗМЕРЫ								
	DN	A	B	C	D	E	F	R	L	Rd x s	кг
	25	144	26	1,5					72	52x1/6	0,55
	32	154	32	1,5					77	58x1/6	0,66
	40	164	38	1,5					82	65x1/6	0,82
	50	186	50	1,5					93	78x1/6	1,14
	65	210	66	2,0					105	95x1/6	1,92
	80	230	81	2,0					116	110x1/4	2,83
	100	260	100	2,0					130	130x1/4	3,57
	125	446	125	2,0					223	160x1/4	7,11
	150	530	150	2,0					265	190x1/4	11,15

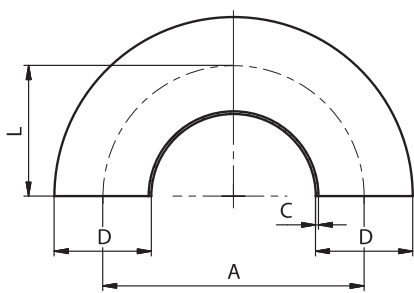
ОТВОД 180° СВАРКА-СВАРКА	30340		РАЗМЕРЫ								
	DN	A	B	C	D	E	F	R	L	Rd x s	кг
	10	52		1,5	12				26		0,04
	15	70		1,5	18				35		0,08
	20	80		1,5	22				40		0,08
	25	100		1,5	28				50		0,16
	32	112		1,5	34				56		0,20
	40	126		1,5	40				63		0,40
	50	144		1,5	52				72		0,40
	65	170		2,0	70				85		0,80
	80	186		2,0	85				93		1,12
100	220		2,0	104				110		1,52	

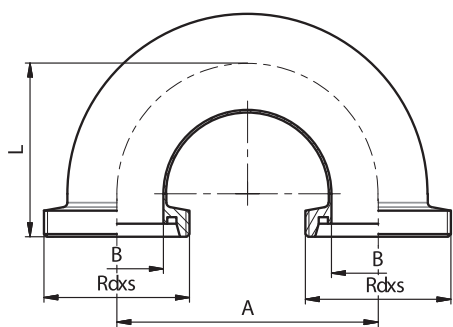
ОТВОД 180° ОСНАЩЕННЫЙ РЕЗЬБА-РЕЗЬБА	30350		РАЗМЕРЫ								
	DN	A	B	C	D	E	F	R	L	Rd x s	кг
	10	52	10						43	28x1/8	0,12
	15	70	16						52	34x1/8	0,18
	20	80	20						59	44x1/6	0,31
	25	100	26						72	52x1/6	0,43
	32	112	32						77	58x1/6	0,52
	40	126	38						82	65x1/6	0,65
	50	144	50						93	78x1/6	0,92
	65	170	66						105	95x1/6	1,39
	80	186	81						116	110x1/4	2,32
	100	220	100						130	130x1/4	2,98
	125	375	125						223	160x1/4	6,09
150	450	150						265	190x1/4	9,37	

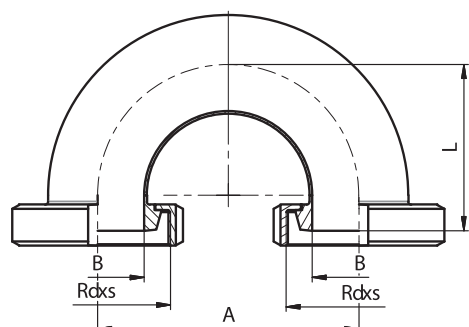
ОТВОД 180° ОСНАЩЕННЫЙ ГАЙКА-ГАЙКА	30360		РАЗМЕРЫ								
	DN	A	B	C	D	E	F	R	L	Rd x s	кг
	10	52	10						40	28x1/8	0,23
	15	70	16						49	34x1/8	0,31
	20	80	20						56	44x1/6	0,48
	25	100	26						68	52x1/6	0,54
	32	112	32						73	58x1/6	0,83
	40	126	38						78	65x1/6	1,02
	50	144	50						89	78x1/6	1,44
	65	170	66						101	95x1/6	2,31
	80	186	81						111	110x1/4	3,32
	100	220	100						125	130x1/4	4,65
	125	375	125						214,5	160x1/4	8,25
150	450	150						254	190x1/4	12,07	

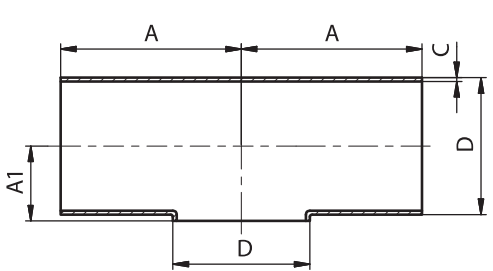
ТРОЙНИК КОРОТКИЙ СВАРКА-СВАРКА-СВАРКА	30400	РАЗМЕРЫ										
		DN	A	A1	C	D	E	F	R	L	Rd x s	кг
	10	26	8	1,5	12							0,02
	10	26	8	1,5	13							0,02
	15	35	11	1,5	18							0,04
	15	35	11	1,5	19							0,04
	20	40	13	1,5	22							0,06
	20	40	13	1,5	23							0,06
	25	50	16	1,5	28							0,10
	25	50	16	1,5	29							0,10
	32	55	18	1,5	34							0,13
	32	55	18	1,5	35							0,13
	40	60	23	1,5	40							0,17
	40	60	23	1,5	41							0,17
	50	70	29	1,5	52							0,26
	50	70	29	1,5	53							0,26
	65	80	38	2,0	70							0,53
	80	90	45,5	2,0	85							0,72
100	100	52	2,0	104							0,98	
125	187,5	66,5	2,0	129							2,32	
150	225	79	2,0	154							3,32	

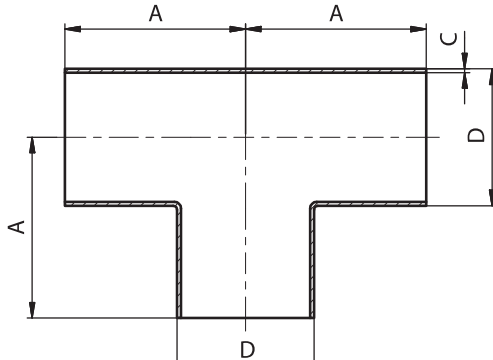
ТРОЙНИК ДЛИННЫЙ СВАРКА-СВАРКА-СВАРКА	30410	РАЗМЕРЫ										
		DN	A	B	C	D	E	F	R	L	Rd x s	кг
	10	26		1,5	12							0,03
	10	26		1,5	13							0,03
	15	35		1,5	18							0,06
	15	35		1,5	19							0,06
	20	40		1,5	22							0,08
	20	40		1,5	23							0,08
	25	50		1,5	28							0,13
	25	50		1,5	29							0,13
	32	55		1,5	34							0,18
	32	55		1,5	35							0,18
	40	60		1,5	40							0,22
	40	60		1,5	41							0,22
	50	70		1,5	52							0,34
	50	70		1,5	53							0,34
	65	80		2,0	70							0,67
	80	90		2,0	85							0,91
100	100		2,0	104							1,21	
125	187,5		2,0	129							3,08	
150	225		2,0	154							4,43	

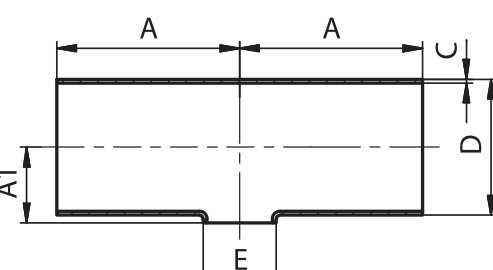
ТРОЙНИК ПЕРЕХОДНОЙ КОРОТКИЙ СВАРКА-СВАРКА-СВАРКА	30440	РАЗМЕРЫ												
		DN	A	A1	C	D	E	кг	DN	A	A1	C	D	E
	15/10	35	11	1,5	19	13	0,04	50/40	70	28	1,5	53	41	0,27
	20/10	40	13	1,5	23	13	0,07	65/25	80	38	2,0	70	29	0,46
	20/15	40	13	1,5	23	19	0,07	65/32	80	38	2,0	70	35	0,49
	25/10	50	16	1,5	29	13	0,09	65/40	80	38	2,0	70	41	0,51
	25/15	50	16	1,5	29	19	0,10	65/50	80	38	2,0	70	53	0,51
	25/20	50	16	1,5	29	23	0,14	80/40	90	46	2,0	85	41	0,70
	32/10	55	19	1,5	35	13	0,14	80/50	90	46	2,0	85	53	0,68
	32/15	55	19	1,5	35	19	0,14	80/65	90	46	2,0	85	70	0,81
	32/20	55	19	1,5	35	23	0,14	100/50	100	55	2,0	104	53	0,99
	32/25	55	19	1,5	35	29	0,14	100/65	100	55	2,0	104	70	0,96
	40/15	60	22	1,5	41	19	0,16	100/80	100	55	2,0	104	85	0,92
	40/20	60	22	1,5	41	23	0,16	125/65	187,5	66,5	2,0	129	70	2,25
	40/25	60	22	1,5	41	29	0,17	125/80	187,5	66,5	2,0	129	85	2,18
	40/32	60	22	1,5	41	35	0,17	125/100	187,5	66,5	2,0	129	104	2,08
	50/20	70	28	1,5	53	23	0,25	150/80	225	79	2,0	154	85	3,25
	50/25	70	28	1,5	53	29	0,26	150/100	225	79	2,0	154	104	3,16
50/32	70	28	1,5	53	35	0,26	150/125	225	79	2,0	154	129	3,03	

ТРОЙНИК ОСНАЩЕННЫЙ РЕЗЬБА-РЕЗЬБА-РЕЗЬБА	30450		РАЗМЕРЫ									
	DN	A	B	C	D	E	F	R	L	Rd x s	кг	
	10	43	10							28x1/8	0,16	
	15	52	16							34x1/8	0,23	
	20	59	20							44x1/6	0,40	
	25	72	26							52x1/6	0,53	
	32	77	32							58x1/6	0,64	
	40	82	38							65x1/6	0,79	
	50	93	50							78x1/6	1,08	
	65	105	66							95x1/6	1,78	
	80	116	81							110x1/4	2,62	
	100	130	100							130x1/4	3,26	
	125	223	125							160x1/4	6,57	
	150	265	150							190x1/4	10,38	

ТРОЙНИК ОСНАЩЕННЫЙ РЕЗЬБА-РЕЗЬБА-ГАЙКА	30460		РАЗМЕРЫ									
	DN	A	A1	B	D	E	F	R	L	Rd x s	кг	
	10	43	40	10						28x1/8	0,21	
	15	52	49	16						34x1/8	0,29	
	20	59	56	20						44x1/6	0,48	
	25	72	68	26						52x1/6	0,62	
	32	77	73	32						58x1/6	0,80	
	40	82	78	38						65x1/6	0,97	
	50	93	89	50						78x1/6	1,35	
	65	105	101	66						95x1/6	2,24	
	80	116	111	81						110x1/4	3,11	
	100	130	125	100						130x1/4	4,10	
	125	223	214,5	125						160x1/4	7,65	
	150	265	254	150						190x1/4	9,34	

ТРОЙНИК ОСНАЩЕННЫЙ РЕЗЬБА-ГАЙКА-РЕЗЬБА	30470		РАЗМЕРЫ									
	DN	A	A1	B	D	E	F	R	L	Rd x s	кг	
	10	43	40	10						28x1/8	0,21	
	15	52	49	16						34x1/8	0,29	
	20	59	56	20						44x1/6	0,48	
	25	72	68	26						52x1/6	0,62	
	32	77	73	32						58x1/6	0,80	
	40	82	78	38						65x1/6	0,97	
	50	93	89	50						78x1/6	1,35	
	65	105	101	66						95x1/6	2,24	
	80	116	111	81						110x1/4	3,11	
	100	130	125	100						130x1/4	4,10	
	125	223	214,5	125						160x1/4	7,65	
	150	265	254	150						190x1/4	9,34	

ТРОЙНИК ОСНАЩЕННЫЙ РЕЗЬБА-ГАЙКА-ГАЙКА	30480		РАЗМЕРЫ									
	DN	A	A1	B	D	E	F	R	L	Rd x s	кг	
	10	43	40	10						28x1/8	0,27	
	15	52	49	16						34x1/8	0,35	
	20	59	56	20						44x1/6	0,56	
	25	72	68	26						52x1/6	0,79	
	32	77	73	32						58x1/6	0,95	
	40	82	78	38						65x1/6	1,16	
	50	93	89	50						78x1/6	1,60	
	65	105	101	66						95x1/6	2,70	
	80	116	111	81						110x1/4	3,61	
	100	130	125	100						130x1/4	4,93	
	125	223	214,5	125						160x1/4	8,73	
	150	265	254	150						190x1/4	13,06	

ТРОЙНИК ОСНАЩЕННЫЙ ГАЙКА-ГАЙКА-РЕЗЬБА	30490		РАЗМЕРЫ									
	DN	A	A1	B	D	E	F	R	L	Rd x s	кг	
	10	43	40	10							28x1/8	0,27
	15	52	49	16							34x1/8	0,35
	20	59	56	20							44x1/6	0,56
	25	72	68	26							52x1/6	0,79
	32	77	73	32							58x1/6	0,95
	40	82	78	38							65x1/6	1,16
	50	93	89	50							78x1/6	1,60
	65	105	101	66							95x1/6	2,70
	80	115	111	81							110x1/4	3,61
	100	130	125	100							130x1/4	4,93
	125	223	214,5	125							160x1/4	8,73
150	265	254	150							190x1/4	13,06	

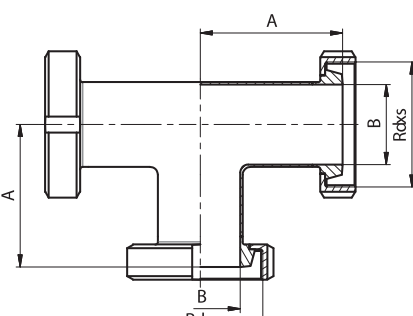
ТРОЙНИК ОСНАЩЕННЫЙ ГАЙКА-ГАЙКА-ГАЙКА	30500		РАЗМЕРЫ									
	DN	A	B	C	D	E	F	R	L	Rd x s	кг	
	10	40	10								28x1/8	0,32
	15	49	16								34x1/8	0,41
	20	56	20								44x1/6	0,64
	25	68	26								52x1/6	0,92
	32	73	32								58x1/6	1,11
	40	78	38								65x1/6	1,34
	50	89	50								78x1/6	1,86
	65	101	66								95x1/6	3,17
	80	111	81								110x1/4	4,11
	100	125	100								130x1/4	5,76
	125	214,5	125								160x1/4	9,81
150	254	150								190x1/4	14,41	

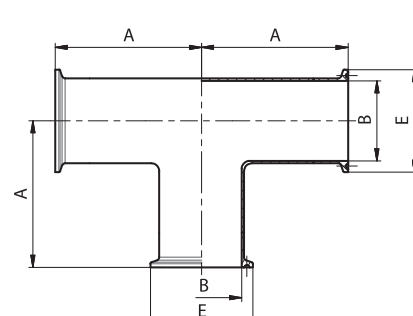
ТРОЙНИК ОСНАЩЕННЫЙ ДЛИННЫЙ КЛАМП-КЛАМП-КЛАМП	30520		РАЗМЕРЫ									
	DN	A	B	C	D	E	F	R	L	Rd x s	кг	
	10	44	10			34					0,13	
	15	53	16			34					0,15	
	20	58	20			50,5					0,16	
	25	71,5	26			50,5					0,34	
	32	76,5	32			50,5					0,40	
	40	81,5	38			50,5					0,40	
	50	91,5	50			64					0,54	
	65	108	66			91					1,24	
	80	118	81			106					1,59	
	100	128	100			119					1,88	
	125	215,5	125			155					4,64	
150	253	150			183					6,53		

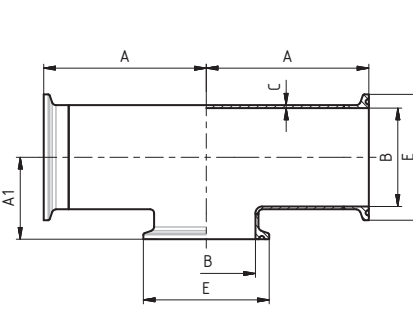
ТРОЙНИК ОСНАЩЕННЫЙ КОРОТКИЙ КЛАМП-КЛАМП-КЛАМП	30521		РАЗМЕРЫ									
	DN	A	A1	B	C	E	F	R	L	Rd x s	кг	
	10	38,7	20,7	10	1,5	34					0,13	
	15	47,7	23,7	16	1,5	34					0,15	
	20	52,7	25,7	20	1,5	50,5					0,16	
	25	62,7	28,7	26	1,5	50,5					0,34	
	32	67,7	30,7	32	1,5	50,5					0,40	
	40	72,7	35,7	38	1,5	50,5					0,40	
	50	82,7	41,7	50	1,5	64					0,54	
	65	92,7	50,7	66	2,0	91					1,24	
	80	102,7	58,2	81	2,0	106					1,59	
	100	112,7	64,7	100	2,0	119					1,88	

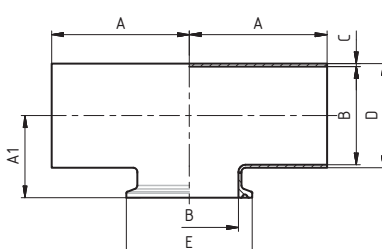
ТРОЙНИК ОСНАЩЕННЫЙ КОРОТКИЙ СВАРКА-КЛАМП-СВАРКА	30522		РАЗМЕРЫ								
	DN	A	A1	B	C	D	E	R	L	Rd x s	кг
	10	26	20,7	10	1,5	13	34				0,07
	15	35	23,7	16	1,5	19	34				0,09
	20	40	25,7	20	1,5	23	50,5				0,10
	25	50	28,7	26	1,5	29	50,5				0,28
	32	55	30,7	32	1,5	35	50,5				0,34
	40	60	35,7	38	1,5	41	50,5				0,34
	50	70	41,7	50	1,5	53	64				0,48
	65	80	50,7	66	2,0	70	91				1,18
	80	90	58,2	81	2,0	85	106				1,53
	100	100	64,7	100	2,0	104	119				1,82

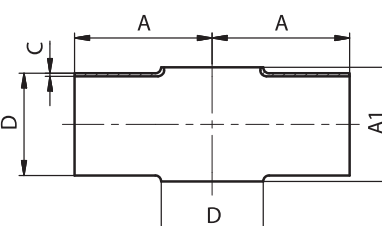
КРЕСТОВИНА КОРОТКАЯ СВАРКА-СВАРКА-СВАРКА-СВАРКА	30540		РАЗМЕРЫ								
	DN	A	A1	C	D	E	F	R	L	Rd x s	кг
	25	50	30	1,5	28						0,09
	25	50	30	1,5	29						0,09
	32	55	36	1,5	34						0,13
	32	55	36	1,5	35						0,13
	40	60	44	1,5	40						0,17
	40	60	44	1,5	41						0,17
	50	70	58	1,5	52						0,25
	50	70	58	1,5	53						0,25
	65	80	76	2,0	70						0,51
	80	90	91	2,0	85						0,69
100	100	110	2,0	104						0,93	

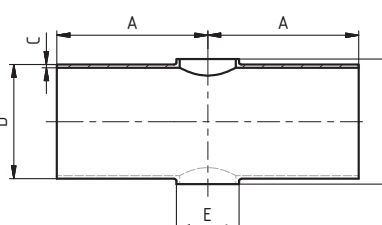
КРЕСТОВИНА ПЕРЕХОДНАЯ КОРОТКАЯ СВАРКА-СВАРКА-СВАРКА-СВАРКА	30550		РАЗМЕРЫ											
	DN	A	A1	C	D	E	кг	DN	A	A1	C	D	E	кг
	15/10	35	22	1,5	19	13	0,03	50/40	70	56	1,5	53	41	0,23
	20/10	40	26	1,5	23	13	0,05	65/25	80	76	2,0	70	29	0,41
	20/15	40	26	1,5	23	19	0,05	65/32	80	76	2,0	70	35	0,44
	25/10	50	32	1,5	29	13	0,07	65/40	80	76	2,0	70	41	0,46
	25/15	50	32	1,5	29	19	0,09	65/50	80	76	2,0	70	53	0,46
	25/20	50	32	1,5	29	23	0,09	80/40	90	92	2,0	85	41	0,64
	32/10	55	38	1,5	35	13	0,10	80/50	90	92	2,0	85	53	0,62
	32/15	55	38	1,5	35	19	0,10	80/65	90	92	2,0	85	70	0,75
	32/20	55	38	1,5	35	23	0,09	100/50	100	110	2,0	104	53	0,91
	32/25	55	38	1,5	35	29	0,09	100/65	100	110	2,0	104	70	0,89
	40/15	60	44	1,5	41	19	0,13	100/80	100	110	2,0	104	85	0,81
	40/20	60	44	1,5	41	23	0,13	125/65	187,5	133	2,0	129	70	2,19
	40/25	60	44	1,5	41	29	0,14	125/80	187,5	133	2,0	129	85	2,01
	40/32	60	44	1,5	41	35	0,14	125/100	187,5	133	2,0	129	104	1,85
	50/20	70	56	1,5	53	23	0,22	150/80	225	158	2,0	154	85	3,03
	50/25	70	56	1,5	53	29	0,23	150/100	225	158	2,0	154	104	2,85
	50/32	70	56	1,5	53	35	0,23	150/125	225	158	2,0	154	129	2,63

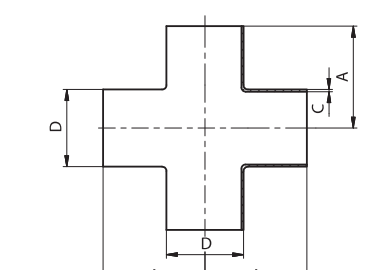
КРЕСТОВИНА ДЛИННАЯ СВАРКА-СВАРКА-СВАРКА-СВАРКА	30560		РАЗМЕРЫ								
	DN	A	B	C	D	E	F	R	L	Rd x s	кг
	25	50		1,5	28						0,18
	25	50		1,5	29						0,18
	32	55		1,5	34						0,22
	32	55		1,5	35						0,22
	40	60		1,5	40						0,28
	40	60		1,5	41						0,28
	50	70		1,5	52						0,42
	50	70		1,5	53						0,42
	65	80		2,0	70						0,80
	80	90		2,0	85						1,01
100	100		2,0	104						1,39	

ПЕРЕХОД КОНЦЕНТРИЧЕСКИЙ СВАРКА-СВАРКА	30600	РАЗМЕРЫ									
		DN	A	B	D	кг	DN	A	B	D	кг
		15/10	11	19	13	0,01	65/40	52	70	41	0,12
		20/10	18	23	13	0,01	65/50	30	70	53	0,08
		20/15	7	23	19	0,01	80/50	56	85	53	0,20
		25/15	18	29	19	0,02	80/65	27	85	70	0,11
		25/20	11	29	23	0,01	100/65	60	104	70	0,26
		32/20	22	35	23	0,02	100/80	35	104	85	0,16
		32/25	11	35	29	0,01	125/80	79	129	85	0,42
		40/20	33	41	23	0,02	125/100	45	129	104	0,27
		40/25	22	41	29	0,03	150/100	90	154	104	0,60
		40/32	11	41	35	0,01	150/125	45	154	129	0,33
		50/25	44	53	29	0,06	200/150	90	204	154	0,80
		50/32	33	53	35	0,05	250/150	297	253	154	2,90
		50/40	23	53	41	0,04					

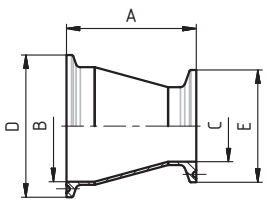
ПЕРЕХОД ОСНАЩЕННЫЙ КОНЦЕНТРИЧЕСКИЙ КЛАМП-КЛАМП	30609	РАЗМЕРЫ											
		DN	A	B	C	D	E	F	R	L	Rd x s	кг	
		32/25	36,5	32	26	50,5	50,5						0,11
		40/25	48	38	26	50,5	50,5						0,11
		40/32	37	38	32	50,5	50,5						0,11
		50/25	70	50	26	64	50,5						0,14
		50/32	59	50	32	64	50,5						0,15
		50/40	48,5	50	38	64	50,5						0,13
		65/40	77,5	66	38	91	50,5						0,31
		65/50	55,5	66	50	91	64						0,18
		80/50	84	81	50	106	64						0,40
		80/65	53	81	66	106	91						0,39
		100/65	87	100	66	119	91						0,55
		100/80	60,5	100	81	119	106						0,48

ПЕРЕХОД ЭКСЦЕНТРИЧЕСКИЙ СВАРКА-СВАРКА	30610	РАЗМЕРЫ											
		DN	A	B	C	D	E	F	R	L	Rd x s	кг	
		32/25	16,5	35		29							0,02
		40/25	33	41		29							0,03
		40/32	16,5	41		35							0,02
		50/25	44	53		29							0,05
		50/32	33	53		35							0,05
		50/40	33	53		41							0,04
		65/40	51	70		41							0,14
		65/50	44	70		53							0,09
		80/50	56	85		53							0,19
		80/65	41,2	85		70							0,10
	100/65	61	104		70							0,26	
	100/80	52,5	104		85							0,16	

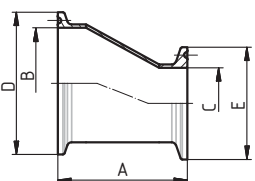
ПЕРЕХОД ОСНАЩЕННЫЙ ЭКСЦЕНТРИЧЕСКИЙ КЛАМП-КЛАМП	30619	РАЗМЕРЫ											
		DN	A	B	C	D	E	F	R	L	Rd x s	кг	
		32/25	41,9	32	26	50,5	50,5						0,11
		40/25	58,4	38	26	50,5	50,5						0,11
		40/32	41,9	38	32	50,5	50,5						0,11
		50/25	69,4	50	26	64	50,5						0,14
		50/32	58,4	50	32	64	50,5						0,15
		50/40	58,4	50	38	64	50,5						0,13
		65/40	76,4	66	38	91	50,5						0,31
		65/50	69,4	66	50	91	64						0,18
		80/50	81,4	81	50	106	64						0,40
		80/65	66,6	81	66	106	91						0,39
		100/65	89,5	100	66	119	91						0,55
		100/80	81	100	81	119	106						0,48

ПЕРЕХОД КОНЦЕНТРИЧЕСКИЙ ДЛИННЫЙ СВАРКА-СВАРКА	30620	РАЗМЕРЫ										
		DN	A	A1	B	C	D	F	R	L	Rd x s	кг
	15/10	45	18	18	1,5	12						0,02
	20/10	63	18	22	1,5	12						0,04
	20/15	60	20	22	1,5	18						0,04
	25/15	60	20	28	1,5	18						0,05
	25/20	60	20	28	1,5	22						0,05
	32/25	80	30	34	1,5	28						0,09
	40/25	102	35	40	1,5	28						0,12
	40/32	88	35	40	1,5	34						0,12
	50/25	115	40	52	1,5	28						0,17
	50/32	129	40	52	1,5	34						0,20
	50/40	113	40	52	1,5	40						0,19
	65/32	125	40	70	2,0	34						0,24
	65/40	120	40	70	2,0	40						0,33
	65/50	130	40	70	2,0	52						0,39
	80/40	140	40	85	2,0	40						0,44
	80/50	125	40	85	2,0	52						0,43
	80/65	120	40	85	2,0	70						0,46
	100/50	160	40	104	2,0	52						0,63
	100/65	127	40	104	2,0	70						0,56
	100/85	120	40	104	2,0	85						0,56

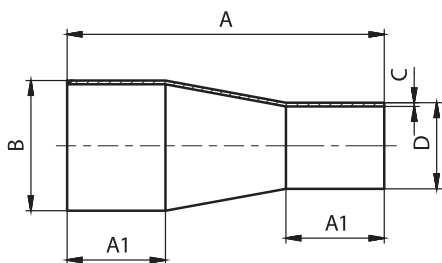

ПЕРЕХОД ЭКСЦЕНТРИЧЕСКИЙ ДЛИННЫЙ СВАРКА-СВАРКА	30630	РАЗМЕРЫ										
		DN	A	A1	B	C	D	F	R	L	Rd x s	кг
	20/15	60	20	22	1,5	18						0,04
	25/15	60	20	28	1,5	18						0,05
	25/20	60	20	28	1,5	22						0,05
	32/25	100	40	34	1,5	28						0,11
	40/25	100	40	40	1,5	28						0,13
	40/32	100	40	40	1,5	34						0,13
	50/25	130	40	52	1,5	28						0,20
	50/32	125	40	52	1,5	34						0,20
	50/40	100	40	52	1,5	40						0,17
	65/40	140	40	70	2,0	40						0,39
	65/50	125	40	70	2,0	52						0,38
	80/50	130	40	85	2,0	52						0,46
	80/65	110	40	85	2,0	70						0,43
	100/65	155	40	104	2,0	70						0,70
	100/85	130	40	104	2,0	85						0,62
	80/50	125	40	85	2,0	52						0,43
	80/65	120	40	85	2,0	70						0,46
	100/50	160	40	104	2,0	52						0,63
	100/65	127	40	104	2,0	70						0,56
	100/85	120	40	104	2,0	85						0,56

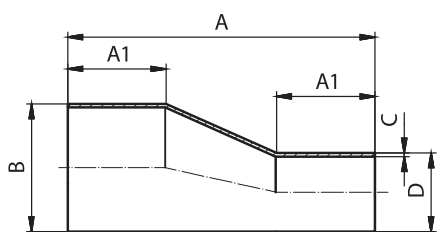

ОТВОД 90° СВАРКА-СВАРКА	31010	РАЗМЕРЫ										
		SMS	DN	A	B	C	D	E	F	r	L	Rd x s
	25	37,5		1,25	25				37,5			0,05
	38	57		1,25	38				57			0,12
	51	76,5		1,25	51				76,5			0,18
	63,5	95,25		1,5	63,5				95,25			0,33
	76	114,15		1,6	76,1				114,15			0,50
	101,6	150		2,0	101,6				150			0,87

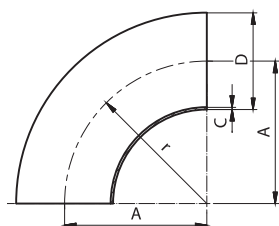

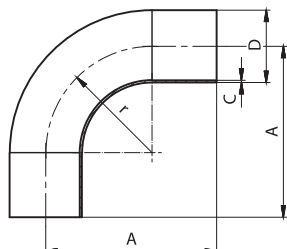
ОТВОД 90° УДЛИНЕННЫЙ СВАРКА-СВАРКА	31020		РАЗМЕРЫ										
	SMS	DN	A	B	C	D	E	F	r	L	Rd x s	кг	
		25	75		1,25	25			38			0,15	
		38	90		1,25	38			56			0,21	
		51	100		1,25	51			72			0,31	
		63,5	115		1,5	63,5			84			0,45	
		76	130		1,6	76,1			85			0,67	
		101,6	150		2,0	101,6			110			1,27	

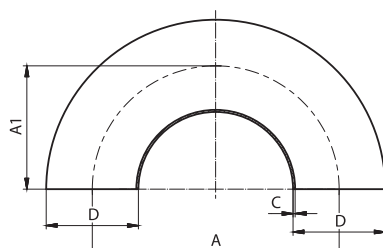
ОТВОД 180° СВАРКА-СВАРКА	31340		РАЗМЕРЫ										
	SMS	DN	A	A1	C	D	E	F	R	L	Rd x s	кг	
		25	75	37,5	1,25	25						0,05	
		38	114	57	1,25	38						0,12	
		51	153	76,5	1,25	51						0,18	
		63,5	190,5	95,25	1,5	63,5						0,33	
		76	228,3	114,15	1,6	76,1						0,50	
		101,6	304,2	152,1	2,0	101,6						0,87	

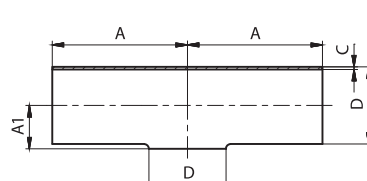
ТРОЙНИК КОРОТКИЙ СВАРКА-СВАРКА-СВАРКА	31400		РАЗМЕРЫ										
	SMS	DN	A	A1	C	D	E	F	R	L	Rd x s	кг	
		25	55	14	1,25	25						0,11	
		38	70	21	1,25	38						0,25	
		51	82	28,5	1,25	51						0,47	
		63,5	105	36	1,5	63,5						0,75	
		76	110	43	1,6	76,1						1,07	
		101,6	150	58	2,0	101,6						2,30	

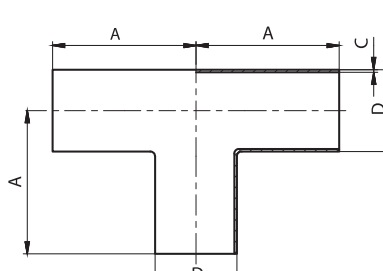
ТРОЙНИК ДЛИННЫЙ СВАРКА-СВАРКА-СВАРКА	31410		РАЗМЕРЫ										
	SMS	DN	A	B	C	D	E	F	R	L	Rd x s	кг	
		25	55		1,25	25						0,11	
		35	70		1,25	38						0,25	
		51	82		1,25	51						0,47	
		63,5	105		1,5	63,5						0,75	
		76	110		1,6	76,1						1,07	
		101,6	150		2,0	101,6						2,30	

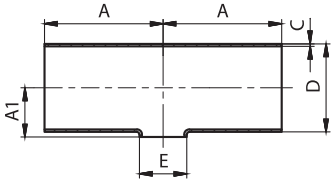
ТРОЙНИК КОРОТКИЙ СВАРКА-СВАРКА-СВАРКА	31440	РАЗМЕРЫ										
	SMS	DN	A	A1	C	D	E	F	R	L	Rd x s	кг
	38/25	70	21	1,25	38	25						0,17
	51/25	82	29	1,25	51	25						0,26
	51/38	82	29	1,25	51	38						0,27
	63/25	105	34,5	1,5	63,5	25						0,49
	63/38	105	35	1,5	63,5	38						0,51
	63/51	105	36	1,5	63,5	51						0,51
	76/25	110	41	1,6	76,1	25						0,60
	76/38	110	42	1,6	76,1	38						0,68
	76/51	110	43	1,6	76,1	51						0,68
	76/63	110	43	1,6	76,1	63,5						0,81
	101/25	150	56	2,0	101,6	25						0,82
	101/38	150	56	2,0	101,6	38						0,90
	101/51	150	57	2,0	101,6	51						0,95
	101/63	150	58	2,0	101,6	63,5						0,96
101/76	150	58	2,0	101,6	76,1						0,92	

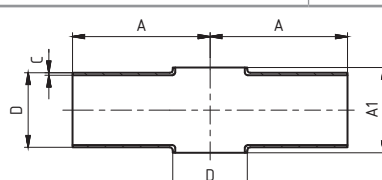
КРЕСТОВИНА СВАРКА-СВАРКА-СВАРКА-СВАРКА	31540	РАЗМЕРЫ										
	SMS	DN	A	A1	C	D	E	F	R	L	Rd x s	кг
	25	55	28	1,25	25							0,09
	38	70	42	1,25	38							0,19
	51	82	57	1,25	51							0,25
	63,5	105	72	1,5	63,5							0,51
	76	110	86	1,6	76,1							0,69
	101,6	150	116	2,0	101,6							0,93

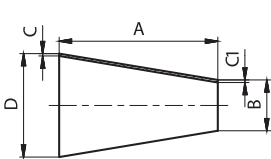
ПЕРЕХОД КОНЦЕНТРИЧЕСКИЙ СВАРКА-СВАРКА	31600	РАЗМЕРЫ										
	SMS	DN	A	B	C	C1	D	F	R	L	Rd x s	кг
	38/25	39	25	1,2	1,2	38						0,04
	50/25	78	25	1,2	1,2	51						0,09
	50/38	39	38	1,2	1,2	51						0,05
	63/25	116	25	1,5	1,2	63,5						0,20
	63/38	76	38	1,5	1,2	63,5						0,15
	63/50	38	51	1,5	1,2	63,5						0,09
	76/25	153	25	1,6	1,2	76,1						0,23
	76/38	114	38	1,6	1,2	76,1						0,26
	76/50	75	51	1,6	1,2	76,1						0,19
	76/63	38	63,5	1,6	1,5	76,1						0,11
	104/38	198	38	2,0	1,2	104						0,70
	104/50	159	51	2,0	1,2	104						0,61
	104/63	122	63,5	2,0	1,5	104						0,51
	104/76	84	76,1	2,0	1,6	104						0,38

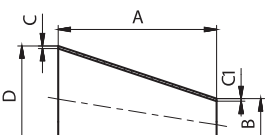
ПЕРЕХОД ЭКСЦЕНТРИЧЕСКИЙ СВАРКА-СВАРКА	31610	РАЗМЕРЫ										
	SMS	DN	A	B	C	C1	D	F	R	L	Rd x s	кг
	38/25	39	25	1,2	1,2	38						0,04
	50/25	78	25	1,2	1,2	51						0,09
	50/38	39	38	1,2	1,2	51						0,05
	63/25	116	25	1,5	1,2	63,5						0,20
	63/38	76	38	1,5	1,2	63,5						0,15
	63/50	38	51	1,5	1,2	63,5						0,09
	76/25	153	25	1,6	1,2	76,1						0,23
	76/38	114	38	1,6	1,2	76,1						0,26
	76/50	75	51	1,6	1,2	76,1						0,19
	76/63	38	63,5	1,6	1,5	76,1						0,11
	104/38	198	38	2,0	1,2	104						0,70
	104/50	159	51	2,0	1,2	104						0,61
	104/63	122	63,5	2,0	1,5	104						0,51
	104/76	84	76,1	2,0	1,6	104						0,38

A close-up photograph of a mechanical device, possibly a valve or a pump, with a prominent red ring. The device is made of polished metal and features several hexagonal bolts. The background is a solid blue color.

3

Регулирующ я рм тура

3 творы дисковые
Кл п ны ш ровые
Кл п ны седельные

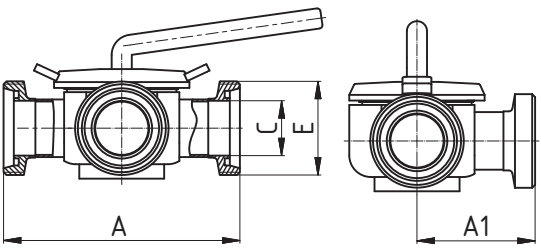
КРАН ПРОБКОВЫЙ ТРЁХХОДОВОЙ РЕЗЬБА-РЕЗЬБА-РЕЗЬБА	40110	РАЗМЕРЫ							
		DN	A	C	A1	резьб E	резьб DIN 405		кг
		40	184,5	38	92,2	65x1/6"			
		50	231,5	50	115,8	78x1/6"			

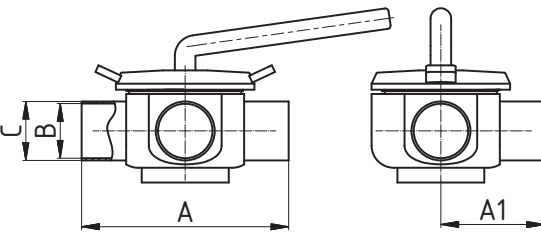
КРАН ПРОБКОВЫЙ ТРЁХХОДОВОЙ СВАРКА-СВАРКА-СВАРКА	40111	РАЗМЕРЫ									кг
		DN	A	A1	B	C					
		40	140,5	70,2	38	41					
		50	185,5	92,8	50	53					

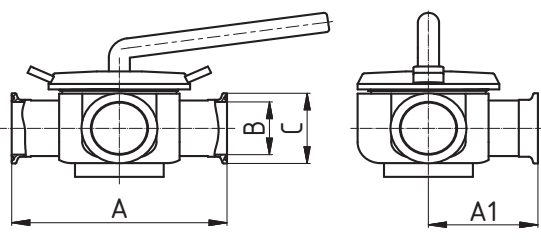
КРАН ПРОБКОВЫЙ ТРЁХХОДОВОЙ КЛАМП-КЛАМП-КЛАМП	40119	РАЗМЕРЫ									кг
		DN	A	A1	B	C					
		40	165,9	82,9	38	50,5					
		50	210,9	105,5	50	64					

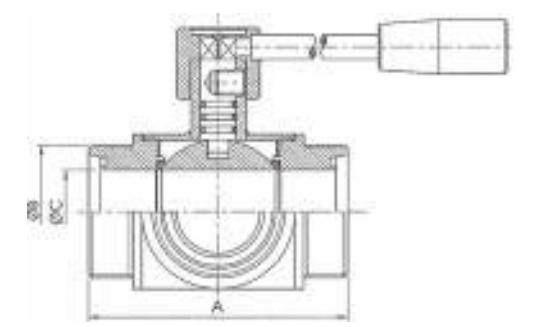
КРАН ШАРОВОЙ ТРЁХХОДОВОЙ РЕЗЬБА-РЕЗЬБА-РЕЗЬБА	40210	РАЗМЕРЫ								кг
		DN	A	резьб B	C					
		25	136	52x1/6"	25					
		32	138	58x1/6"	31					
		40	158	65x1/6"	37					
		50	170	78x1/6"	49					
		65	204	95x1/6"	66					
		80	130	110x1/4"	81					
		100	264	130x1/4"	100					
		125	346	160x1/4"	120					

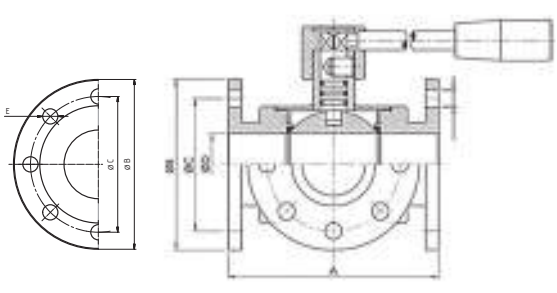
КРАН ШАРОВОЙ ТРЁХХОДОВОЙ ФЛАНЕЦ-ФЛАНЕЦ-ФЛАНЕЦ	40240		РАЗМЕРЫ								
	DN	A	B	C	D	E				кг	
	25	150	115	85	25	14x4					
	32	180	140	100	31	18x4					
	40	200	150	110	37	18x4					
	50	220	165	125	49	18x4					
	65	240	185	145	66	18x4					
	80	260	200	160	81	18x8					
	100	300	220	180	100	18x8					
	125	380	250	210	120	18x8					

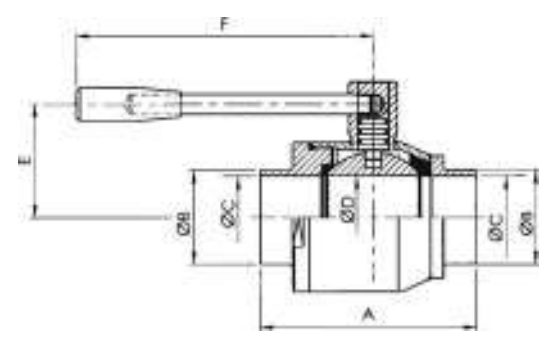
КРАН ШАРОВОЙ СВАРКА-СВАРКА	40510		РАЗМЕРЫ							
	DN	A	B	C	D	E	F			кг
	15	78	21	16	16	40	90			
	20	78	25	20	19	40	90			
	25	84	31	26	24	44	146			
	32	106	37	32	33	50	146			
	40	124	43	40	40	64	185			
	50	134	55	49	49,5	68	185			
	65	145	72	65	65	95	243			
	80	179	87	79	79	104	243			
	100	205	106	99	99	122	273			
	125	225	132	119	119	135	273			

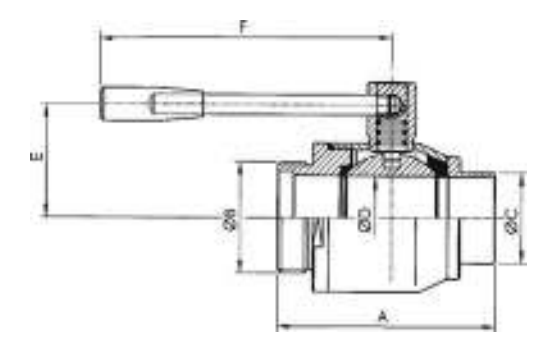
КРАН ШАРОВОЙ РЕЗЬБА-СВАРКА	40520		РАЗМЕРЫ								
	DN	A	резьб DIN 405 B	C	D	E	F			кг	
	25	86	52x1/6"	31	24	44	146				
	32	104	58x1/6"	37	33	50	146				
	40	125	65x1/6"	43	40	64	185				
	50	134	78x1/6"	55	49,5	68	185				
	65	145	95x1/6"	72	65	95	243				
	80	179	110x1/4"	87	79	104	243				
	100	205	130x1/4"	106	99	122	273				
	125	225	160x1/4"	132	119	135	273				

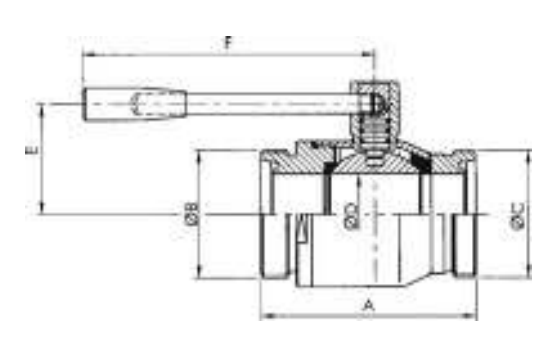
КРАН ШАРОВОЙ РЕЗЬБА-РЕЗЬБА	40530		РАЗМЕРЫ							
	DN	A	резьб DIN 405 B/C	D	E	F			кг	
	25	89	52x1/6"	24	44	146				
	32	113	58x1/6"	33	50	146				
	40	124	65x1/6"	40	64	185				
	50	134	78x1/6"	49,5	68	185				
	65	146	95x1/6"	65	95	243				
	80	179	110x1/4"	79	104	243				
	100	205	130x1/4"	99	122	273				
	125	225	160x1/4"	119	135	273				

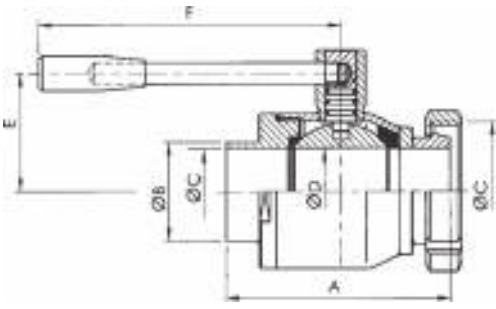
КРАН ШАРОВОЙ ГАЙКА-СВАРКА	40540		РАЗМЕРЫ									
	DN	A	B	резьб DIN 405 C	D	E	F					кг
	25	89	31	52x1/6"	24	44	146					
	32	120	37	58x1/6"	33	50	146					
	40	128	43	65x1/6"	40	64	185					
	50	140	55	78x1/6"	49,5	68	185					
	65	152	72	95x1/6"	65	95	243					
	80	190	87	110x1/4"	79	104	243					
	100	221	106	130x1/4"	99	122	273					
	125	259	132	160x1/4"	119	135	273					

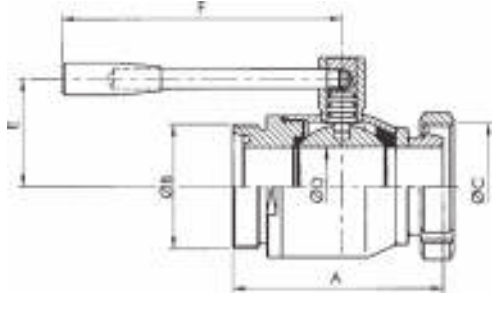
КРАН ШАРОВОЙ ГАЙКА-РЕЗЬБА	40550		РАЗМЕРЫ									
	DN	A	резьб DIN 405 B/C	D	E	F						кг
	25	92	52x1/6"	24	44	146						
	32	118	58x1/6"	33	50	146						
	40	128	65x1/6"	40	64	185						
	50	140	78x1/6"	49,5	68	185						
	65	152	95x1/6"	65	95	243						
	80	190	110x1/4"	79	104	243						
	100	221	130x1/4"	99	122	273						
	125	259	160x1/4"	119	135	273						

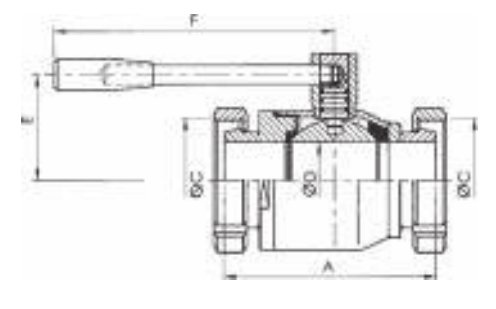
КРАН ШАРОВОЙ ГАЙКА-ГАЙКА	40560		РАЗМЕРЫ									
	DN	A	резьб DIN 405 C	D	E	F						кг
	25	92	52x1/6"	24	44	146						
	32	123	58x1/6"	33	50	146						
	40	131	65x1/6"	40	64	185						
	50	143	78x1/6"	49,5	68	185						
	65	160	95x1/6"	65	95	243						
	80	190	110x1/4"	79	104	243						
	100	235	130x1/4"	99	122	273						
	125	259	160x1/4"	119	135	273						

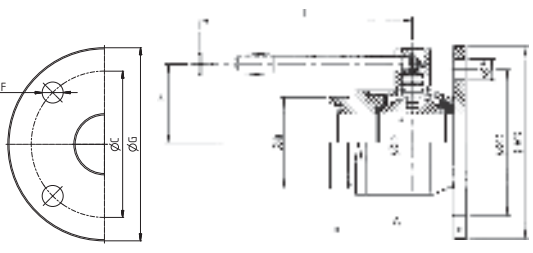
КРАН ШАРОВОЙ ШТУЦЕР-РЕЗЬБА	40570		РАЗМЕРЫ									
	DN	A	резьб DIN 405 B	C	D	E	F	G	L		кг	
	25	86	52x1/6"	85	24	44	14x4	115	146			
	32	104	58x1/6"	100	33	50	18x4	140	146			
	40	107	65x1/6"	110	40	64	18x4	150	185			
	50	117	78x1/6"	125	49,5	68	18x4	165	185			
	65	141	95x1/6"	145	65	95	18x4	185	243			
	80	156	110x1/4"	160	79	104	18x4	200	243			
	100	181	130x1/4"	180	99	122	18x8	220	273			
	125	201	160x1/4"	210	119	135	18x8	250	273			

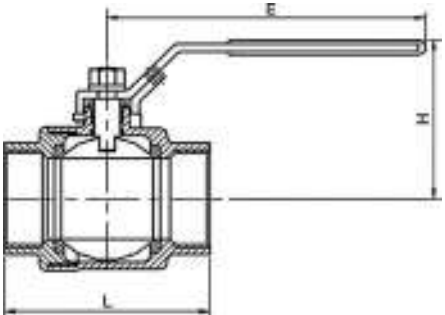
КРАН ШАРОВОЙ ИЗ ДВУХ ЧАСТЕЙ ВР-ВР	40640	РАЗМЕРЫ							
		DN	L	E	H				кг
	1/4"	52	90	55					
	3/8"	52	90	55					
	1/2"	55	105	55					
	3/4"	65	115	60					
	1"	72	120	70					
	1 1/4"	83	145	75					
	1 1/2"	95	175	90					
	2"	110	175	100					
	2 1/2"	144	210	130					
	3"	170	230	140					

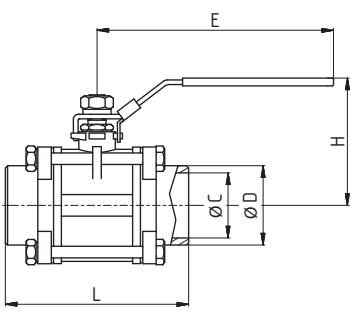
КРАН ШАРОВОЙ ИЗ ТРЕХ ЧАСТЕЙ СВАРКА-СВАРКА	40650	РАЗМЕРЫ						
		DN	L	E	H	C	D	кг
	8	63	95	46	11	17		
	10	63	95	50	12	17		
	15	75	103	56	15	21,3		
	20	80	118	66	20	26,7		
	25	90	135	72	25	33,4		
	32	110	135	83	32	42,2		
	40	120	160	88	38	48,3		
	50	140	173	100	50	60,3		
	65	165	216	127	65	74		
	80	202	232	138	80	91		
100	252	330	171	100	110			

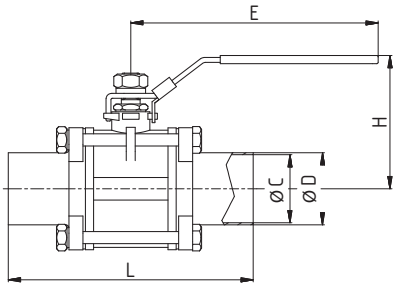
КРАН ШАРОВОЙ ИЗ ТРЕХ ЧАСТЕЙ СВАРКА-СВАРКА	40660	РАЗМЕРЫ						
		DN	L	E	H	C	D	кг
	10	100	95	50	10	13		
	15	125	103	56	16	19		
	20	130	118	66	20	23		
	25	140	135	72	26	29		
	32	168	135	83	32	35		
	40	178	160	88	38	41		
	50	200	173	100	50	53		
	65	245	216	127	66	70		
	80	282	232	138	81	85		
	100	332	330	171	100	104		

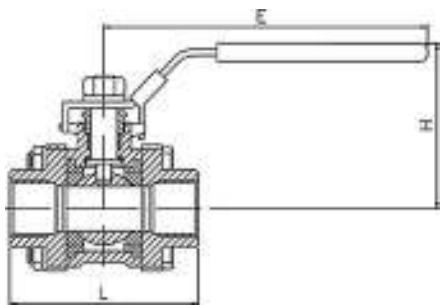
КРАН ШАРОВОЙ ИЗ ТРЕХ ЧАСТЕЙ ВР-ВР	40670	РАЗМЕРЫ							
		DN	L	E	H				кг
	1/4"	51	95	46					
	3/8"	65	95	50					
	1/2"	74	103	56					
	3/4"	70	118	66					
	1"	89	135	72					
	1 1/4"	108	135	83					
	1 1/2"	108	160	88					
	2"	140	173	100					
	2 1/2"	168	216	127					
	3"	190	232	138					
4"	240	330	171						

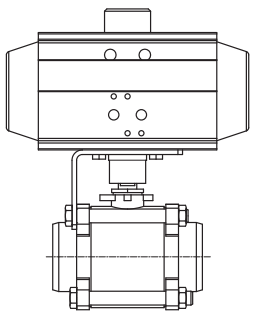
КРАН ШАРОВОЙ ИЗ ТРЕХ ЧАСТЕЙ СВАРКА-СВАРКА С ПНЕВМО- ПРИВОДОМ АТ (44050, 44100)	4065 P05	РАЗМЕРЫ							
	4065 P10	DN							кг
		10							
		15							
		20							
		25							
		32							
		40							
		50							
		65							
		80							
		100							

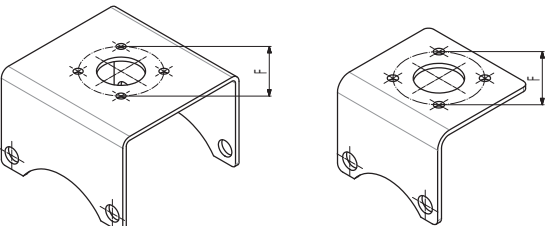
КРОНШТЕЙН ДЛЯ ПНЕВМОПРИВОДА	40770	РАЗМЕРЫ							
		DN							кг
		10	F04						
		15	F04						
		20	F04						
		25	F04						
		32	F04/F05						
		40	F05						
		50	F07						
		65	F07						
		80	F07						
		100	F07						

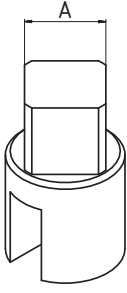
ПЕРЕХОДНИК	40780	РАЗМЕРЫ							
		A							кг
		11x11							
		14x14							
		17x17							
		22x22							

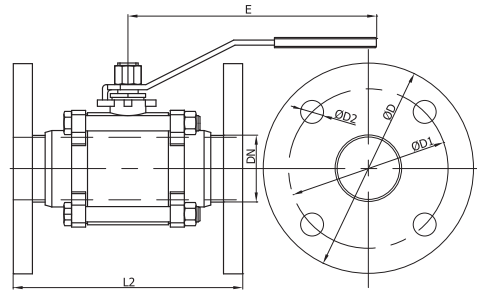
КРАН ШАРОВОЙ ИЗ ТРЕХ ЧАСТЕЙ ФЛАНЕЦ-ФЛАНЕЦ	4074 PN10 (20700)		РАЗМЕРЫ							
	DN	D	D1	D2	L2	E	H			кг
	25	115	85	14x4	162	135	72			
	32	140	100	18x4	186	135	83			
	40	150	110	18x4	200	160	88			
	50	165	125	18x4	226	173	100			
	65	185	145	18x4	251	216	127			
	80	200	160	18x8	301	232	138			
	100	220	180	18x8	351	330	171			

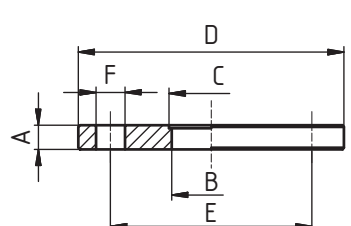
ФЛАНЕЦ ПН 10	20700 DIN 2576		РАЗМЕРЫ							
	DN	A	B	C	D	E	F			кг
	10	14	10	12,2	90	60	14x4			0,5
	15	14	16	18,2	95	65	14x4			0,6
	20	16	20	22,2	105	75	14x4			0,85
	25	16	26	28,2	115	85	14x4			1,11
	32	16	32	34,2	140	100	18x4			1,64
	40	16	38	40,2	150	110	18x4			1,8
	50	18	50	52,2	165	125	18x4			2,3
	65	18	66	70,3	185	145	18x4			2,88
	80	20	81	85,3	200	160	18x8			3,2
	100	20	100	104,3	220	180	18x8			4
125	22	125	129,5	250	210	18x8			5	
150	22	150	154,5	285	240	22x8			6,7	

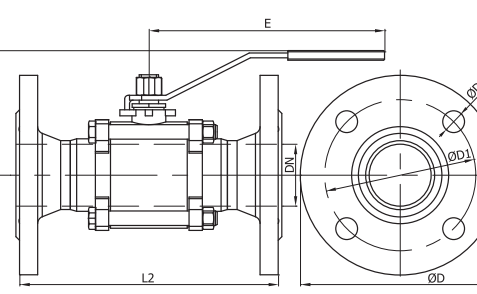
КРАН ШАРОВОЙ ИЗ ТРЕХ ЧАСТЕЙ ФЛАНЕЦ-ФЛАНЕЦ	4074 PN16 (20730)		РАЗМЕРЫ							
	DN	D	D1	D2	L2	E	H			кг
	25	115	85	14x4	162	135	72			
	32	140	100	18x4	186	135	83			
	40	150	110	18x4	200	160	88			
	50	165	125	18x4	226	173	100			
	65	185	145	18x4	251	216	127			
	80	200	160	18x8	301	232	138			
	100	220	180	18x8	351	330	171			

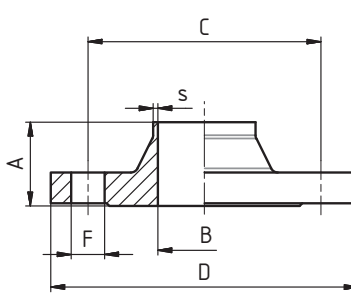
ФЛАНЕЦ ПН 16	20730		РАЗМЕРЫ							
	DN	A	B	C	D	F	s			кг
	10	35	10	60	90	14x4	1,5			0,58
	15	35	16	65	95	14x4	1,5			0,65
	20	38	20	75	105	14x4	1,5			0,95
	25	38	26	85	115	14x4	1,5			1,14
	32	40	32	100	140	18x4	1,5			1,6
	40	42	38	110	150	18x4	1,5			1,8
	50	45	50	125	165	18x4	1,5			2,53
	65	45	66	145	185	18x4	2			3,06
	80	50	81	160	200	18x8	2			3,7
	100	52	100	180	220	18x8	2			4,62
125	55	125	210	250	18x8	2			6,3	
150	55	150	240	285	22x8	2			7,75	

ЗАТВОР ДИСКОВЫЙ
СХЕМА СБОРКИ

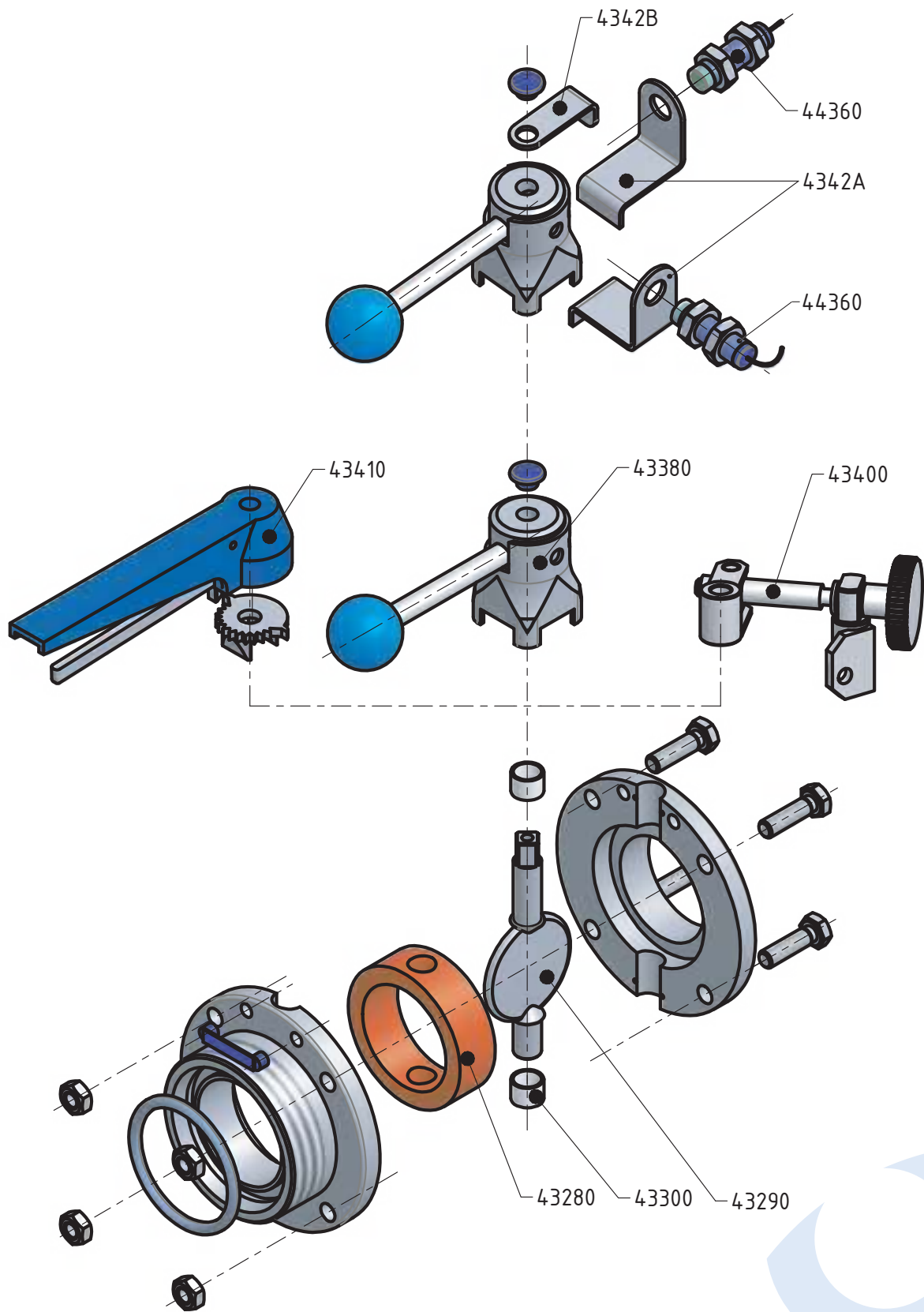

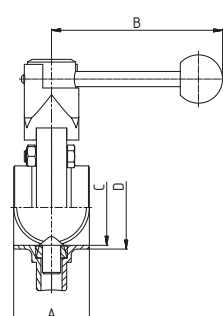
ЗАТВОР ДИСКОВЫЙ СВАРКА-СВАРКА	43010	РАЗМЕРЫ								
		DN	A	B	C	D				кг
	15	50	110	15	18					
	20	50	110	19	22					
	25	40	114	26	31					
	32	42	114	32	37					
	40	50	140	38	43					
	50	50	140	50	55					
	65	50	140	66	72					
	80	60	174	81	87					
	100	64	174	100	106					
	125	100	210	125	138					
150	100	210	150	164						

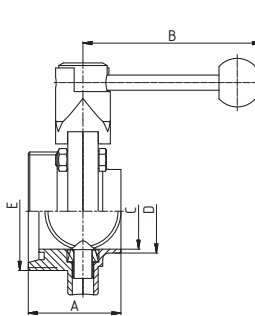
ЗАТВОР ДИСКОВЫЙ РЕЗЬБА-СВАРКА	43020	РАЗМЕРЫ								
		DN	A	B	C	D	резьб DIN 405 E			кг
	15	58	110	15	18	34x1/8"				
	20	58	110	19	22	44x1/6"				
	25	52	114	26	31	52x1/6"				
	32	53	114	32	37	58x1/6"				
	40	61	140	38	43	65x1/6"				
	50	61	140	50	55	78x1/6"				
	65	63	140	66	72	95x1/6"				
	80	80	174	81	87	110x1/4"				
	100	84	174	100	106	130x1/4"				
	125	106	210	125	138	160x1/4"				
150	112	210	150	164	190x1/4"					

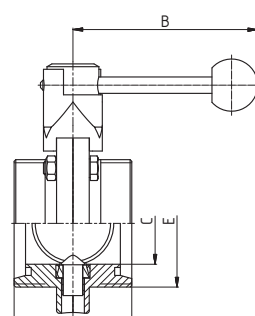
ЗАТВОР ДИСКОВЫЙ РЕЗЬБА-РЕЗЬБА	43030	РАЗМЕРЫ								
		DN	A	B	C	D	резьб DIN 405 E			кг
	15	66	110	15		34x1/8"				
	20	66	110	19		44x1/6"				
	25	64	114	26		52x1/6"				
	32	64	114	32		58x1/6"				
	40	72	140	38		65x1/6"				
	50	72	140	50		78x1/6"				
	65	76	140	66		95x1/6"				
	80	100	174	81		110x1/4"				
	100	104	174	100		130x1/4"				
	125	112	210	125		160x1/4"				
150	124	210	150		190x1/4"					

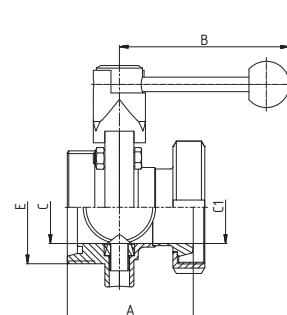
ЗАТВОР ДИСКОВЫЙ ГАЙКА-РЕЗЬБА	43040	РАЗМЕРЫ								
		DN	A	B	C	C1	резьб DIN 405 E			кг
	15	73	110	15	16	38x1/8"				
	20	74	110	19	20	44x1/6"				
	25	74	114	26	26	52x1/6"				
	32	78	114	32	32	58x1/6"				
	40	87	140	38	38	65x1/6"				
	50	89	140	50	50	78x1/6"				
	65	95	140	66	66	95x1/6"				
	80	117	174	81	81	110x1/4"				
	100	128	174	100	100	130x1/4"				
	125	138	210	125	125	160x1/4"				
150	147	210	150	150	190x1/4"					

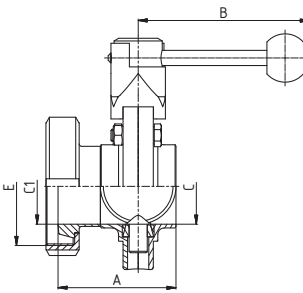
ЗАТВОР ДИСКОВЫЙ ГАЙКА-СВАРКА	43050		РАЗМЕРЫ								
	DN	A	B	C	C1	резьб E	DIN 405				кг
	15	65	110	15	16	34x1/8"					
	20	66	110	19	20	44x1/6"					
	25	60	114	26	26	52x1/6"					
	32	65	114	32	32	58x1/6"					
	40	74	140	38	38	65x1/6"					
	50	76	140	50	50	78x1/6"					
	65	80	140	66	66	95x1/6"					
	80	95	174	81	81	110x1/4"					
	100	106	174	100	100	130x1/4"					
	125	132	210	125	125	160x1/4"					
	150	135	210	150	150	190x1/4"					

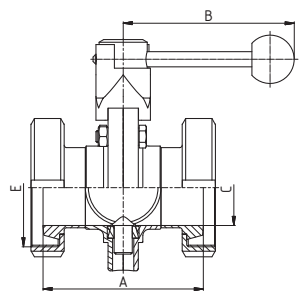
ЗАТВОР ДИСКОВЫЙ ГАЙКА-ГАЙКА	43060		РАЗМЕРЫ								
	DN	A	B	C	D	резьб E	DIN 405				кг
	15	80	110	16		38x1/8"					
	20	82	110	20		44x1/6"					
	25	80	114	26		52x1/6"					
	32	88	114	32		58x1/6"					
	40	98	140	38		65x1/6"					
	50	102	140	50		78x1/6"					
	65	110	140	66		95x1/6"					
	80	130	174	81		110x1/4"					
	100	148	174	100		130x1/4"					
	125	164	210	125		160x1/4"					
	150	170	210	150		190x1/4"					

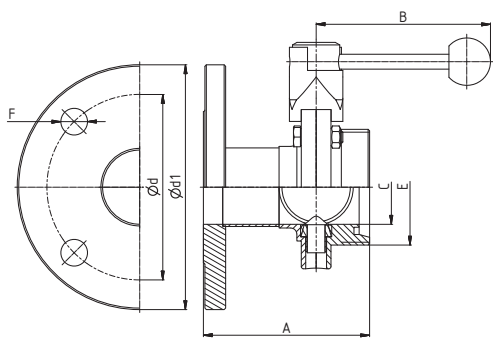
ЗАТВОР ДИСКОВЫЙ ФЛАНЕЦ-РЕЗЬБА	4307B		РАЗМЕРЫ										
	DN	A	B	C	резьб E	DIN 405	d	d1	F			кг	
	25	106	114	26	52x1/6"		85x4	115	14				
	32	106	114	32	58x1/6"		100x4	140	18				
	40	110	140	38	65x1/6"		110x4	150	18				
	50	112	140	50	78x1/6"		125x4	165	18				
	65	122	140	66	95x1/6"		145x4	185	18				
	80	135	174	81	110x1/4"		160x8	200	18				
	100	140	174	100	130x1/4"		180x8	220	18				

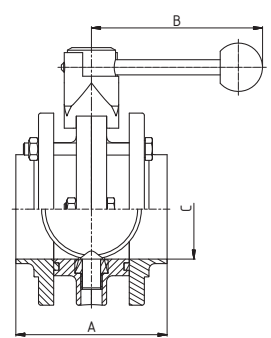
ЗАТВОР ДИСКОВЫЙ МЕЖФЛАНЦЕВЫЙ	43080		РАЗМЕРЫ									
	DN	A	B	C							кг	
	25	84	114	26								
	32	86	114	32								
	40	100	140	38								
	50	100	140	50								
	65	100	140	66								
	80	120	174	81								
	100	146	174	100								
	125	168	210	125								
	150	188	210	150								

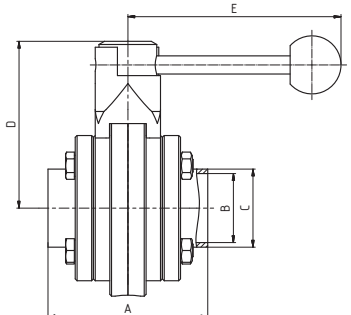
ЗАТВОР ДИСКОВЫЙ МЕЖФЛАНЦЕВЫЙ	43081	РАЗМЕРЫ									
		DN	A	B	C	D	E				
	25	78	26	31	87	117					
	32	78	32	37	90	117					
	40	88	38	43	92	126					
	50	88	50	53	98,5	126					
	65	88	66	72	107,5	126					
	80	120	81	87	120	153					
	100	124	100	106	130	153					
	125	140	125	132	160	205					
	150	160	150	157	175	205					

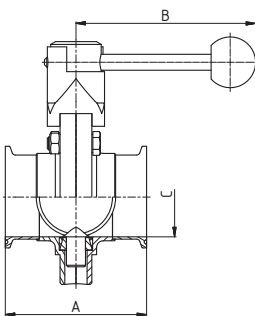
ЗАТВОР ДИСКОВЫЙ КЛАМП-КЛАМП	43090	РАЗМЕРЫ									
		DN	A	B	C						кг
	25	64	114	26							
	32	72	114	32							
	40	72	140	38							
	50	72	140	50							
	65	80	140	66							
	80	84	174	81							
	100	102	174	100							

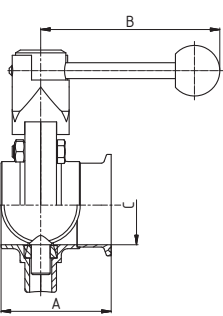
ЗАТВОР ДИСКОВЫЙ СВАРКА-КЛАМП	43101	РАЗМЕРЫ										
		DN	A	B	C	D	E	F	R	L	резьб DIN 405 Rd x s	кг
	25	59,5	114	26								1,3
	32	61,5	114	32								1,4
	40	69,5	140	38								1,6
	50	69,5	140	50								1,8
	65	76	140	66								2,2
	80	86	174	81								3,9
	100	90	174	100								4,6
	125	126	210	125								
	150	126	210	150								

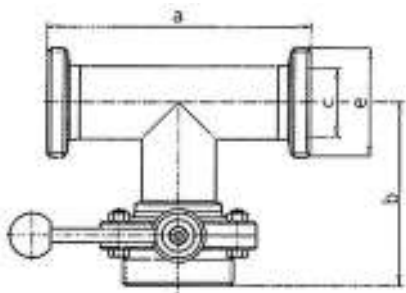
ЗАТВОР ТРЕХХОДОВОЙ РЕЗЬБА-РЕЗЬБА-РЕЗЬБА	43110	РАЗМЕРЫ									
		DN	A	B	C	резьб DIN 405 E					кг
	25	144	100	26	52x1/6"						
	32	154	106	32	58x1/6"						
	40	164	119	38	65x1/6"						
	50	186	127	50	78x1/6"						
	65	210	141	66	95x1/6"						
	80	230	168	81	110x1/4"						
	100	260	182	100	130x1/4"						
	125	446	291,5	125	160x1/4"						
	150	530	335	150	190x1/4"						

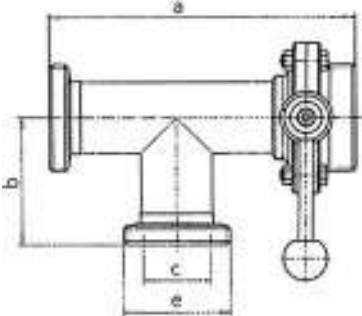
ЗАТВОР ТРЕХХОДОВОЙ РЕЗЬБА-РЕЗЬБА-РЕЗЬБА	43120	РАЗМЕРЫ										
		DN	A	B	C	резьб E	резьб DIN 405					кг
	25	172	72	26	52x1/6"							
	32	183	77	32	58x1/6"							
	40	201	82	38	65x1/6"							
	50	222	93	50	78x1/6"							
	65	146	105	66	95x1/6"							
	80	283	115	81	110x1/4"							
	100	312	130	100	130x1/4"							
	125	514,5	223	125	160x1/4"							
	150	600	265	150	190x1/4"							

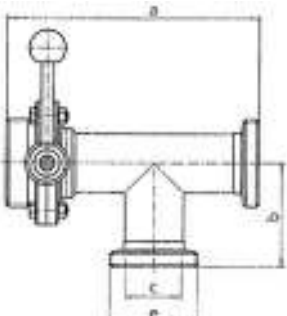
ЗАТВОР ТРЕХХОДОВОЙ РЕЗЬБА-РЕЗЬБА-РЕЗЬБА	43130	РАЗМЕРЫ										
		DN	A	B	C	резьб E	резьб DIN 405					кг
	25	172	72	26	52x1/6"							
	32	183	77	32	58x1/6"							
	40	201	82	38	65x1/6"							
	50	222	93	50	78x1/6"							
	65	146	105	66	95x1/6"							
	80	283	115	81	110x1/4"							
	100	312	130	100	130x1/4"							
	125	514,5	223	125	160x1/4"							
	150	600	265	150	190x1/4"							

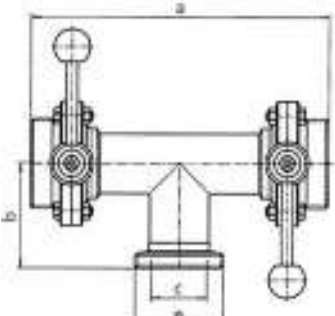
ЗАТВОР ТРЕХХОДОВОЙ 180° РЕЗЬБА-РЕЗЬБА-РЕЗЬБА	43140	РАЗМЕРЫ										
		DN	A	B	C	резьб E	резьб DIN 405					кг
	25	200	72	26	52x1/6"							
	32	212	77	32	58x1/6"							
	40	238	82	38	65x1/6"							
	50	258	93	50	78x1/6"							
	65	282	105	66	95x1/6"							
	80	336	115	81	110x1/4"							
	100	364	130	100	130x1/4"							
	125	583	223	125	160x1/4"							
	150	670	265	150	190x1/4"							

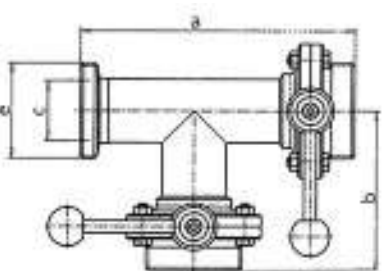
ЗАТВОР ТРЕХХОДОВОЙ ЛЕВЫЙ РЕЗЬБА-РЕЗЬБА-РЕЗЬБА	43150	РАЗМЕРЫ										
		DN	A	B	C	резьб E	резьб DIN 405					кг
	25	172	100	26	52x1/6"							
	32	183	106	32	58x1/6"							
	40	201	119	38	65x1/6"							
	50	222	127	50	78x1/6"							
	65	246	141	66	95x1/6"							
	80	283	168	81	110x1/4"							
	100	312	182	100	130x1/4"							
	125	514,5	291,5	125	160x1/4"							
	150	600	335	150	190x1/4"							

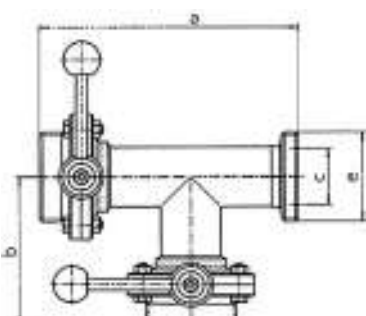
ЗАТВОР ТРЕХХОДОВОЙ 90° ПРАВЫЙ РЕЗЬБА-РЕЗЬБА-РЕЗЬБА	43160	РАЗМЕРЫ							
		DN	A	B	C	резьб E	DIN 405		кг
	25	172	100	26	52x1/6"				
	32	183	106	32	58x1/6"				
	40	201	119	38	65x1/6"				
	50	222	127	50	78x1/6"				
	65	246	141	66	95x1/6"				
	80	283	168	81	110x1/4"				
	100	312	182	100	130x1/4"				
	125	514,5	291,5	125	160x1/4"				
	150	600	335	150	190x1/4"				

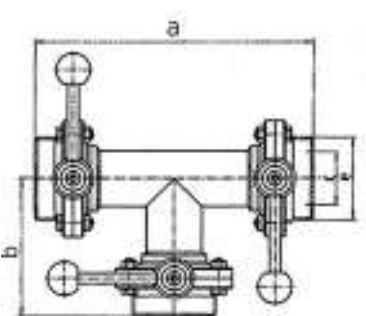
ЗАТВОР ТРЕХХОДОВОЙ С ТРЕМЯ ЗАТВОРАМИ РЕЗЬБА-РЕЗЬБА-РЕЗЬБА	43170	РАЗМЕРЫ							
		DN	A	B	C	резьб E	DIN 405		кг
	25	200	100	26	52x1/6"				1,34
	32	212	106	32	58x1/6"				1,39
	40	238	119	38	65x1/6"				1,56
	50	258	127	50	78x1/6"				1,76
	65	282	141	66	95x1/6"				2,24
	80	336	168	81	110x1/4"				3,91
	100	364	182	100	130x1/4"				4,56
	125	583	291,5	125	160x1/4"				
	150	670	335	150	190x1/4"				

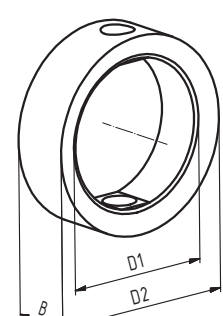
УПЛОТНЕНИЕ ДЛЯ ЗАТВОРА ДИСКОВОГО	43280	РАЗМЕРЫ							
		DN	D1	D2	B				кг
	25	26	40	20					
	32	32	48	20					
	40	38	54	21					
	50	51	67	21					
	65	67	85	22					
	80	82	101	24					
	100	101	116	26					
	125	125	151	29					
	150	150	175	29					

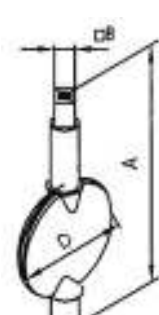
ДИСК ЗАТВОРА	43290	РАЗМЕРЫ							
		DN	A	B	C	D			кг
	25	80	9,5		26				0,05
	32	87,6	9,5		32				0,06
	40	93,6	9,5		38				0,10
	50	111	9,5		50				0,15
	65	128,1	9,5		66				0,24
	80	143,8	9,5		81				0,39
	100	163,9	9,5		100				0,63
	125	214	14,0		125				1,16
	150	245,8	14,0		150				2,00

ПОДШИПНИК ДИСКА ЗАТВОРА	43300	РАЗМЕРЫ							
		DN	D1	D2	L1				кг
		25	10	12	5				
		32	10	12	5				
		40	12	14	10				
		50	12	14	10				
		65	12	14	10				
		80	14	16	12				
		100	14	16	12				
		125	18	20	18				
		150	18	20	18				

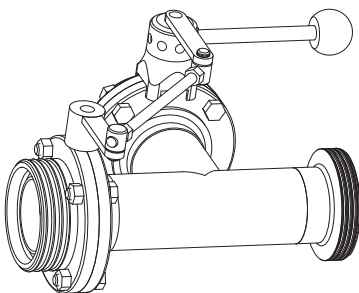
ЗАТВОР ТРЕХХОДОВОЙ 90° С ОБЩИМ РЫЧАГОМ УПРАВЛЕНИЯ, ЛЕВЫЙ РЕЗЬБА-РЕЗЬБА-РЕЗЬБА	43310	РАЗМЕРЫ							
		DN							кг
		25							
		32							
		40							
		50							
		65							
		80							
		100							
		125							
		150							

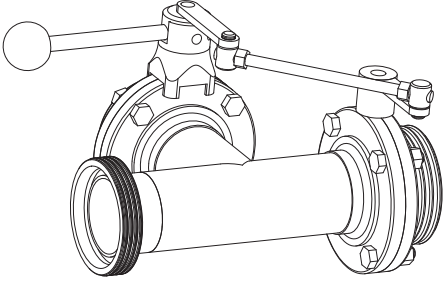
ЗАТВОР ТРЕХХОДОВОЙ 90° С ОБЩИМ РЫЧАГОМ УПРАВЛЕНИЯ, ПРАВЫЙ РЕЗЬБА-РЕЗЬБА-РЕЗЬБА	43320	РАЗМЕРЫ							
		DN							кг
		25							
		32							
		40							
		50							
		65							
		80							
		100							
		125							
		150							

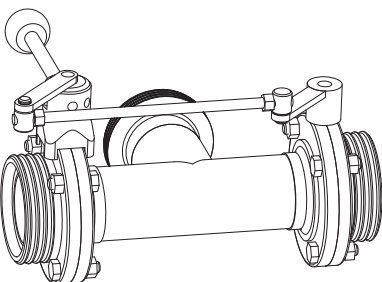
ЗАТВОР ТРЕХХОДОВОЙ 180° С ОБЩИМ РЫЧАГОМ УПРАВЛЕНИЯ, РЕЗЬБА-РЕЗЬБА-РЕЗЬБА	43330	РАЗМЕРЫ							
		DN							кг
		25							
		32							
		40							
		50							
		65							
		80							
		100							
		125							
		150							

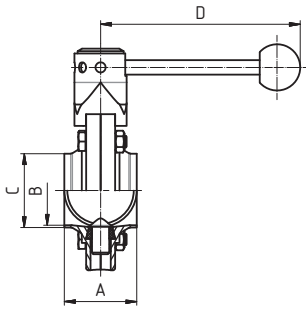
ЗАТВОР ДИСКОВЫЙ СВАРКА-СВАРКА	46010		РАЗМЕРЫ							
	SMS	DN	A	B	C	D				кг
		25	40	22	25	102,5				
		38	50	35	38	102,5				
		51	50	48	51	132,5				
		63,5	50	60,5	63,5	132,5				
		76,1	60	72,1	76,1	155				
		101,6	64	97,6	101,6	155				

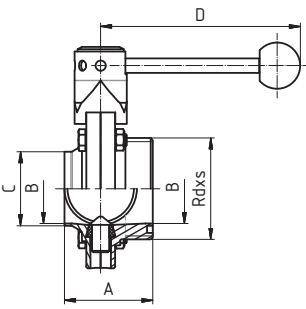
ЗАТВОР ДИСКОВЫЙ СВАРКА-РЕЗЬБА	46020		РАЗМЕРЫ						
	SMS	DN	A	B	C	D		резьб DIN 405 Rd x s	кг
		25	52	22	25	102,5		40x1/6"	
		38	61	35	38	102,5		60x1/6"	
		51	61	48	51	132,5		70x1/6"	
		63,5	63	60,5	63,5	132,5		85x1/6"	
		76,1	80	72,1	76,1	155		98x1/6"	
		101,6	84	97,6	101,6	155		125x1/4"	

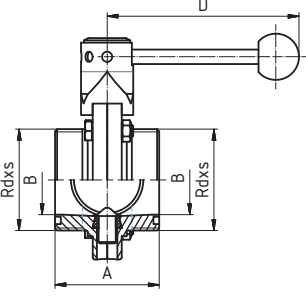
ЗАТВОР ДИСКОВЫЙ РЕЗЬБА-РЕЗЬБА	46030		РАЗМЕРЫ						
	SMS	DN	A	B	C	D		резьб DIN 405 Rd x s	кг
		25	64	22		102,5		40x1/6"	
		38	72	35		102,5		60x1/6"	
		51	72	48		132,5		70x1/6"	
		63,5	76	60,5		132,5		85x1/6"	
		76,1	100	72,1		155		98x1/6"	
		101,6	104	97,6		155		125x1/4"	

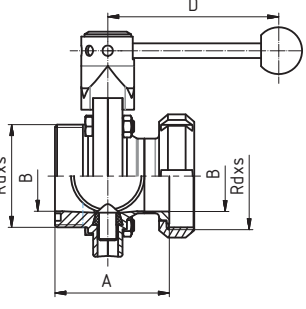
ЗАТВОР ДИСКОВЫЙ ГАЙКА-РЕЗЬБА	46040		РАЗМЕРЫ						
	SMS	DN	A	B	C	D		резьб DIN 405 Rd x s	кг
		25	67,5	22		102,5		40x1/6"	
		38	77	35		102,5		60x1/6"	
		51	78	48		132,5		70x1/6"	
		63,5	80	60,5		132,5		85x1/6"	
		76,1	99	72,1		155		98x1/6"	
		101,6	103	97,6		155		125x1/4"	

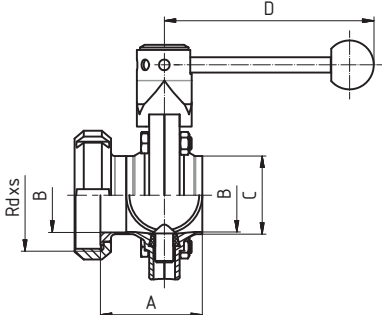
ЗАТВОР ДИСКОВЫЙ СВАРКА-ГАЙКА	46050		РАЗМЕРЫ										
	SMS		DN	A	B	C	D					резьб DIN 405 Rd x s	кг
	25	55,5	22	25	102,5							40x1/6"	
	38	66	35	38	102,5							60x1/6"	
	51	67	48	51	132,5							70x1/6"	
	63,5	67	60,5	63,5	132,5							85x1/6"	
	76,1	79	72,1	76,1	155							98x1/6"	
	101,6	83	97,6	101,6	155							125x1/4"	

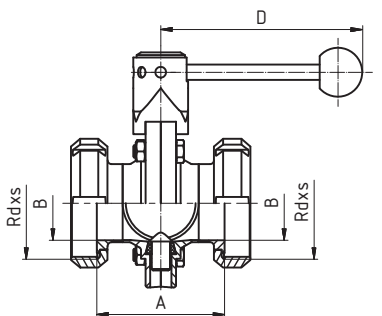
ЗАТВОР ДИСКОВЫЙ ГАЙКА-ГАЙКА	46060		РАЗМЕРЫ										
	SMS		DN	A	B	C	D	E	F	R	L	резьб DIN 405 Rd x s	кг
	25	55,5	22		102,5							40x1/6"	
	38	66	35		102,5							60x1/6"	
	51	67	48		132,5							70x1/6"	
	63,5	67	60,5		132,5							85x1/6"	
	76,1	79	72,1		155							98x1/6"	
	101,6	83	97,6		155							125x1/4"	

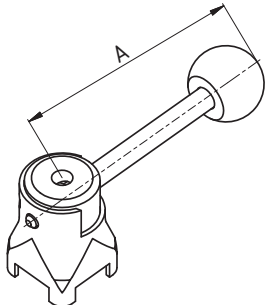
РУКОЯТКА ЗАТВОРА ТРЕХ- ПОЗИЦИОННАЯ С ФИКСАТОРОМ	43380		РАЗМЕРЫ										
			DN	A									кг
	25-40	114											
	50-65	140											
	80-100	174											
	125-150	210											

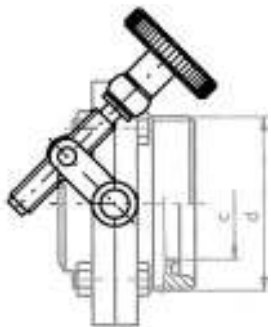
РУКОЯТКА ЗАТВОРА МИКРОМЕТРИЧЕСКАЯ	43400		РАЗМЕРЫ										
			DN										кг
	25												
	32												
	40												
	50												
	65												
	80												
	100												
	125												

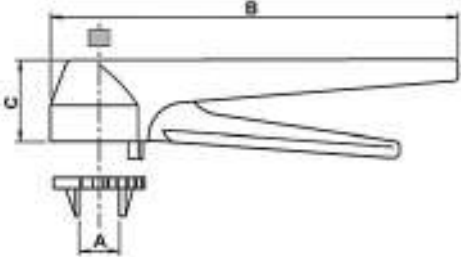
РУКОЯТКА ЗАТВОРА МНОГОПОЗИЦИОННАЯ	43410	РАЗМЕРЫ								
		DN	A	B	C					кг
		25-65	20,4	175	35					
		80-100	32,4	175	35					

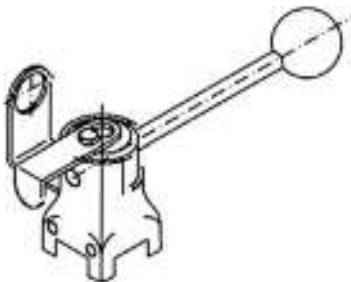
РУКОЯТКА ЗАТВОРА ПОД ДАТЧИК ПОЛОЖЕНИЯ	43420	РАЗМЕРЫ								
		DN								кг
		25-32								
		40-65								
		80-100								

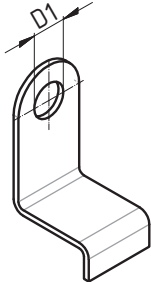
КРЕПЛЕНИЕ ДЛЯ ДАТЧИКА ПОЛОЖЕНИЯ	4342A	РАЗМЕРЫ								
		DN	D1							кг
		25-65	12							
		80-100	12							

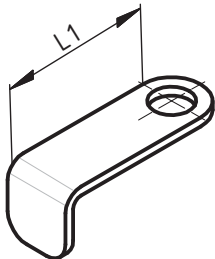
ПЕРЕКЛЮЧАТЕЛЬ ДЛЯ ДАТЧИКА ПОЛОЖЕНИЯ	4342B	РАЗМЕРЫ								
		DN	L1							кг
		25-100	42,5							

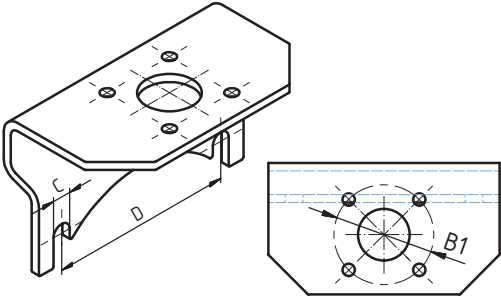
КРОНШТЕЙН ДЛЯ ПНЕВМОПРИВОДА 44050, 44100	43900	РАЗМЕРЫ								
		DN	B	B1	C	D				кг
	15	F04		7	47					
	20	F04		7	47					
	25	F03,F04	F04,F05	9	51,6					
	32	F03,F04	F04,F05	9	55,2					
	40	F04,F05		9	58,4					
	50	F05		9	67,6					
	65	F05		9	79,6					
	80	F05		9	90,2					
	100	F05		9	104,3					
	125	F07		9	90					
150	F07		9	105						

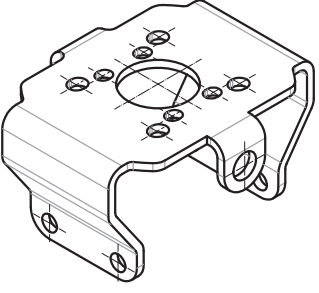
КРОНШТЕЙН ДЛЯ ПНЕВМОПРИВОДА 44050, 44100 К ЗАТВОРУ 43081	43906	РАЗМЕРЫ							
		DN	A						кг
	25-32	F05							
	40	F05							
	50-65	F05							
	80-100	F05-F07							

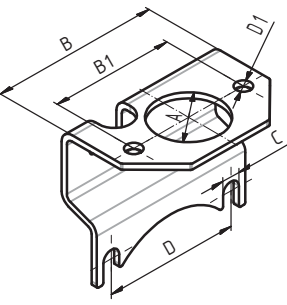
КРОНШТЕЙН ДЛЯ ПНЕВМОПРИВОДА 44200 ТИП D	43910	РАЗМЕРЫ							
		DN	A	B	B1	C	D	D1	
	25	35	78	62	9	51,6	8,2		
	32	35	82	62	9	55,2	8,2		
	40	35	86	62	9	58,4	8,2		
	50	35	84	62	9	67,6	8,2		
	65	35	106	62	9	79,6	8,2		
	80	35	116	62	9	90,2	8,2		
	100	35	131	62	9	104,3	8,2		
	125	35	120	62	11	90	10,2		

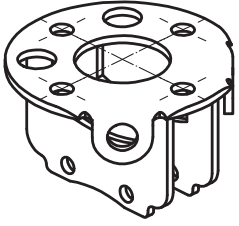
КРОНШТЕЙН ДЛЯ ПНЕВМОПРИВОДА 44200 ТИП С	43920	РАЗМЕРЫ							
		DN							кг
	25-65								
	80-100								

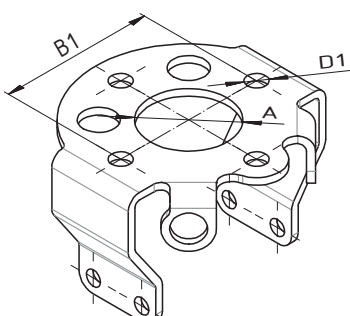
КРОНШТЕЙН ДЛЯ ПНЕВМОПРИВОДА 44200, 44150 К ЗАТВОРУ 43081	43926	РАЗМЕРЫ	
		DN	
		25-32	
		40	
		50-65	
		80-100	

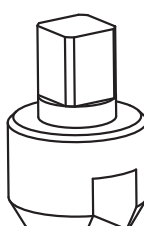
ПЕРЕХОДНИК	43940	РАЗМЕРЫ	
		DN	A
			9x9
			11x11
			14x14
			17x17
			22x22

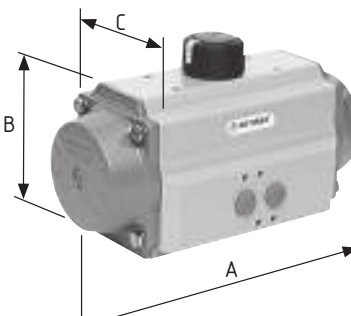
ПНЕВМАТИЧЕСКИЙ ПРИВОД ГОРИЗОНТАЛЬНЫЙ ОДИНАРНОГО ДЕЙСТВИЯ ВОЗДУХ-ПРУЖИНА	44050	РАЗМЕРЫ								
		DN	A	B	C	воздух 5 б р Мк	пружин Мк			кг
	SR 051	140,5	69	70,5		6,5 Н·м	6,0 Н·м			
	SR 101	158,5	85	83		11,2 Н·м	10,0 Н·м			
	SR 201	210,5	102	94,5		22,7 Н·м	20,3 Н·м			
	SR 251	247,5	115	106,3		33,3 Н·м	30,0 Н·м			
	SR 301	268,5	127	123		54,2 Н·м	48,6 Н·м			
	SR 401	345,0	145	141		117,0 Н·м	102,0 Н·м			

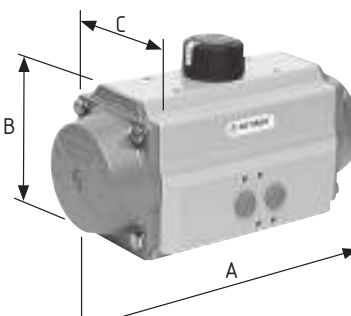
ПНЕВМАТИЧЕСКИЙ ПРИВОД ГОРИЗОНТАЛЬНЫЙ ДВОЙНОГО ДЕЙСТВИЯ ВОЗДУХ-ВОЗДУХ	44100	РАЗМЕРЫ								
		DN	A	B	C	воздух 5 б р Мк				кг
	DA 051	140,5	69	70,5		14,8 Н·м				
	DA 101	158,5	85	83		26,4 Н·м				
	DA 201	210,5	102	94,5		56,1 Н·м				
	DA 251	247,5	115	106,3		85,4 Н·м				
	DA 301	268,5	127	123		133,0 Н·м				
	DA 401	345,0	145	141		288,0 Н·м				

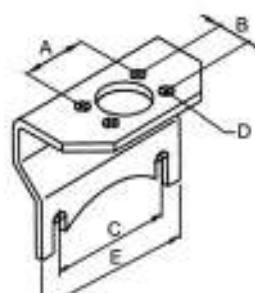
ДЕРЖАТЕЛЬ ПНЕВМОПРИВОДА	44140	РАЗМЕРЫ								
		DN	A	B	C	D	E		кг	
		25	30,3	17,6	51,6	6	78		0,2	
			32	30,3	17,6	55,2	6	82		0,3
			40	30,3	17,6	58,4	6	86		0,3

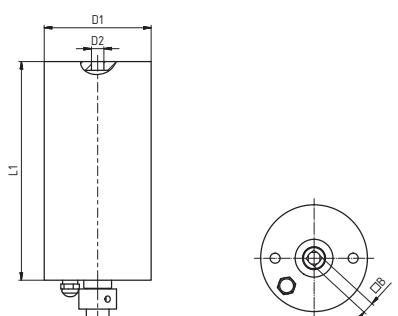
ПНЕВМОПРИВОД ВЕРТИКАЛЬНЫЙ ДВОЙНОГО ДЕЙСТВИЯ ВОЗДУХ-ВОЗДУХ	44150		РАЗМЕРЫ								
	ТИП	A	B	D1	D2	L1				Мк (Н·м)	кг
	85		9,5	85	1/8"	174				30	3,5
	101		9,5	101	1/8"	185				42	4,1
	120		14	120	1/8"	185				70	6,5
Время р боты (при 90°С): 1,5 сек Р бочее д вление воздух : 5-6 б р М ксим льное д вление воздух : 10 б р Р боч я темпер тур : 10-140°С											

ПНЕВМОПРИВОД ВЕРТИКАЛЬНЫЙ ОДИНАРНОГО ДЕЙСТВИЯ ВОЗДУХ-ПРУЖИНА	44200		РАЗМЕРЫ								
	ТИП	A	B	D1	D2	L1				Мк (Н·м)	кг
	85		9,5	85	1/8"	174				30	3,8
	101		9,5	101	1/8"	185				42	4,5
	120		14	120	1/8"	185				70	6,5
Время р боты (при 90°С): 1,5 сек Р бочее д вление воздух : 5-6 б р М ксим льное д вление воздух : 10 б р Р боч я темпер тур : 10-140°С											

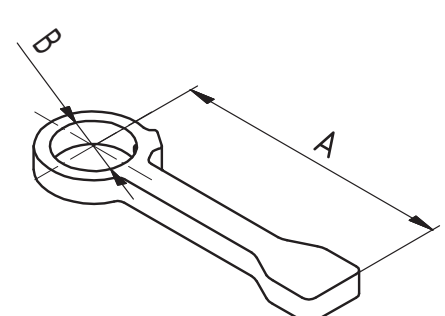
ПЕРЕКЛЮЧАТЕЛЬ	44221		РАЗМЕРЫ								
	DN	A	B								кг
	25-100	72	18,3								

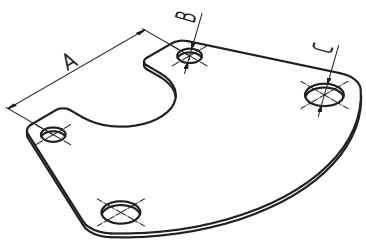
ДЕРЖАТЕЛЬ ДАТЧИКА ПОЛОЖЕНИЯ	44231		РАЗМЕРЫ								
	DN	A	B	C							кг
	25-100	62	8	12,5							
	100-150	62	8	12,5							

СОЛЕНОИДНЫЙ КЛАПАН 3/2	44270	ХАРАКТЕРИСТИКИ				
		Входной р зъем	G 1/8"			
		Номин льный ди метр	1,3 мм			
		Р бочее д вление	0-10 б р			
		Р боч я темпер тур	-10...70 °С			
		Кл сс з щиты	PI 65 – DIN 40050			
		Н пряжение	24 В АС	24 В DC	230 В АС	
		Потребляем я мощность	5 ВА	3 Вт	5 ВА	
		Пропускн я способность	50 л/мин			
		<p>ОПИСАНИЕ</p> <p>Электром гнитный кл п н прямого действия 3/2</p> <p>Все р зъемы G 1/8»</p> <p>Сброс пружины</p> <p>Корпус люминиевый нодиров нный, с миним льными внешними р змер ми</p> <p>Поршень из нерж веющей ст ли 1.4305</p> <p>Уплотнения NBR</p> <p>Винты из нерж веющей ст ли 1.4301</p>				

СОЛЕНОИДНЫЙ КЛАПАН ТИП NAMUR 5/2	44300	ХАРАКТЕРИСТИКИ				
		Входной р зъем	G 1/4"			
		Номин льный ди метр	5,5 мм			
		Р бочее д вление	2-10 б р			
		Р боч я темпер тур	-10...50 °С			
		Кл сс з щиты	IP 65 – DIN 40050			
		Н пряжение	24 В АС	24 В DC	230 В АС	
		Потребляем я мощность	5 ВА	3 Вт	5 ВА	
		Пропускн я способность	950 л/мин			
		<p>ОПИСАНИЕ</p> <p>Электром гнитный кл п н тип NAMUR комбиниров нный 5/2 – 3/2, со ст нд ртной к тушкой и р зъемом</p> <p>Легкое переключение с 5/2 н 3/2 с помощью иннов ционного поворотного уплотнения</p> <p>Пневм тический сброс пружины</p> <p>Ав рийный ручной привод в ст нд ртной комплект ции</p> <p>Корпус люминиевый нодиров нный, с миним льными внешними р змер ми</p> <p>Переходн я пл стин NAMUR PA6 – 30% стекловолокно</p> <p>Поршень из нерж веющей ст ли 1.4305</p> <p>Уплотнения NBR</p> <p>Винты из нерж веющей ст ли 1.4301</p>				

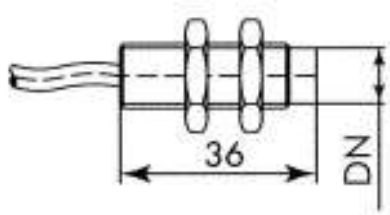
ДАТЧИК ПОЛОЖЕНИЯ ИНДУКТИВНЫЙ	44360	РАЗМЕРЫ										
		DN										кг
		M 8x1										
		M 12x1										

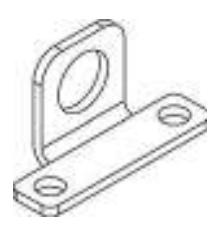
ДЕРЖАТЕЛЬ ДАТЧИКА ПОЛОЖЕНИЯ	44370	РАЗМЕРЫ										
		DN										кг
												

ГЛУШИТЕЛЬ	44420	РАЗМЕРЫ										
		DN	G	L								кг
		G 1/8	G 1/8"	21,5								
		G 1/4	G 1/4"	26,5								

ШТУЦЕР СОЕДИНИТЕЛЬНЫЙ	44430	РАЗМЕРЫ										
		DN	C	D								кг
		G 1/8 - 4	G 1/8"	4								
		G 1/8 - 6	G 1/8"	6								
		G 1/8 - 8	G 1/8"	8								
		G 1/8 - 10	G 1/8"	10								
		G 1/4 - 4	G 1/4"	4								
		G 1/4 - 6	G 1/4"	6								
		G 1/4 - 8	G 1/4"	8								
		G 1/4 - 10	G 1/4"	10								
		G 1/4 - 12	G 1/4"	12								

ШТУЦЕР 90°	44435	РАЗМЕРЫ									
		DN	G	D							кг
			G1/8	D 4							
			G1/8	D 6							
			G1/8	D 8							
			G1/4	D 4							
			G1/4	D 6							
			G1/4	D 8							

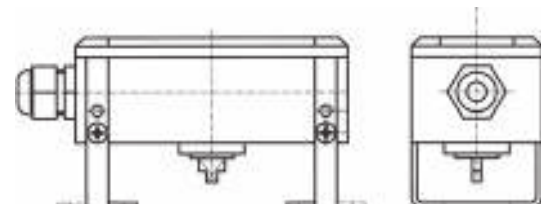
ДАТЧИК ПОЛОЖЕНИЯ	44450	РАЗМЕРЫ									
		DN									кг
											

НИППЕЛЬ ВНЕШНИЙ НР-НР	44500	РАЗМЕРЫ									
		DN	G1	G2							кг
		1/4-1/4	G 1/4"	G 1/4"							
		1/4-1/8	G 1/4"	G 1/8"							
		1/8-1/8	G 1/8"	G 1/8"							
		3/8-3/8	G 3/8"	G 3/8"							

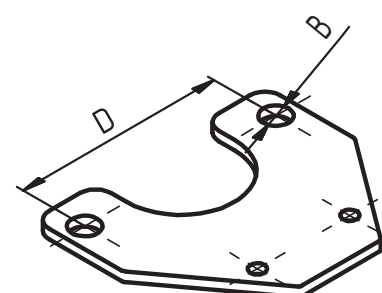
ДЕРЖАТЕЛЬ ДАТЧИКА ПОЛОЖЕНИЯ К ЭЛЕКТРОПРИВОДУ	44511	РАЗМЕРЫ									
		DN	A	B	C	D					кг
		25 - 100		8,2		62					

ПОВОРОТНЫЙ ВЫКЛЮЧАТЕЛЬ	44521	ХАРАКТЕРИСТИКИ
		
<p>44521 А –  для 44530</p> <p>44521 В –  для 44360</p>		

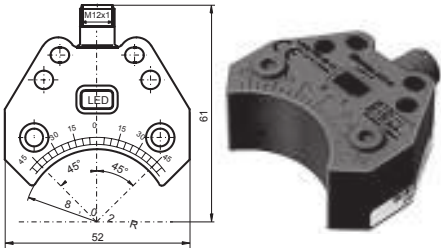
ИНДУКТИВНЫЙ ДАТЧИК ПОЛОЖЕНИЯ	44530	ХАРАКТЕРИСТИКИ																																												
																																														
<table border="1" style="width: 100%; border-collapse: collapse;"> <tr> <td colspan="2">Основные характеристики</td> <td>3 щит от переполосовки</td> <td>все конт кты</td> </tr> <tr> <td>Функция переключателя</td> <td>PNP Dual NO</td> <td>3 щит от КЗ</td> <td>импульсная</td> </tr> <tr> <td>Номинальная длительность срабатывания</td> <td>3 мм</td> <td>Падение напряжения</td> <td>≤ 3 В</td> </tr> <tr> <td>Установка</td> <td>скрытое крепление</td> <td>Ток в состоянии «включен»</td> <td>0-200 мА</td> </tr> <tr> <td>Тип выходного тока</td> <td>DC</td> <td>Ток в состоянии «выключен»</td> <td>0-0,5 мА (тип. 0,1 мкА при 25 °С)</td> </tr> <tr> <td>Граничная длительность срабатывания</td> <td>0-2,43 мм</td> <td>Ток в режиме ожидания</td> <td>≤ 25 мА</td> </tr> <tr> <td colspan="2">Технические характеристики</td> <td>Индикация питания</td> <td>LED, зеленый</td> </tr> <tr> <td>Рабочее напряжение</td> <td>10-30 В DC</td> <td>Индикация срабатывания</td> <td>LED, желтый</td> </tr> <tr> <td>Частота переключения</td> <td>0-500 Гц</td> <td colspan="2">Условия окружающей среды</td> </tr> <tr> <td>Гистерезис</td> <td>тип. 5 %</td> <td>Рабочая температура</td> <td>-25...70 °С</td> </tr> <tr> <td></td> <td></td> <td>Температура хранения</td> <td>-40...85 °С</td> </tr> </table>			Основные характеристики		3 щит от переполосовки	все конт кты	Функция переключателя	PNP Dual NO	3 щит от КЗ	импульсная	Номинальная длительность срабатывания	3 мм	Падение напряжения	≤ 3 В	Установка	скрытое крепление	Ток в состоянии «включен»	0-200 мА	Тип выходного тока	DC	Ток в состоянии «выключен»	0-0,5 мА (тип. 0,1 мкА при 25 °С)	Граничная длительность срабатывания	0-2,43 мм	Ток в режиме ожидания	≤ 25 мА	Технические характеристики		Индикация питания	LED, зеленый	Рабочее напряжение	10-30 В DC	Индикация срабатывания	LED, желтый	Частота переключения	0-500 Гц	Условия окружающей среды		Гистерезис	тип. 5 %	Рабочая температура	-25...70 °С			Температура хранения	-40...85 °С
Основные характеристики		3 щит от переполосовки	все конт кты																																											
Функция переключателя	PNP Dual NO	3 щит от КЗ	импульсная																																											
Номинальная длительность срабатывания	3 мм	Падение напряжения	≤ 3 В																																											
Установка	скрытое крепление	Ток в состоянии «включен»	0-200 мА																																											
Тип выходного тока	DC	Ток в состоянии «выключен»	0-0,5 мА (тип. 0,1 мкА при 25 °С)																																											
Граничная длительность срабатывания	0-2,43 мм	Ток в режиме ожидания	≤ 25 мА																																											
Технические характеристики		Индикация питания	LED, зеленый																																											
Рабочее напряжение	10-30 В DC	Индикация срабатывания	LED, желтый																																											
Частота переключения	0-500 Гц	Условия окружающей среды																																												
Гистерезис	тип. 5 %	Рабочая температура	-25...70 °С																																											
		Температура хранения	-40...85 °С																																											

КАБЕЛЬНЫЙ РАЗЪЕМ 90°	44540	ХАРАКТЕРИСТИКИ																						
																								
<table border="1" style="width: 100%; border-collapse: collapse;"> <tr> <td colspan="2">Основные характеристики</td> </tr> <tr> <td>Число контактов</td> <td>4</td> </tr> <tr> <td>Конструкция</td> <td>угловой разъем</td> </tr> <tr> <td colspan="2">Электрические характеристики</td> </tr> <tr> <td>Рабочее напряжение</td> <td>м.к.с. 60 В DC</td> </tr> <tr> <td>Рабочий ток</td> <td>м.к.с. 4 А</td> </tr> <tr> <td>Объемное сопротивление</td> <td>< 5 МОм</td> </tr> <tr> <td colspan="2">Условия окружающей среды</td> </tr> <tr> <td>Рабочая температура подвижное соединение</td> <td>-5...70 °С</td> </tr> <tr> <td>Рабочая температура неподвижное соединение</td> <td>-30...80 °С</td> </tr> <tr> <td>Степень токопроводящего загрязнения</td> <td>3</td> </tr> </table>			Основные характеристики		Число контактов	4	Конструкция	угловой разъем	Электрические характеристики		Рабочее напряжение	м.к.с. 60 В DC	Рабочий ток	м.к.с. 4 А	Объемное сопротивление	< 5 МОм	Условия окружающей среды		Рабочая температура подвижное соединение	-5...70 °С	Рабочая температура неподвижное соединение	-30...80 °С	Степень токопроводящего загрязнения	3
Основные характеристики																								
Число контактов	4																							
Конструкция	угловой разъем																							
Электрические характеристики																								
Рабочее напряжение	м.к.с. 60 В DC																							
Рабочий ток	м.к.с. 4 А																							
Объемное сопротивление	< 5 МОм																							
Условия окружающей среды																								
Рабочая температура подвижное соединение	-5...70 °С																							
Рабочая температура неподвижное соединение	-30...80 °С																							
Степень токопроводящего загрязнения	3																							

КАБЕЛЬНЫЙ РАЗЪЕМ ПРЯМОЙ	44541	ХАРАКТЕРИСТИКИ																								
																										
<table border="1" style="width: 100%; border-collapse: collapse;"> <tr> <td colspan="2">Основные характеристики</td> </tr> <tr> <td>Число контактов</td> <td>4</td> </tr> <tr> <td>Конструкция</td> <td>прямой разъем «м.м.», резьба М12 / шлейф</td> </tr> <tr> <td colspan="2">Электрические характеристики</td> </tr> <tr> <td>Рабочее напряжение</td> <td>м.к.с. 250 В AC/DC</td> </tr> <tr> <td>Рабочий ток</td> <td>м.к.с. 4 А</td> </tr> <tr> <td>Объемное сопротивление</td> <td>< 5 МОм</td> </tr> <tr> <td colspan="2">Условия окружающей среды</td> </tr> <tr> <td>Рабочая температура, корпус</td> <td>-40...90 °С</td> </tr> <tr> <td>Шлейф, подвижное соединение</td> <td>-5...70 °С</td> </tr> <tr> <td>Шлейф, неподвижное соединение</td> <td>-30...80 °С</td> </tr> <tr> <td>Степень токопроводящего загрязнения</td> <td>3</td> </tr> </table>			Основные характеристики		Число контактов	4	Конструкция	прямой разъем «м.м.», резьба М12 / шлейф	Электрические характеристики		Рабочее напряжение	м.к.с. 250 В AC/DC	Рабочий ток	м.к.с. 4 А	Объемное сопротивление	< 5 МОм	Условия окружающей среды		Рабочая температура, корпус	-40...90 °С	Шлейф, подвижное соединение	-5...70 °С	Шлейф, неподвижное соединение	-30...80 °С	Степень токопроводящего загрязнения	3
Основные характеристики																										
Число контактов	4																									
Конструкция	прямой разъем «м.м.», резьба М12 / шлейф																									
Электрические характеристики																										
Рабочее напряжение	м.к.с. 250 В AC/DC																									
Рабочий ток	м.к.с. 4 А																									
Объемное сопротивление	< 5 МОм																									
Условия окружающей среды																										
Рабочая температура, корпус	-40...90 °С																									
Шлейф, подвижное соединение	-5...70 °С																									
Шлейф, неподвижное соединение	-30...80 °С																									
Степень токопроводящего загрязнения	3																									

ЭЛЕКТРОПРИВОД	44590	ХАРАКТЕРИСТИКИ								
		Максимальный крутящий момент, Н·м	Тип	Переключатель вкл / выкл	Переключатель позиционер	Время р. боты при 90 °С, сек	Фл. нец ISO	Мощность, кВт	Р. бочий ток, А	Ст. ртовый ток, А
85-260 В AC 50-60 Гц										
		70	AQ7L	Yes	Yes	15	F05/F07	0.02	0.4	1
24 В DC										
		70	AQ7L	Yes	Yes	15	F05/F07	0.02	0.5	6

БЛОК УПРАВЛЕНИЯ СО СВЕТОДИОДНОЙ ИНДИКАЦИЕЙ	44710-С3	ХАРАКТЕРИСТИКИ									
		44710 С3 ЕКО	основная пластин POM механический концевой выключатель (2 позиции) мгнитный клапан 24 В DC индикатор положения – LED (зеленый/красный)								
		44710 С3 STANDART	основная пластин POM индукционный датчик (2 позиции) мгнитный клапан 24 В DC индикатор положения – LED (зеленый/красный)								
		44710 С3 МАХ	основная пластин AISI 304 индукционный датчик (2 позиции) мгнитный клапан 24 В DC индикатор положения – LED (зеленый/красный)								

ЦИФРОВОЙ ЭЛЕКТРОПНЕВМАТИЧЕСКИЙ РЕГУЛЯТОР ПОЛОЖЕНИЯ	44800	ХАРАКТЕРИСТИКИ	
		Материал корпуса	Алюминий с полимерным покрытием
		Материал уплотнения	EPDM, NBR, FKM
		Р. бочее напряжение	24 В DC ±10%
		Упр. точность пульсации	10%, не техническое выпрямленное напряжение!
		Управляющий сигнал	0/4...20 мА и 0...5/10 В
		Сопротивление входе	0/4...20 мА: 180 Ом 0...5/10 В: 19 кОм
		Аналоговый выходной сигнал	4-20 мА, 0-20 мА 0-10 В, 0-5 В
		Бинарный вход	Сигнал с логическим разделением, 0-5 В = лог «0», 10-30 В = лог «1»
		Бинарные выходы	2 выхода (опция), сигнал с логическим разделением
		Ограничение тока	100 мА, при перегрузке выход синхронизируется
		Р. бочья среда	Нейтральные газы, воздух по DIN ISO 8573-1
		Содержание пыли	Класс 5 (р. змер ч. стиц < 40 мкм)
		Плотность ч. стиц	Класс 5 (< 10 мг/м³)
		Точка росы сжатого воздуха	Класс 3 (< -20 °C)
		Концентрация масла	Класс 5 (< 25 мг/м³)
		Температура окружающей среды	0...60 °C
		Подключение сжатого воздуха	Резьба G 1/4
		Р. бочее давление	1,4...7 бар*
		Фильтр приточного воздуха	Сменный (р. змер ячеек ~ 0,1 мм)
		Система регулирования	Простого и двойного действия до 150 л/мин
		Производительность	95 л/мин (при 1,4 бар**) для подчи и сброс воздуха, 150 л/мин (при 6 бар**) для подчи и сброс воздуха, 100 л/мин (по определению при сбросе бс. двления с 7 до 6 бар)
		Модуль определения положения	Потенциометр, макс. угол 180°
		Длина хода стержня клапана	Минимум 30° поворотом в луг, зависит от рычага
		Положение при монтаже	Любое, дисплей сверху или сбоку
		Класс защиты	IP 65/67 по EN 60529 (NEMA4х – в зр. ботке)
		Потребляемая мощность	< 5 Вт
		Электроподключение:	
		мультиполюсный р. зьем	M12, 8-пол./4-пол.; M8, 4-пол.
		кбельный ввод	2xM20x1,5 (к. бель Ø10 мм) и винтовых зжим х (0,14-1,5 мм²)
		Связь с интерфейсом Bus	Profibus DPV1 (опция)
		Индуктивный датчик приближения	По зпросу
		Класс защиты	3 по VDE 0580
		Зщит от возгорания	II 3 G nA II В Т4 (в зр. ботке) II 3 D tD A22 T135° (в зр. ботке)
		Соответствие нормам	EMV2004/108/EG
		Р. зрешения	CSA (в зр. ботке)
		* Двление входе в позиционер должно быть н 0,5-1 бар выше минимального управляющего двления для приводов.	
		** Избыточное двление относительно атмосферного.	
<p>Компактный регулятор положения сконструирован для установки на новые и подъемные и поворотные приводы в соответствии со стандартами IEC 534-6 и VDI/VDE 3845.</p> <p>Вариант с внешним датчиком измерения перемещений может использоваться для регулирующих клапанов Bürkert.</p> <p>Цифровой электропневматический позиционер SideControl образует все основные стандартные сигналы тока и напряжения, по запросу он может оснащаться интерфейсом PROFIBUS DPV1. Наряду с цифровой индикацией открытия клапана отображается при помощи механического индикатора.</p> <p>Управление осуществляется с помощью внешнего модуля с графическим дисплеем с подсветкой и пленочной клавиатурой с четырьмя кнопками. Прибор очень прост в обслуживании и эксплуатации (идентичен регулятору положения и процессов TopControl 8692/8693).</p> <p>Позиционер может использоваться одновременно как для приводов простого, так и двойного действия. Он отличается высокой надежностью при отключении подчиненного электрического или пневматического сигналов и имеет встроенные пилотные клапаны высокой производительности, способные работать с давлением до 7 бар.</p>			

<p>ЦИФРОВОЙ ЭЛЕКТРОПНЕВМАТИЧЕСКИЙ ПОЗИЦИОНЕР ДЛЯ УСТАНОВКИ НА РЕГУЛИРУЮЩИХ КЛАПАНАХ</p> 	<p>44801</p>	<p>ХАРАКТЕРИСТИКИ</p>	
		<p>Материал корпуса</p> <p>Материал крышки</p> <p>Материал уплотнения</p> <p>Напряжение</p> <p>Остаточная пульсация</p> <p>Управляющий сигнал</p> <p>Выходное сопротивление</p> <p>Рабочая среда</p> <p>Содержание пыли</p> <p>Плотность частиц</p> <p>Точка росы сжатого воздуха</p> <p>Концентрация масла</p> <p>Температура окружающей среды</p> <p>Подключение сжатого воздуха</p> <p>Рабочее давление</p> <p>Фильтр подчи воздуха</p> <p>Привод серии ELEMENT 23XX</p> <p>Привод серии CLASSIC 27XX</p> <p>Модуль определения положения</p> <p>Длина хода стержня клапана</p> <p>Установка</p> <p>Класс защиты</p> <p>Потребляемая мощность</p> <p>Электроподключение:</p> <p>Коммуникационные шины</p> <p>Класс защиты</p> <p>Соответствие нормам</p>	<p>PPS, нержавеющая сталь</p> <p>PC</p> <p>EPDM</p> <p>24 В DC ±10%</p> <p>Максимум 10%</p> <p>От 0/4 до 20 мА и от 0 до 5/10 В</p> <p>От 0/4 до 20 мА: 180 Ом От 0 до 5/10 В: 19 Ом</p> <p>Нейтральные газы, воздух DIN ISO 8573-1</p> <p>Класс 5 (р-мер частиц < 40 мкм)</p> <p>Класс 5 (< 10 мг/м³)</p> <p>Класс 3 (< -20 °C)</p> <p>Класс 5 (< 25 мг/м³)</p> <p>От 0 до +55°C</p> <p>Резьбовое присоединение G 1/8, нержавеющая сталь или латунные коннекторы (Ø6мм и 1/4" трубка)</p> <p>Рабочее давление: низкого давления от 0 до 7 бар* Рабочее давление: высокого давления от 3 до 7 бар</p> <p>Сменный (ячеич) фильтр ~ 0,1 мм)</p> <p>Рабочее давление: низкого давления: Ø привод 70/90 мм Рабочее давление: высокого давления: Ø привод 130 мм</p> <p>Рабочее давление: низкого давления: Ø привод 80/100 мм Рабочее давление: высокого давления: Ø привод 125/175/225 мм</p> <p>Бесконтактный, неизменяемый</p> <p>От 3 до 45 мм</p> <p>По необходимости, предпочтительно приводом вверх</p> <p>IP65 и IP67 согласно EN 60529</p> <p>< 5 Вт</p> <p>M12, 8-пол. или 4-пол. 2xM16x1,5 (к резьбе Ø10 мм) и винтовых зажимов (1,5 мм²)</p> <p>Profibus DPV1, DeviceNet</p> <p>3 согласно VDE 0580</p> <p>CE согласно EMV2004/108/EG</p>
<p>Компактный позиционер тип 8692 с улучшенной конструкцией для установки на пневмоприводы регулируемых клапанов тип 23XX/2103, отвечающий требованиям гигиенического исполнения оборудования.</p> <p>Кнопка подчи воздуха встроен в привод без использования внешних трубок. При помощи графического дисплея с подсветкой и клавиатуры или интерфейс ПК очень просто использовать и выбирать дополнительные функции ПО.</p> <p>Позиционер определяет положение клапана при помощи неограниченного бесконтактного датчика, не подверженного износу. Управление приводом много или двойного действия осуществляется без внутреннего сжатого воздуха. Также могут быть использованы коммуникационные шины, такие как Profibus DPV1 или DeviceNet, неограниченные устройств и устройств с двоичной обратной связью.</p> <p>Корпус легко чистить, подтвержденный сертификатом IP электрощитов и химически стойкие материалы, из которых он изготовлен, позволяют использовать устройство в гигиенических процессах в пищевой и фармацевтической промышленности. В сочетании с приводом Bürkert ELEMENT, уникальная система уплотнений клапана обеспечивает возможность циркуляции сжатого воздуха внутри клапана, предотвращая тем самым загрязнение клапана от окружающей среды.</p>		<p>* Под давлением должно быть не менее, чем на 0,5-1 бар выше минимального требуемого управляющего давления привода.</p>	

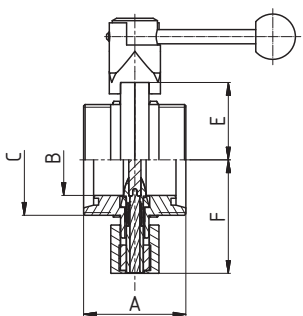
<p>ЗАТВОР С КОНТРОЛЕМ ПРОТЕЧКИ РЕЗЬБА-РЕЗЬБА</p> 	<p>45613</p>	<p>РАЗМЕРЫ</p>								
		<p>DN</p> <p>A</p> <p>B</p> <p>C</p> <p>E</p> <p>F</p> <p>кг</p>	<p>25</p> <p>32</p> <p>40</p> <p>50</p> <p>65</p> <p>80</p> <p>100</p>	<p>64</p> <p>64</p> <p>72</p> <p>72</p> <p>76</p> <p>100</p> <p>104</p>	<p>26</p> <p>32</p> <p>38</p> <p>50</p> <p>66</p> <p>81</p> <p>100</p>	<p>52x1/6"</p> <p>58x1/6"</p> <p>65x1/6"</p> <p>78x1/6"</p> <p>95x1/6"</p> <p>110x1/4"</p> <p>130x1/4"</p>	<p>43,5</p> <p>46</p> <p>48,5</p> <p>55</p> <p>63,5</p> <p>71</p> <p>81</p>	<p>65</p> <p>68</p> <p>71</p> <p>80</p> <p>89</p> <p>99</p> <p>109</p>		

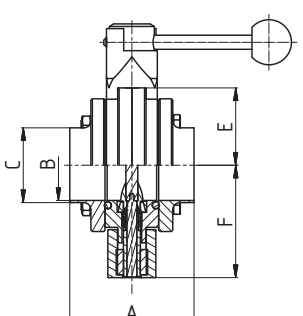
<p>ЗАТВОР С КОНТРОЛЕМ ПРОТЕЧКИ МЕЖФЛАНЦЕВЫЙ</p> 	<p>45618</p>	<p>РАЗМЕРЫ</p>								
		<p>DN</p> <p>A</p> <p>B</p> <p>C</p> <p>E</p> <p>F</p> <p>кг</p>	<p>40</p> <p>50</p> <p>65</p>	<p>88</p> <p>88</p> <p>88</p>	<p>38</p> <p>50</p> <p>66</p>	<p>43</p> <p>53</p> <p>72</p>	<p>48,5</p> <p>55</p> <p>63,5</p>	<p>71</p> <p>80</p> <p>89</p>		

ЗАТВОР С КОНТРОЛЕМ ПРОТЕЧКИ ДВУХДИСКОВЫЙ МЕЖФЛАНЦЕВЫЙ
45628
РАЗМЕРЫ

DIN

DN

A

B

C

D

25	122		26	87
32	122		32	92
40	130		38	97
50	130		50	110
65	146		66	127
80	185		81	142
100	209		100	162
125				
150				

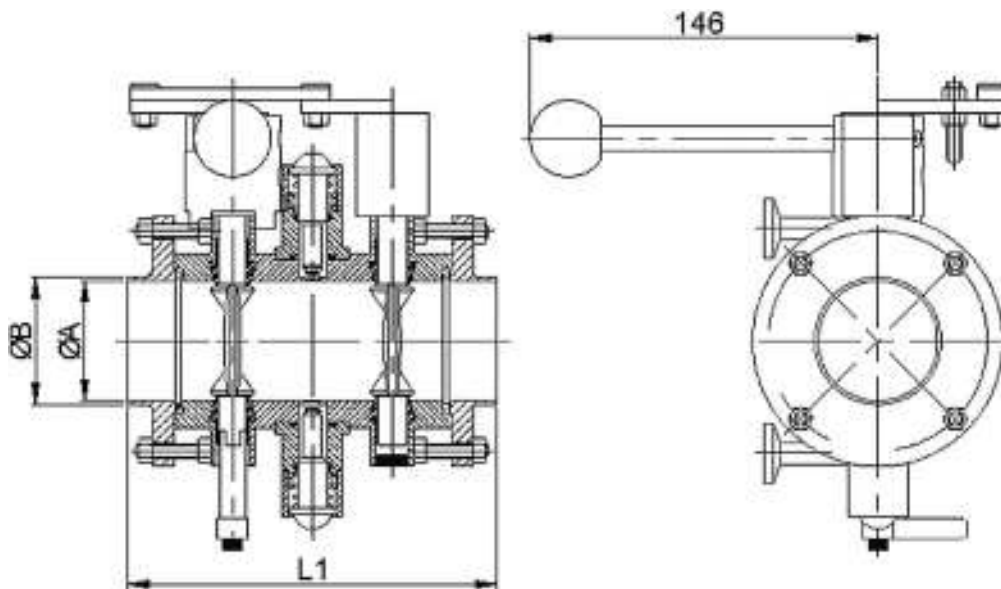
ЗАТВОР С КОНТРОЛЕМ ПРОТЕЧКИ ДВУХДИСКОВЫЙ МЕЖФЛАНЦЕВЫЙ
45628-P20
РАЗМЕРЫ

DIN

DN

A

B

C

D

25	148	30	26	87
32	148	36	32	92
40	158	42	38	97
50	158	54	50	110
65	170	71	66	127
80	221	86	81	142
100	221	105	100	162
125				
150				

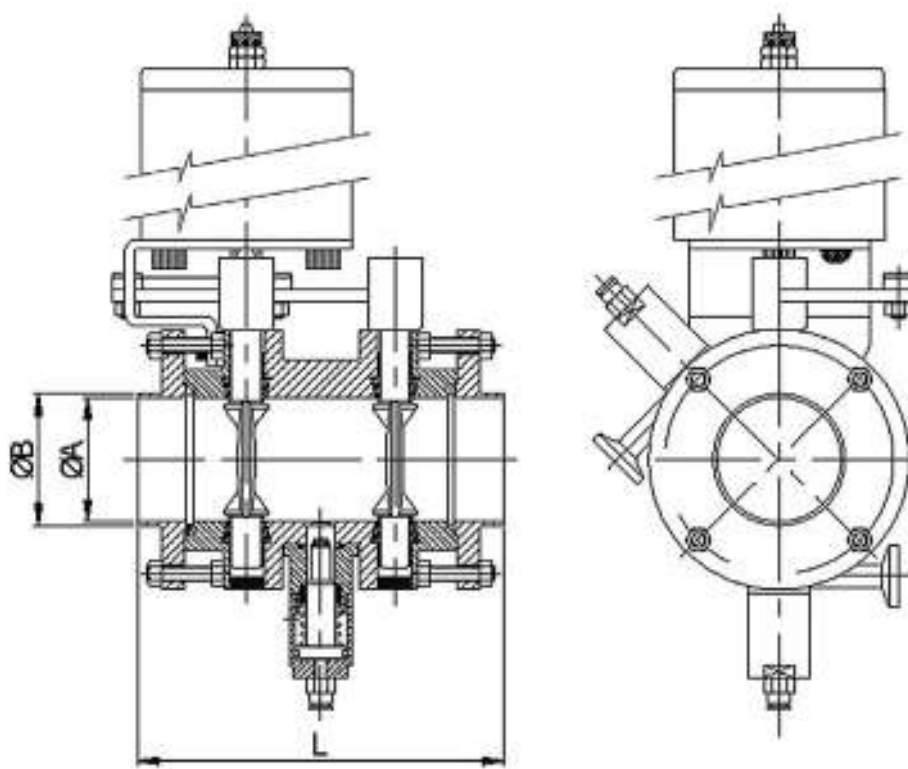

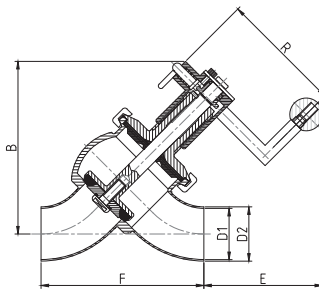
КЛАПАН СЕДЕЛЬНЫЙ Y-ТИП	47290		РАЗМЕРЫ								кг
	DN	R	B	C	D1	D2	E	F			
	25	60	124		26	29	69	111,8			
	40	120	160		38	41	117	145,4			
	50	120	168		50	53	115	159,0			
	65	120	198		66	70	122	187,2			
	80	120	204		81	85	113	205,9			

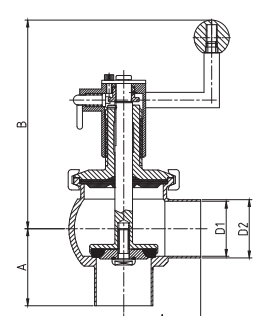
КЛАПАН СЕДЕЛЬНЫЙ L-ТИП	47300		РАЗМЕРЫ								кг
	DN	A	B	C	D1	D2					
	25	50	135		26	29					
	40	60	181		38	41					
	50	70	189		50	53					
	65	80	218		66	70					
	80	90	219		81	85					

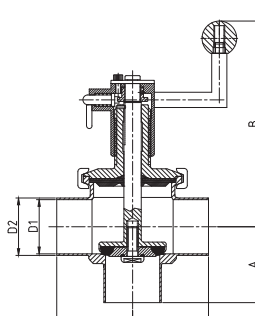
КЛАПАН СЕДЕЛЬНЫЙ T-ТИП	47310		РАЗМЕРЫ								кг
	DN	A	B	C	D1	D2					
	25	50	135		26	29					
	40	60	181		38	41					
	50	70	189		50	53					
	65	80	218		66	70					
	80	90	219		81	85					

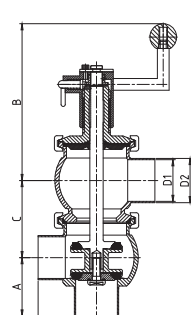
КЛАПАН СЕДЕЛЬНЫЙ LL-ТИП	47320		РАЗМЕРЫ								кг
	DN	A	B	C	D1	D2					
	25	50	119	56,6	26	29					
	40	60	184	80,0	38	41					
	50	70	188	92,4	50	53					
	65	80	221	120,0	66	70					
	80	90	226	128,0	81	85					

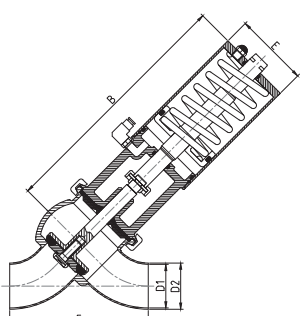
КЛАПАН СЕДЕЛЬНЫЙ Y-ТИП С ПНЕВМОПРИВОДОМ	47290-P45		РАЗМЕРЫ									
	NC		DN	B	D1	D2	E	F				кг
			25	47,0	26	29	60	111,8				
			40	277,7	38	41	85	145,4				
			50	284,1	50	53	85	159,0				
			65	357,8	66	70	133	187,2				
			85	360,9	81	85	133	205,9				

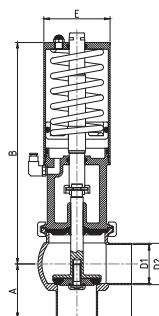
КЛАПАН СЕДЕЛЬНЫЙ L-ТИП С ПНЕВМОПРИВОДОМ	47300-P45		РАЗМЕРЫ									
	NC		DN	A	B	D1	D2	E				кг
			25	50	147,0	26	29	60				
			40	60	277,7	38	41	85				
			50	70	284,1	50	53	85				
			65	80	357,8	66	70	133				
			85	90	360,9	81	85	133				

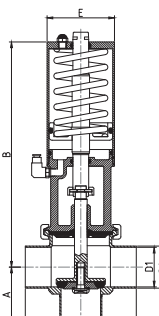
КЛАПАН СЕДЕЛЬНЫЙ T-ТИП С ПНЕВМОПРИВОДОМ	47310-P45		РАЗМЕРЫ									
	NC		DN	A	B	D1	D2	E				кг
			25	50	147,0	26	29	60				
			40	60	277,7	38	41	85				
			50	70	284,1	50	53	85				
			65	80	357,8	66	70	133				
			85	90	360,9	81	85	133				

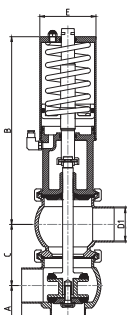
КЛАПАН СЕДЕЛЬНЫЙ LL-ТИП С ПНЕВМОПРИВОДОМ	47320-P45		РАЗМЕРЫ									
	NC		DN	A	B	C	D	E	R			кг
			25	50	147,0	56,6	26	29	60			
			40	60	277,7	80,0	38	41	85			
			50	70	284,1	92,4	50	53	85			
			65	80	357,8	120,0	66	70	133			
			85	90	360,9	128,1	81	85	133			

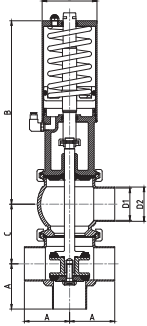
КЛАПАН СЕДЕЛЬНЫЙ LT-ТИП ВОЗДУХ-ПРУЖИНА (СТАЛЬ AISI 316L)	47330-P45		РАЗМЕРЫ										
	NC	DN	A	B	C	D	E	R					кг
		25	50	147,0	56,6	26	29	60					
		40	60	277,7	80,0	38	41	85					
		50	70	284,1	92,4	50	53	85					
		65	80	357,8	120,0	66	70	133					
		80	90	360,9	128,1	81	85	133					

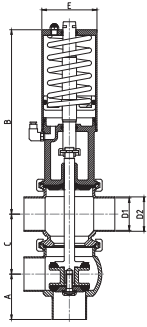
КЛАПАН СЕДЕЛЬНЫЙ TL-ТИП ВОЗДУХ-ПРУЖИНА (СТАЛЬ AISI 316L)	47340-P45		РАЗМЕРЫ										
	NC	DN	A	B	C	D1	D2	E					кг
		25	50	147,0	56,6	26	29	60					
		40	60	277,7	80,0	38	41	85					
		50	70	284,1	92,4	50	53	85					
		65	80	357,8	120,0	66	70	133					
		80	90	360,9	128,1	81	85	133					

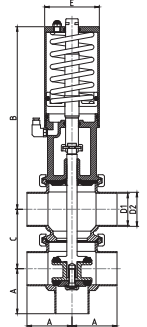
КЛАПАН СЕДЕЛЬНЫЙ TT-ТИП ВОЗДУХ-ПРУЖИНА (СТАЛЬ AISI 316L)	47350-P45		РАЗМЕРЫ										
	NC	DN	A	B	C	D1	D2	E					кг
		25	50	147,0	56,6	26	29	60					
		40	60	277,7	80	38	41	85					
		50	70	284,1	92,4	50	53	85					
		65	80	357,8	120,0	66	70	133					
		80	90	360,9	128,1	81	85	133					

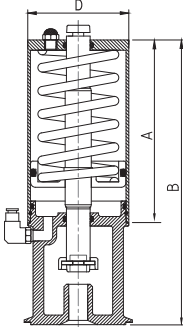
ПНЕВМОПРИВОД ДЛЯ СЕДЕЛЬНОГО КЛАПАНА ВОЗДУХ-ПРУЖИНА	47450-P45		РАЗМЕРЫ										
	NC	DN	A	B	C	D							кг
		25	175			89							
		40-50	175			104							
		65-80	230			129							

ЗАТВОР ДИСКОВЫЙ С ПНЕВМОПРИВОДОМ 44200, 44150

СХЕМА СБОРКИ

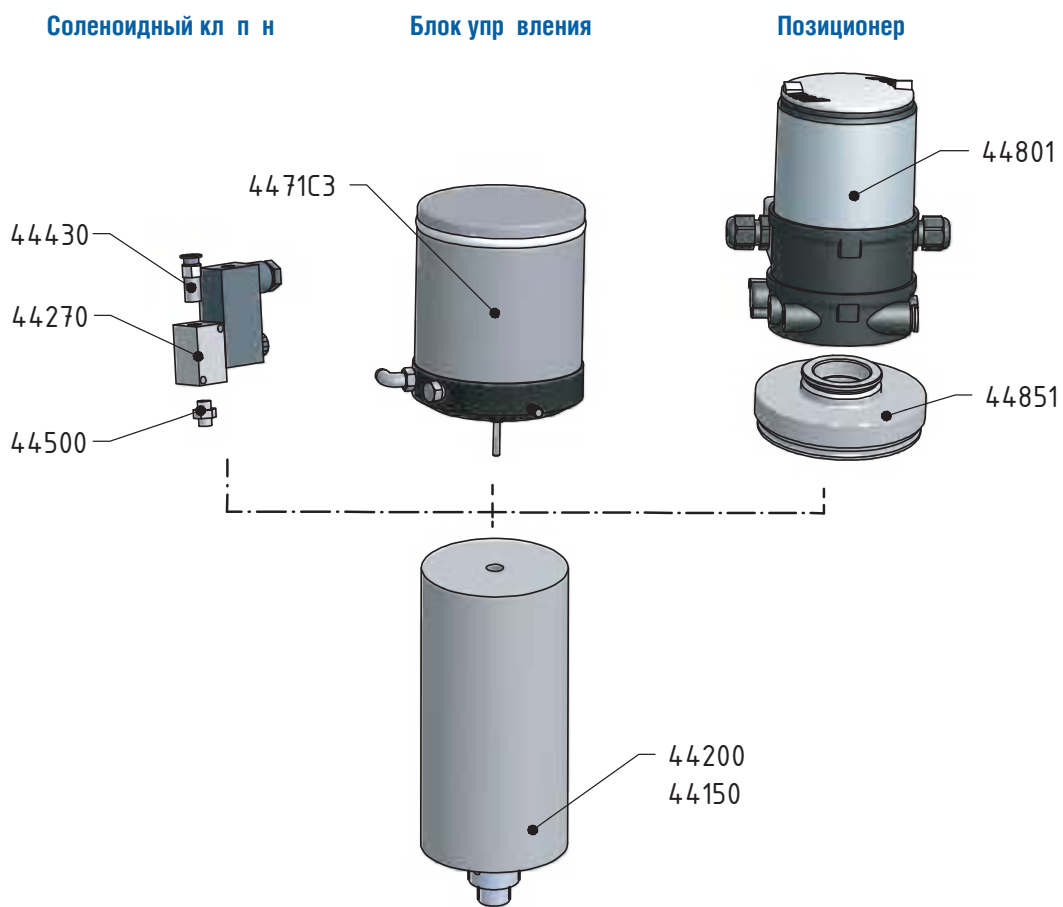

ВАРИАНТЫ СБОРКИ

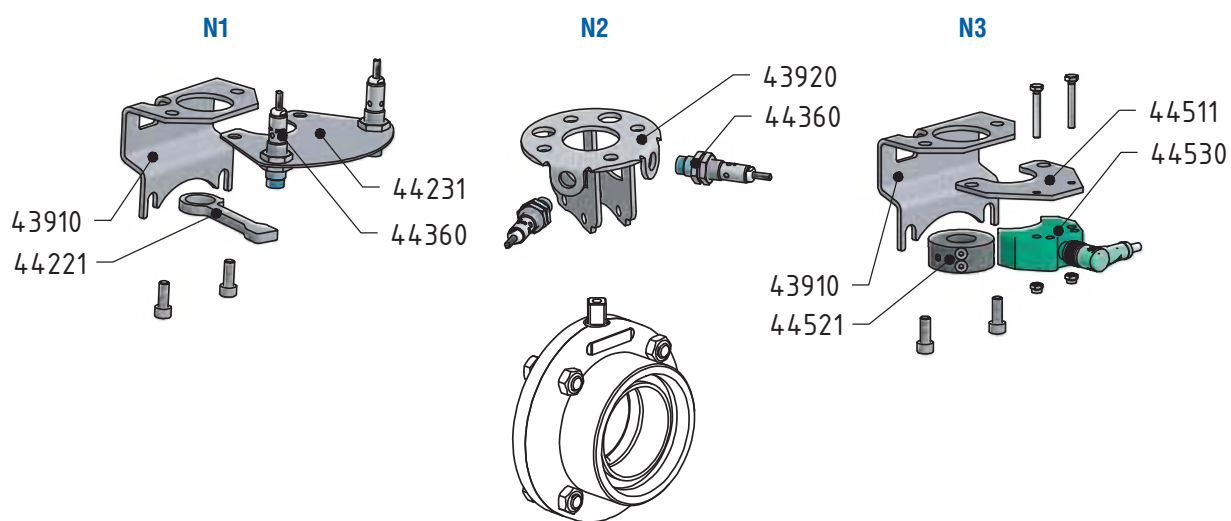

ЗАТВОР ДИСКОВЫЙ С ПНЕВМОПРИВОДОМ 44050, 44100

СХЕМА СБОРКИ

ВАРИАНТЫ СБОРКИ

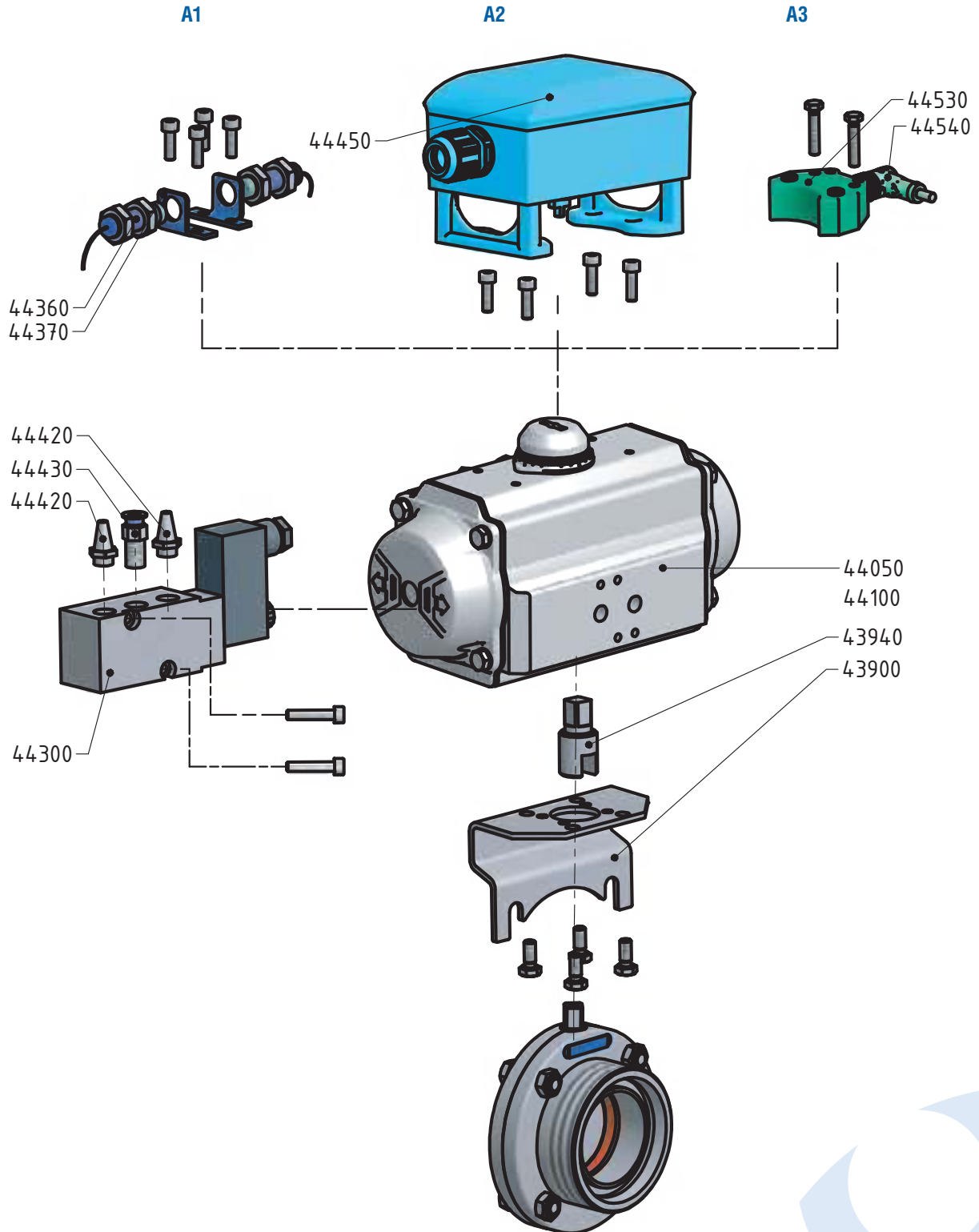

ЗАТВОР ДИСКОВЫЙ С ПНЕВМОПРИВОДОМ 44160, 44210

СХЕМА СБОРКИ

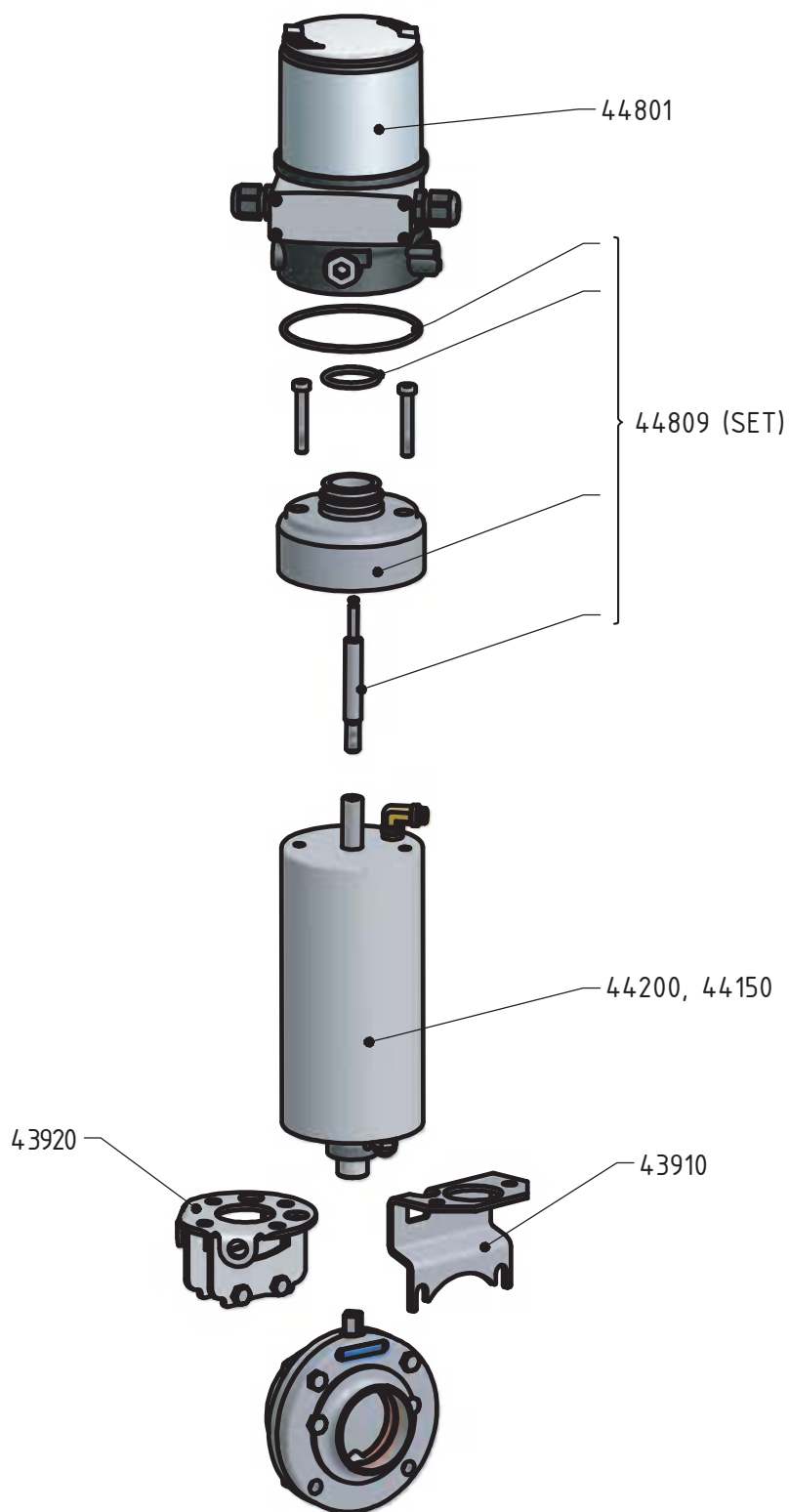

ЗАТВОР ДИСКОВЫЙ С ЭЛЕКТРОПРИВОДОМ
СХЕМА СБОРКИ

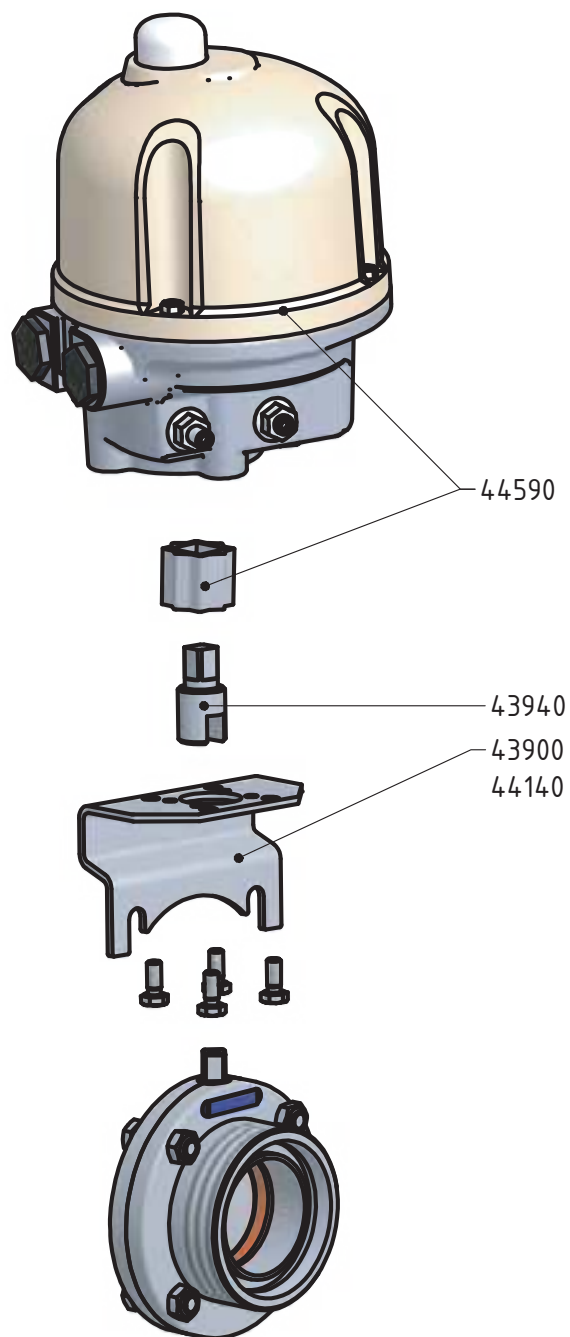

4

Специальная арматура и комплектующие

Обратные клапаны
Пробоотборники
Смотровые стекла
Уровнемеры
Фильтры
Антивакуумные клапаны
Предохранительные клапаны
Арматура для емкостного оборудования

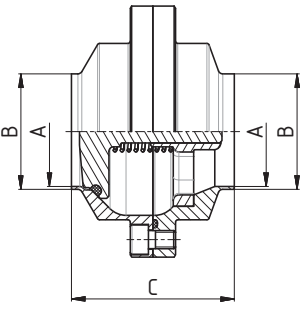
ОБРАТНЫЙ КЛАПАН СВАРКА-СВАРКА	5060D		РАЗМЕРЫ			
	SMS		DN	A	B	C
	25		22,5	25	64	
	38		35,5	38	72	
	51		48,5	51	72	
	63,5		60,5	63,5	76	
	76		72,9	76,1	96	

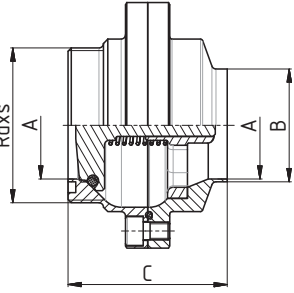
ОБРАТНЫЙ КЛАПАН РЕЗЬБА-СВАРКА	5061D		РАЗМЕРЫ				
	SMS		DN	A	B	C	Rd x s
	25		22,5	25	64	40x1/6"	
	38		35,5	38	72	60x1/6"	
	51		48,5	51	72	70x1/6"	
	63,5		60,5	63,5	76	85x1/6"	
	76		72,9	76,1	96	98x1/6"	

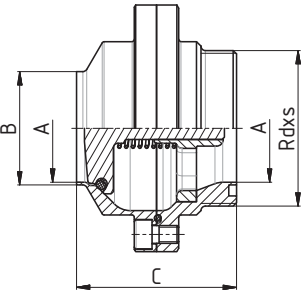
ОБРАТНЫЙ КЛАПАН СВАРКА-РЕЗЬБА	5062D		РАЗМЕРЫ										
	SMS		DN	A	B	C	D	E	F	R	L	Rd x s	кг
	25		22,5	25	64							40x1/6"	
	38		35,5	38	72							60x1/6"	
	51		48,5	51	72							70x1/6"	
	63,5		60,5	63,5	76							85x1/6"	
	76		72,9	76,1	96							98x1/6"	

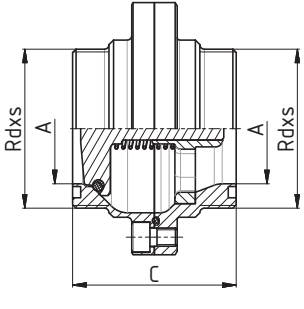
ОБРАТНЫЙ КЛАПАН РЕЗЬБА-РЕЗЬБА	5063D		РАЗМЕРЫ										
	SMS		DN	A	B	C	D	E	F	R	L	Rd x s	кг
	25		22,5			64						40x1/6"	
	38		35,5			72						60x1/6"	
	51		48,5			72						70x1/6"	
	63,5		60,5			76						85x1/6"	
	76		72,9			96						98x1/6"	

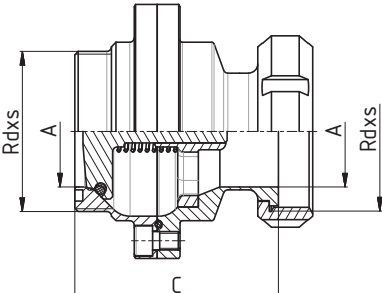
ОБРАТНЫЙ КЛАПАН РЕЗЬБА-ГАЙКА	5064D		РАЗМЕРЫ			
	SMS		DN	A	C	Rd x s
	25		22,5	83	40x1/6"	
	38		35,5	95	60x1/6"	
	51		48,5	95	70x1/6"	
	63,5		60,5	103	85x1/6"	
	76		72,9	123	98x1/6"	

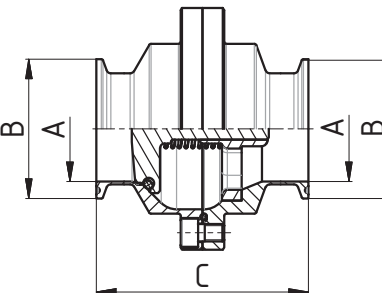
ОБРАТНЫЙ КЛАПАН КЛАМП-КЛАМП	5069D		РАЗМЕРЫ			
	SMS		DN	A	B	C
	25		22,5	50,5	89,4	
	38		35,5	50,5	97,4	
	51		48,5	64	97,4	
	63,5		60,5	77,5	101,4	
	76		72,9	91	121,4	

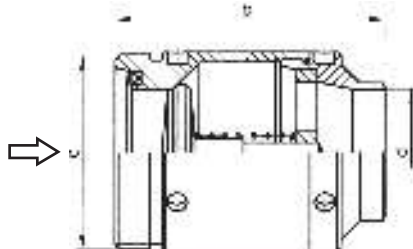
ОБРАТНЫЙ КЛАПАН РЕЗЬБА-СВАРКА	5081A	РАЗМЕРЫ									
		DN	A	B	резьб DIN 405 C	D	E	F	R	L	кг
	10		60	28x1/8"	10						0,18
	15		60	34x1/8"	16						0,24
	20		70	44x1/6"	20						0,3

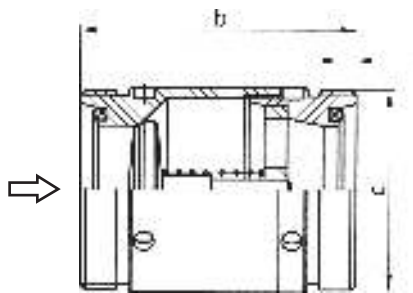
ОБРАТНЫЙ КЛАПАН РЕЗЬБА-РЕЗЬБА	5083A	РАЗМЕРЫ									
		DN	A	B	резьб DIN 405 C	D	E	F	R	L	кг
	10		60	28x1/8"	10						0,19
	15		60	34x1/8"	16						0,25
	20		70	44x1/6"	20						0,31

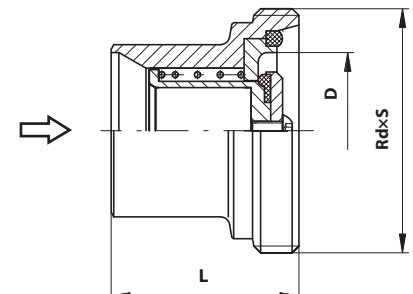
ОБРАТНЫЙ КЛАПАН СВАРКА-РЕЗЬБА	5082B	РАЗМЕРЫ									
		DN	A	B	C	D	E	F	R	L	резьб DIN 405 Rd x s
	025				26				42		0,210
	032				32				50		0,300
	040				38				50		0,390
	050				50				60		0,680
	065				66				70		1,400
	080				81				80		2,000

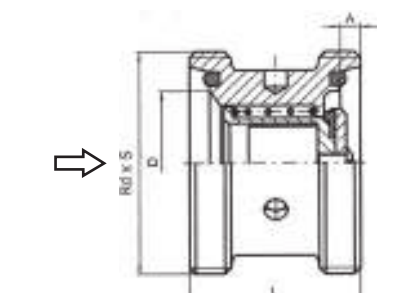
ОБРАТНЫЙ КЛАПАН РЕЗЬБА-РЕЗЬБА	5083B	РАЗМЕРЫ									
		DN	A	B	C	D	E	F	R	L	резьб DIN 405 Rd x s
	25	7			26				42	52x1/6"	0,30
	32	7			32				50	58x1/6"	0,41
	40	7			38				50	65x1/6"	0,60
	50	7			50				60	78x1/6"	1,05
	65	8			66				70	95x1/6"	

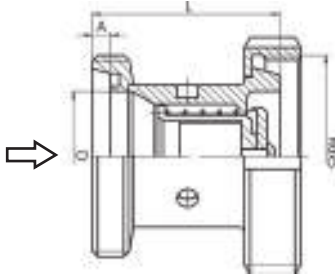
ОБРАТНЫЙ КЛАПАН РЕЗЬБА-ГАЙКА	5084В	РАЗМЕРЫ										
		DN	A	B	C	D	E	F	R	L	резьб DIN 405 Rd x s	кг
	25	7			26					55	52x1/6"	0,30
	32	7			32					63	58x1/6"	0,41
	40	7			38					63	65x1/6"	0,60
	50	7			50					73	78x1/6"	1,05
	65	8			66					85	95x1/6"	

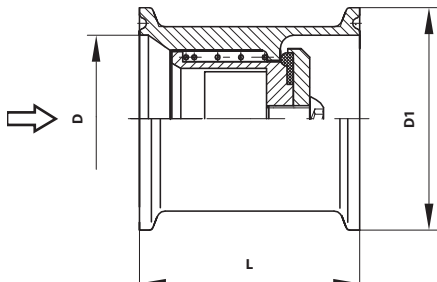
ОБРАТНЫЙ КЛАПАН КЛАМП-КЛАМП	5089В	РАЗМЕРЫ										
		DN	A	B	C	D	E	F	R	L	резьб DIN 405 Rd x s	кг
	25				26	50,5				42		
	32				32	50,5				50		
	40				38	50,5				50		
	50				50	64				60		
	65				66	91				70		

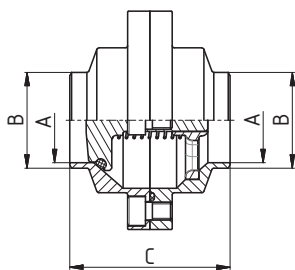
ОБРАТНЫЙ КЛАПАН СВАРКА-СВАРКА	5080D	РАЗМЕРЫ										
		DN	A	B	C	D	E	F	R	L	резьб DIN 405 Rd x s	кг
	25	26	31	64	87							0,95
	32	32	37	66	93							1,35
	40	38	43	72	98							1,55
	50	50	55	72	111							1,65
	65	66	72	76	128							2,2
	80	81	87	96	144							3,7
	100	100	106	104	130							4,78

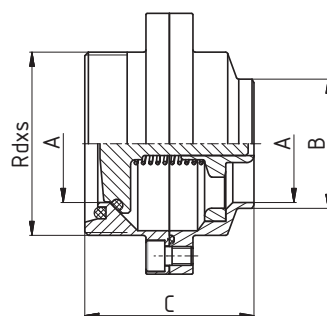
ОБРАТНЫЙ КЛАПАН РЕЗЬБА-СВАРКА	5081D	РАЗМЕРЫ										
		DN	A	B	C	D	E	F	R	L	резьб DIN 405 Rd x s	кг
	25	26	31	64	87						52x1/6"	1
	32	32	37	66	93						58x1/6"	1,15
	40	38	43	72	98						65x1/6"	1,36
	50	50	55	72	111						78x1/6"	1,75
	65	66	72	76	128						95x1/6"	2,38
	80	81	87	96	144						110x1/4"	3,85
	100	100	106	104	130						130x1/4"	4,88

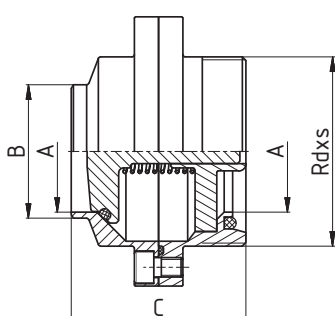
ОБРАТНЫЙ КЛАПАН СВАРКА-РЕЗЬБА	5082D		РАЗМЕРЫ									
	DN	A	B	C	D	E	F	R	L	резьб DIN 405 Rd x s	кг	
	25	26		31	64	87					52x1/6"	1
	32	32		37	66	93					58x1/6"	1,15
	40	38		43	72	98					65x1/6"	1,36
	50	50		55	72	111					78x1/6"	1,75
	65	66		72	76	128					95x1/6"	2,38
	80	81		87	96	144					110x1/4"	3,85
	100	100		106	104	130					130x1/4"	4,88

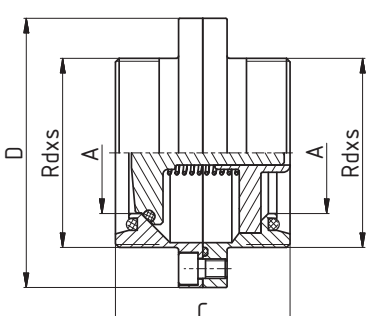
ОБРАТНЫЙ КЛАПАН РЕЗЬБА-РЕЗЬБА	5083D		РАЗМЕРЫ									
	DN	A	B	C	D	E	F	R	L	резьб DIN 405 Rd x s	кг	
	25	26		64	87						52x1/6"	1,08
	32	32		66	93						58x1/6"	1,25
	40	38		72	98						65x1/6"	1,44
	50	50		72	111						78x1/6"	1,88
	65	66		76	128						95x1/6"	2,52
	80	81		96	144						110x1/4"	3,98
	100	100		104	130						130x1/4"	4,98

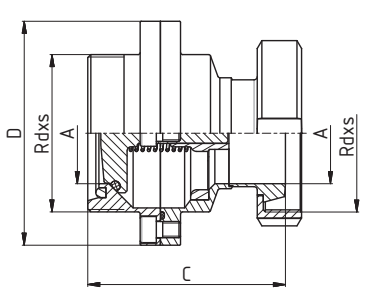
ОБРАТНЫЙ КЛАПАН РЕЗЬБА-ГАЙКА	5084D		РАЗМЕРЫ									
	DN	A	B	C	D	E	F	R	L	резьб DIN 405 Rd x s	кг	
	25	26		84	87						52x1/6"	1,28
	32	32		89	93						58x1/6"	1,73
	40	38		96	98						65x1/6"	2,06
	50	50		98	111						78x1/6"	0,14
	65	66		109	128						95x1/6"	3,5
	80	81		135	143						110x1/4"	4,84
	100	100		146	164						130x1/4"	

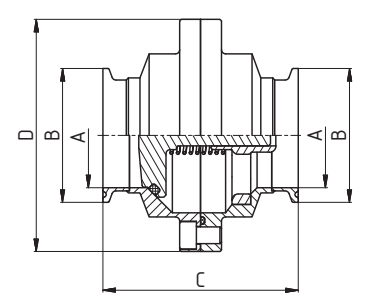
ОБРАТНЫЙ КЛАПАН КЛАМП-КЛАМП	5089D		РАЗМЕРЫ									
	DN	A	B	C	D	E	F	R	L	резьб DIN 405 Rd x s	кг	
	25	26	50,5	85,4	87							1,08
	32	32	50,5	87,5	93							1,16
	40	38	50,5	93,5	98							1,33
	50	50	64	93,5	111							1,76
	65	66	91	97,5	128							2,51
	80	81	106	148	144							4,01
	100	100	119	156	130							5,02

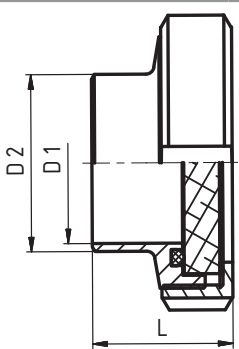
СТЕКЛО ТОРЦЕВОЕ СМОТРОВОЕ	51510		РАЗМЕРЫ									
	DN	D1	D2	C	D	E	F	R	L	резьб DIN 405 Rd x s	кг	
	20	20	25						30		0,300	
	25	26	31						36		0,350	
	32	32	37						39		0,420	
	40	38	43						42		0,530	
	50	50	55						45		0,726	
	65	66	72						50		1,110	
	80	81	87						55		1,590	
	100	100	106						65		2,380	
	125	125	132						55		3,570	
	150	150	157						60		5,400	

Уплотнение: NBR / POM
PTFE / PTFE

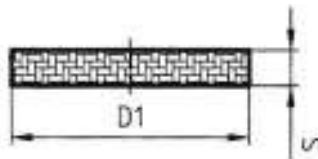
СТЕКЛО ПЛОСКОЕ	51520		РАЗМЕРЫ		
	DN	D1	S	кг	
	20	36	5	0,012	
	25	44	5	0,018	
	32	50	6,5	0,04	
	40	56	6,5	0,045	
	50	69	11	0,09	
	65	86	11	0,13	
	80	99	11	0,2	
	100	119	15	0,3	
	125	145	15	0,55	
	150	180	15	0,83	

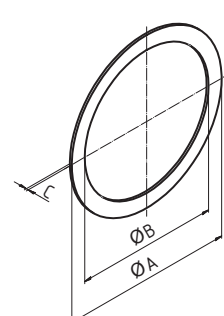
УПЛОТНЕНИЕ	51513		РАЗМЕРЫ		
	DN	A	B	C	
	20	31	40,5	1	
	25	36	48,5	1	
	32	42	53,5	1	
	40	49	61,5	1	
	50	62	74,5	1	
	65	80	91	1	
	80	94	104,6	1	
	100	115	124,8	1	
	125	138	154,7	1	
	150	164	184,6	1	

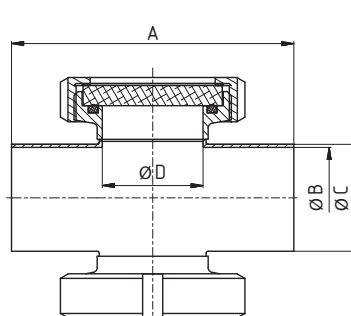
СТЕКЛО ТОРЦЕВОЕ СДВОЕННОЕ СВАРКА-СВАРКА	51530		РАЗМЕРЫ									
	DN	A	B	C	D	E	F	R	L	резьб DIN 405 Rd x s	кг	
	25	100	26	29	26						0,65	
	32	110	32	35	32						0,78	
	40	120	38	41	38						1	
	50	140	50	53	50						1,4	
	65	160	66	70	66						2,45	
	80	180	81	85	66						3,4	
	100	200	100	104	66						5,1	
	125	250	125	129	80						8,6	
	150	280	150	154	80						12,8	

Уплотнение: NBR / POM
PTFE / PTFE

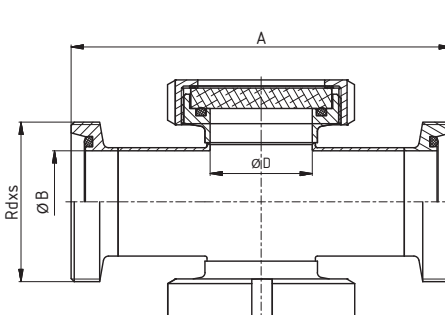
СТЕКЛО ТОРЦЕВОЕ СДВОЕННОЕ РЕЗЬБА-РЕЗЬБА	51531		РАЗМЕРЫ									
	DN	A	B	C	D	E	F	R	L	резьб DIN 405 Rd x s	кг	
	25	144	26		26					52x1/6"	0,65	
	32	154	32		32					58x1/6"	0,78	
	40	164	38		38					65x1/6"	1	
	50	186	50		50					78x1/6"	1,4	
	65	210	66		66					95x1/6"	2,45	
	80	230	81		66					110x1/4"	3,4	
	100	260	100		66					130x1/4"	5,1	
	125	321	125		80					160x1/4"	8,6	
	150	360	150		80					190x1/4"	12,8	

Уплотнение: NBR / POM
PTFE / PTFE

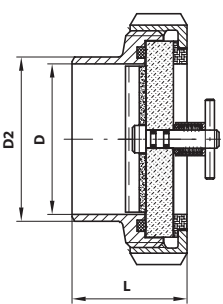
СТЕКЛО СМОТРОВОЕ СО СТЕКЛООЧИСТИТЕЛЕМ	51540	РАЗМЕРЫ										
		DN	D1	D2	C	D	E	F	R	L	резьб DIN 405 Rd x s	кг
	65	66	72							50		1,110
	80	81	87							55		1,590
	100	100	106							65		2,380

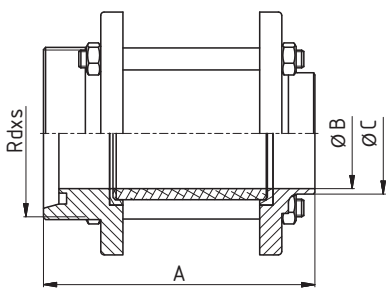
СТЕКЛО СМОТРОВОЕ РЕЗЬБА-СВАРКА	51550	РАЗМЕРЫ										
		DN	A	B	C	D	E	F	R	L	резьб DIN 405 Rd x s	кг
	25	115	26	31							52x1/6"	1,18
	32	116	32	37							58x1/6"	1,28
	40	124	38	43							65x1/6"	1,48
	50	124	50	55							78x1/6"	1,8
	65	141	66	72							95x1/6"	2,26
	80	156	81	87							110x1/4"	3,68
	100	190	100	106							130x1/4"	4,8
	125	247	125	138							160x1/4"	5,4
	150	251	150	162							190x1/4"	7

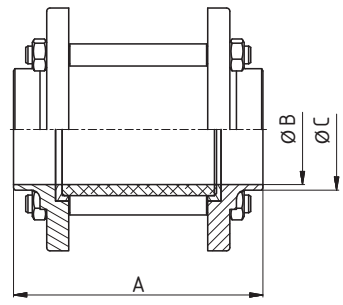
СТЕКЛО СМОТРОВОЕ СВАРКА-СВАРКА	51560	РАЗМЕРЫ										
		DN	A	B	C	D	E	F	R	L	резьб DIN 405 Rd x s	кг
	25	102	26	31								1
	32	104	32	37								1,12
	40	112	38	43								1,24
	50	112	50	55								1,46
	65	127	66	72								1,84
	80	135	81	87								2,94
	100	169	100	106								3,88
	125	229	125	138								4,2
	150	229	150	162								5,8

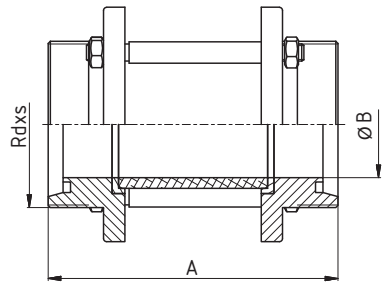
СТЕКЛО СМОТРОВОЕ РЕЗЬБА-РЕЗЬБА	51570	РАЗМЕРЫ										
		DN	A	B	C	резьб DIN 405 D	E	F	R	L	кг	
	25	144		26		52x1/6"						1,25
	32	144		32		58x1/6"						1,38
	40	144		38		65x1/6"						1,7
	50	164		50		78x1/6"						1,9
	65	172		66		95x1/6"						2,25
	80	205		81		100x1/4"						3,1
	100	209		100		130x1/4"						3,75
	125	265		125		160x1/4"						6,4
	150	273		150		190x1/4"						7,8

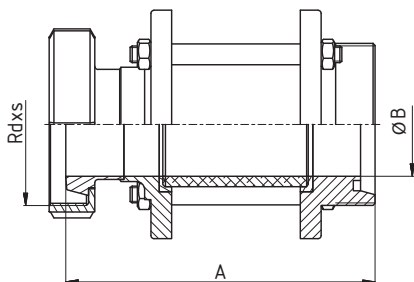
СТЕКЛО СМОТРОВОЕ ГАЙКА-РЕЗЬБА	51580	РАЗМЕРЫ										резьб DIN 405 Rd x s	кг
		DN	A	B	C	D	E	F	R	L			
	25	134	26									52x1/6"	0,62
	32	138	32									58x1/6"	0,72
	40	147	38									65x1/6"	0,95
	50	149	50									78x1/6"	1,5
	65	170	66									95x1/6"	2,07
	80	190	81									110x1/4"	2,6
	100	231	100									130x1/4"	3,6
	125	277	125									160x1/4"	7,85
	150	284	150									190x1/4"	9,68

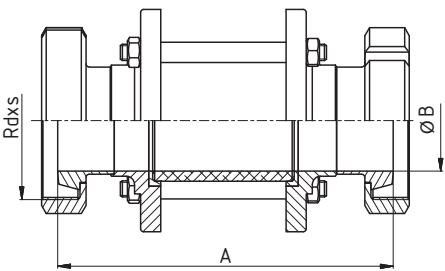
СТЕКЛО СМОТРОВОЕ ГАЙКА-ГАЙКА	51590	РАЗМЕРЫ										резьб DIN 405 Rd x s	кг
		DN	A	B	C	D	E	F	R	L			
	25	148		26								52x1/6"	0,64
	32	156		32								58x1/6"	0,74
	40	166		38								65x1/6"	0,97
	50	190		50								78x1/6"	1,87
	65	198		66								95x1/6"	2,62
	80	237		81								100x1/4"	3,63
	100	253		100								130x1/4"	4,51
	125	289		125								160x1/4"	9,3
	150	295		150								190x1/4"	11,56

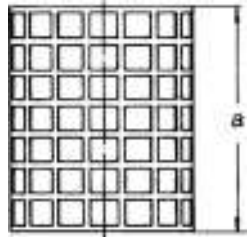
КОЖУХ СТЕКЛА СМОТРОВОГО	51701	РАЗМЕРЫ										резьб DIN 405 Rd x s	кг
		DN	A	B	C	D	E	F	R	L			
	25	58											0,02
	32	58											0,04
	40	58											0,04
	50	58											0,04
	65	68											0,08
	80	68											0,1
	100	94											0,12
	125	135											1,34
	150	135											1,8

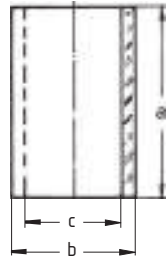
СТЕКЛО ЦИЛИНДРИЧЕСКОЕ	51710	РАЗМЕРЫ										резьб DIN 405 Rd x s	кг
		DN	A	B	C	D	E	F	R	L			
	25	70	32	26									0,05
	32	70	40	32									0,07
	40	70	50	40									0,12
	50	70	60	50									0,19
	65	85	75	65									0,24
	80	85	90	80									0,35
	100	115	110	100									0,45
	125	160	140	126									0,90
	150	160	165	150									1,35

УПЛОТНЕНИЕ	51720	РАЗМЕРЫ			
		DN	D	D1	S
		25	27	40	5
		32	33	48	5
		40	39	54,5	5,5
		50	51	66	5,5
		65	67	84	5,5
		80	81,6	100	5,8
		100	100	115	5,8

УПЛОТНЕНИЕ	51721	РАЗМЕРЫ			
		DN	D	D1	S
		25	27	37	6
		32	34	45	6
		40	40	55	6
		50	51	65	6
		65	66,5	80	6
		80	81,5	96	8
		100	101,5	116,5	8
		125	127	147,5	8,5
		150	151	171,5	8,5

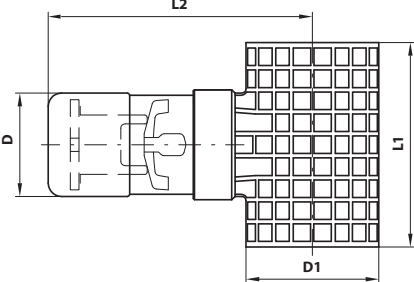
ПОДСВЕТКА	51800	РАЗМЕРЫ										
		DN	D1	D2	C	D	E	F	L1	L2	резьб. DIN 405 Rd x s	кг
		25	44,5	36					73	102,5		0,300
		32	44,5	44					73	106		0,390
		40	44,5	53					73	111,5		0,400
		50	44,5	63					93	116,5		0,420
		65	44,5	79					93	122		0,440
		80	44,5	95					111	136		0,460
		100	44,5	115					111	141		0,490
		125	44,5	145					152	169		
		150	44,5	168					152	169		

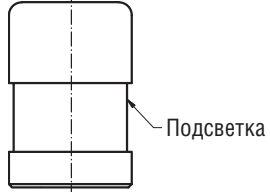
ПОДСВЕТКА	51850	РАЗМЕРЫ			
		DN			Цоколь
		20			
		25			
		32			
		40			
		50			
		65			
		Halogen	24V	20W	G4
	LED	12V	3W	MR11 (GU4)	

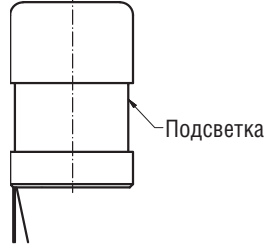
ПОДСВЕТКА С ДЕРЖАТЕЛЕМ	51850-D	РАЗМЕРЫ			
		DN			Цоколь
		20			
		25			
		32			
		40			
		50			
		65			
		Halogen	24V	20W	G4
	LED	12V	3W	MR11 (GU4)	

ПОДСВЕТКА С ГАЙКОЙ	51851	РАЗМЕРЫ			
		DN			Цоколь
		20			
		25			
		32			
		40			
		50			
		65			
		Halogen	24V	20W	G4
	LED	12V	3W	MR11 (GU4)	

СТЕКЛО СМОТРОВОЕ ТОРЦЕВОЕ С ПОДСВЕТКОЙ	51852	РАЗМЕРЫ			
		DN			Цоколь
		20			
		25			
		32			
		40			
		50			
		65			
		Halogen	24V	20W	G4
	LED	12V	3W	MR11 (GU4)	

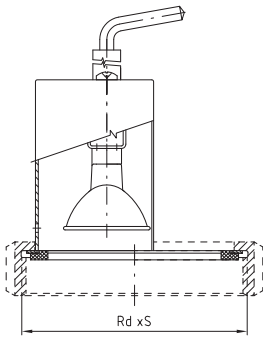
ПОДСВЕТКА	51860	РАЗМЕРЫ											
		DN	A	B	C	D	E	F	R	L	резьб DIN 405 Rd x s	кг	
	100											130x1/4"	
	125											160x1/4"	
	150											190x1/4"	
Н пряжение 24 В DC													

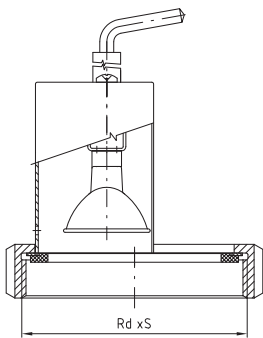
ПОДСВЕТКА С ГАЙКОЙ	51861	РАЗМЕРЫ											
		DN	A	B	C	D	E	F	R	L	резьб DIN 405 Rd x s	кг	
	80											110x1/4"	
Н пряжение 24 В DC													

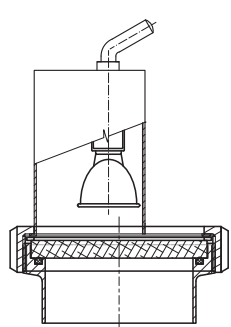
СТЕКЛО СМОТРОВОЕ ТОРЦЕВОЕ С ПОДСВЕТКОЙ	51862	РАЗМЕРЫ											
		DN	A	B	C	D	E	F	R	L	резьб DIN 405 Rd x s	кг	
	80											110x1/4"	
	100											130x1/4"	
	125											160x1/4"	
	150											190x1/4"	
Н пряжение 24 В DC													

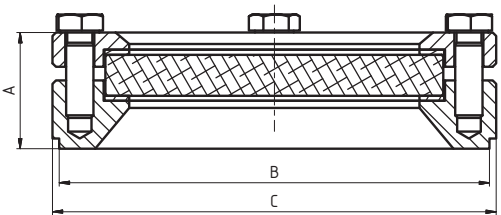
СТЕКЛО СМОТРОВОЕ ФЛАНЦЕВОЕ	51920	РАЗМЕРЫ											
		DN	A	B	C	D	E	F	R	L	резьб DIN 405 Rd x s	кг	
	80	34	126	130									1,5

ДЕКАНТАТОР

	КОМПЛЕКТУЮЩИЕ	МАТЕРИАЛ
1	Внешняя часть	AISI 304/316
2	Внутренняя часть	AISI 304/316
3	Труба	AISI 304/316
4	Отвод 90°	AISI 304/316
5	Уплотнение	PTFE
6	Уплотнение	PTFE
7	Внутреннее уплотнение	NBR
8	Рычаг поворота 180°	AISI 304
9	Крышка с резьбой	AISI 304
10	Шпилька	AISI 304

ДЕКАНТАТОР 90° ФЛАНЕЦ-ФЛАНЕЦ

52310

РАЗМЕРЫ

PN10

DN	A	B	C	D	E	F	кг
40	76	40	110	150	40	10	
50	76	49	125	165	52	10	
65	90	65	145	185	70	12	
80	94	79	160	200	85	12	

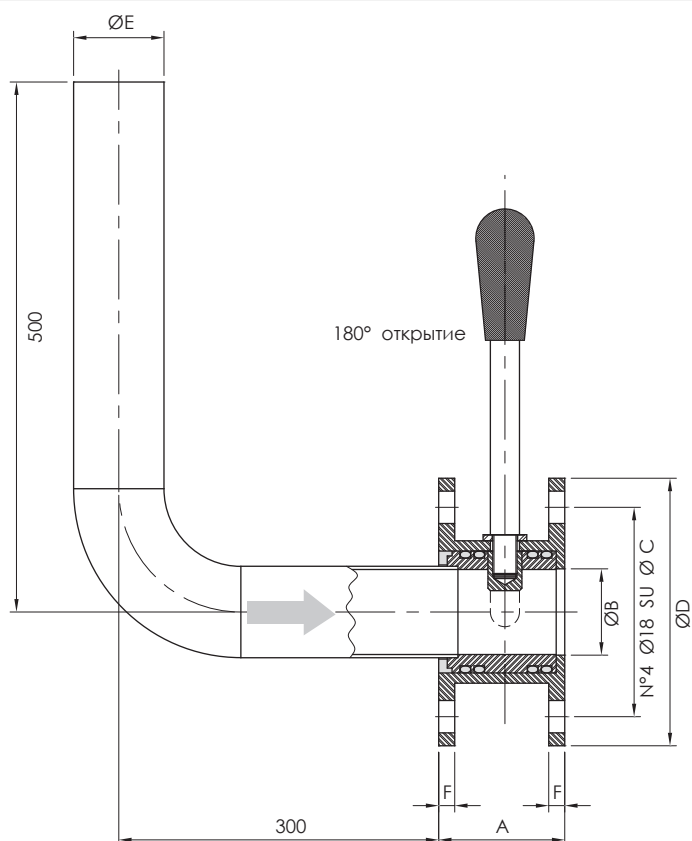

ДЕКАНТАТОР 90° ГАЙКА-РЕЗЬБА

52320

РАЗМЕРЫ

DN	A	B	C	D	E	F	кг
40	76	40	110	150	40	10	
50	76	49	125	165	52	10	
65	90	65	145	185	70	12	
80	94	79	160	200	85	12	

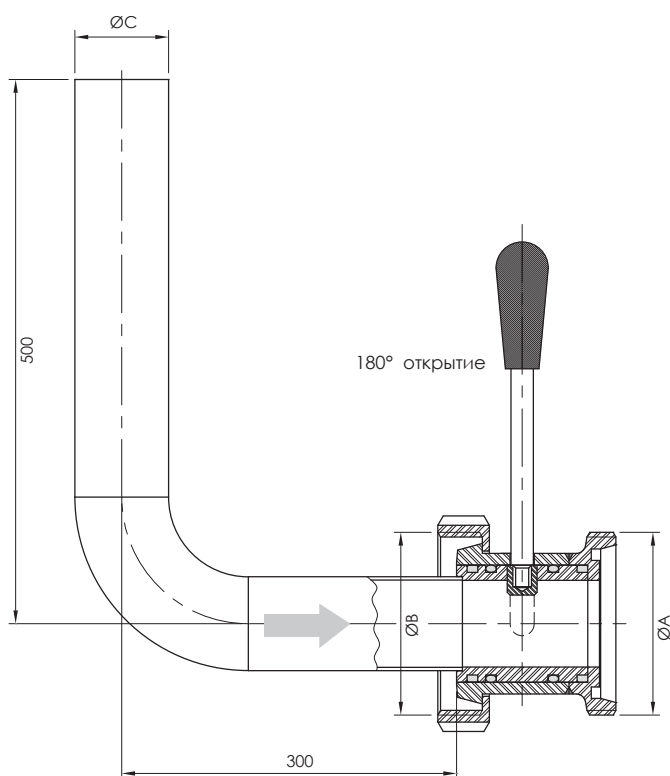

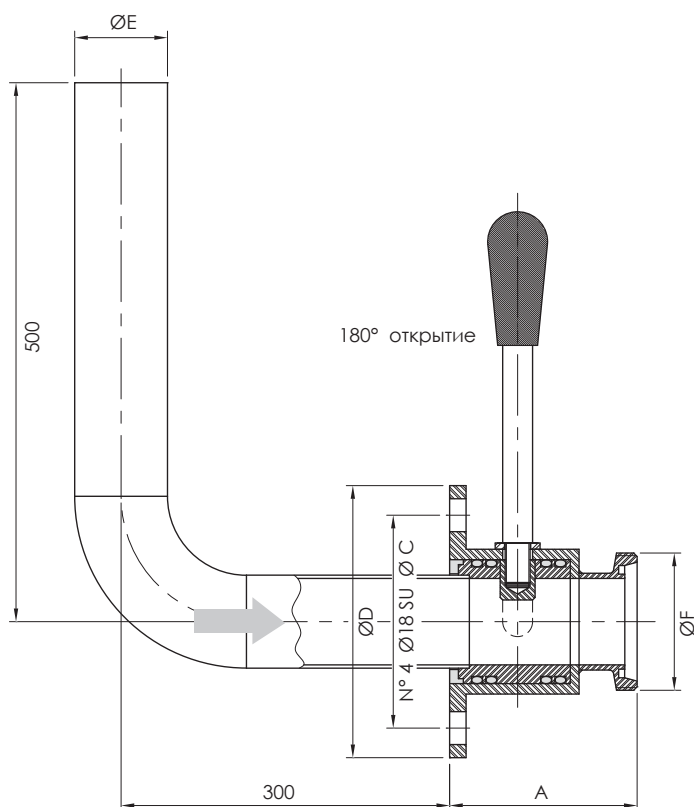
ДЕКАНТАТОР 90° ФЛАНЕЦ-РЕЗЬБА
52330
РАЗМЕРЫ

DN	A	B	C	D	E	F	кг
40	107		110	150	40	DIN 40	
50	109		125	165	52	DIN 50	
65	128		145	185	70	DIN 65	
80	135		160	200	85	DIN 80	

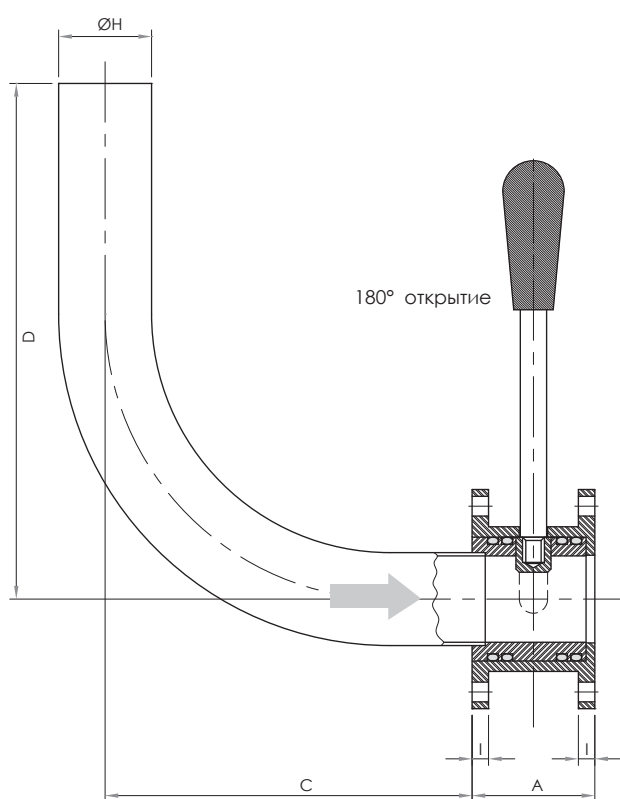
ДЕКАНТАТОР 90° ФЛАНЕЦ-ФЛАНЕЦ КВАДРАТНЫЙ
52340
РАЗМЕРЫ

PN10

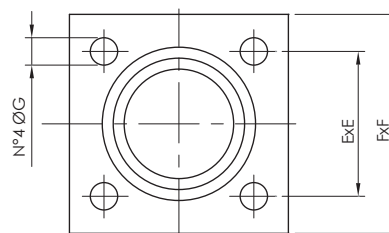
DN	A	C	D	E	F	G	H	I
40	56	195	195	75	100	M10	40	8
50	56	215	210	75	100	M10	54	8
70	64	285	260	90	120	M12	73	10

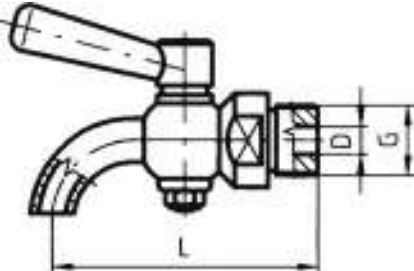

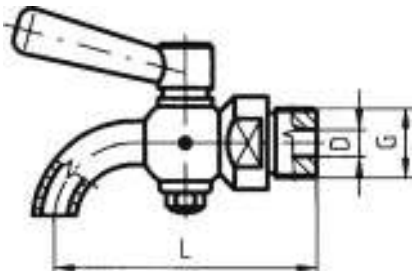
ПРОБООТБОРНИК	53010	РАЗМЕРЫ										резьб DIN 405 Rd x s	кг
		DN	A	B	C	D	E	F	G	L			
		4				4			1/4"				0,290
		6				6			3/8"				0,300
		8				8			1/2"				0,320
		12				12			3/4"				0,420

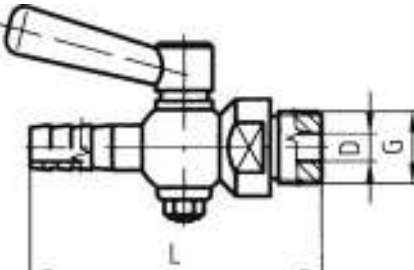
ПРОБООТБОРНИК	53020	РАЗМЕРЫ										резьб DIN 405 Rd x s	кг
		DN	A	B	C	D	E	F	G	L			
		4				4			1/4"				0,290
		6				6			3/8"				0,300
		8				8			1/2"				0,320
		12				12			3/4"				0,420

ПРОБООТБОРНИК ПОД ШЛАНГ	53030	РАЗМЕРЫ										резьб DIN 405 Rd x s	кг
		DN	A	B	C	D	E	F	G	L			
		4				4			1/4"	64			0,300
		6				6			3/8"	73			0,325
		8				8			1/2"	85			0,325
		12				12			3/4"	105			0,490

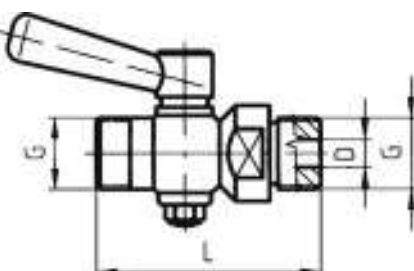
ПРОБООТБОРНИК НР-НР	53040	РАЗМЕРЫ										резьб DIN 405 Rd x s	кг
		DN	A	B	C	D	E	F	G	L			
		4				4			1/4"	53			0,310
		6				6			3/8"	61			0,332
		8				8			1/2"	75			0,332
		12				12			3/4"	86			0,502

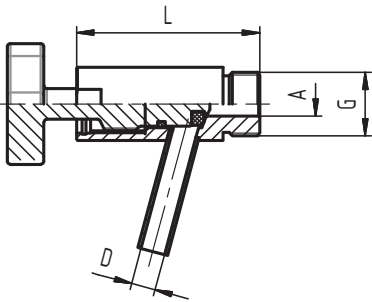
ПРОБООТБОРНИК	5305A		РАЗМЕРЫ									
	DN	A	B	C	D	E	F	G	L	резьб DIN 405 Rd x s	кг	
	1/2"	8			8			1/2"	60		0,2	

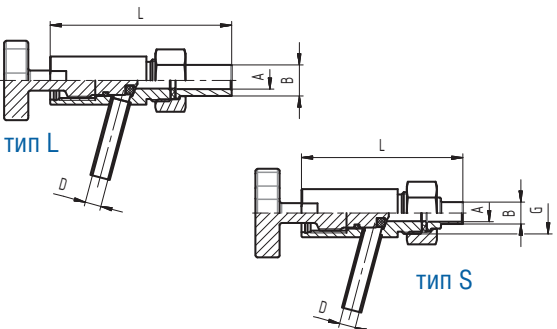
ПРОБООТБОРНИК	5305B-L		РАЗМЕРЫ									
	DN	A	B	C	D	E	F	G	L	резьб DIN 405 Rd x s	кг	
	5305B-L – длинный св рочный конус											
	1/2"	8	15,5		8			1/2"	90,5		0,2	
5305B-S – короткий св рочный конус												
1/2"	8	11		8			1/2"	80,5		0,2		

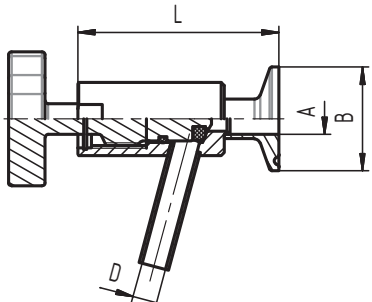
ПРОБООТБОРНИК КЛАМП	5305C		РАЗМЕРЫ									
	DN	A	B	C	D	E	F	G	L	резьб DIN 405 Rd x s	кг	
	10	10	34		8				66		0,2	
	15	16	34		8				66		0,2	
	20	20	34		8				66		0,2	
	25	26	50,5		8				69,5		0,2	

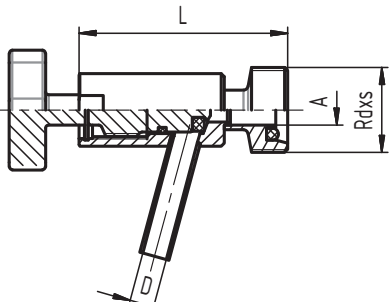
ПРОБООТБОРНИК РЕЗЬБА DIN	5305D		РАЗМЕРЫ									
	DN	A	B	C	D	E	F	G	L	резьб DIN 405 Rd x s	кг	
	10	10			8				69	28x1/8	0,2	
	15	16			8				69	34x1/8	0,2	
	20	20			8				72	44x1/6	0,2	
	25	26			8				77	52x1/6	0,2	

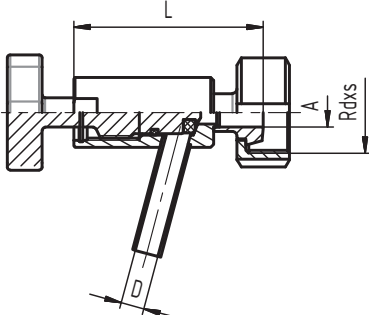
ПРОБООТБОРНИК ГАЙКА DIN	5305E	РАЗМЕРЫ										
		DN	A	B	C	D	E	F	G	L	резьб DIN 405 Rd x s	кг
		10	10			8				65	28x1/8	0,2
		15	16			8				65	34x1/8	0,2
		20	20			8				66	44x1/6	0,2
		25	26			8				70	52x1/6	0,2

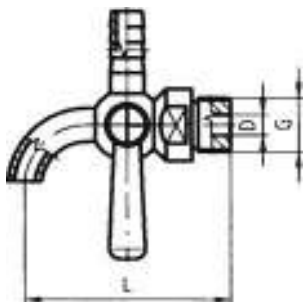
НИЖНИЙ КРАН УРОВНЕМЕРА ДЛЯ PVC-ТРУБКИ	53080	РАЗМЕРЫ										
		DN	A	B	C	D	E	F	G	L	резьб DIN 405 Rd x s	кг
		8				8			1/2"	80		0,37
		12				12			3/4"	133		

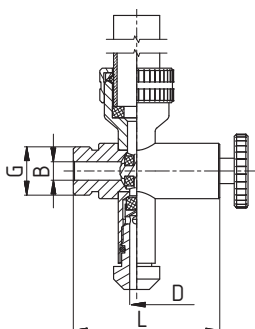
НИЖНИЙ КРАН ДЛЯ УРОВНЕМЕРА	5309A	РАЗМЕРЫ											
		5 б р	DN	A	B	C	D	E	F	G	L	резьб DIN 405 Rd x s	кг
			1/2"		8		6			1/2"	63,5		

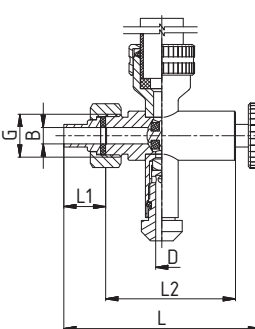
НИЖНИЙ КРАН ДЛЯ УРОВНЕМЕРА	5309B	РАЗМЕРЫ											
		5 б р	DN	A	B	C	D	E	G	L1	L2	резьб DIN 405 Rd x s	кг
			8		8		6		1/2"	20,5	63,5		

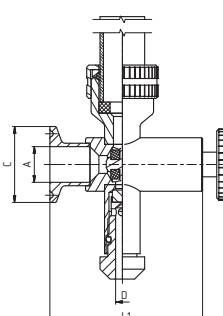
НИЖНИЙ КРАН ДЛЯ УРОВНЕМЕРА, КЛАМП	5309C		РАЗМЕРЫ										
	5 б р		DN	A	B	C	D	E	F	G	L1	резьб DIN 405 Rd x s	кг
		10	10		34	6					68,5		
		15	16		34	6					68,5		
		20	20		34	6					38,5		
		25	26		50,5	6					76		

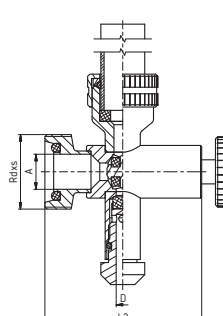
НИЖНИЙ КРАН ДЛЯ УРОВНЕМЕРА, РЕЗЬБА DIN	5309D		РАЗМЕРЫ										
	5 б р		DN	A	B	C	D	E	F	G	L2	резьб DIN 405 Rd x s	кг
		10	10			6					71,5	28x1/8"	
		15	16			6					71,5	34x1/8"	
		20	20			6					74,5	44x1/6"	
		25	26			6					85,5	52x1/6"	

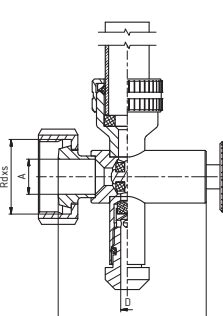
НИЖНИЙ КРАН ДЛЯ УРОВНЕМЕРА, ГАЙКА DIN	5309E		РАЗМЕРЫ										
	5 б р		DN	A	B	C	D	E	F	G	L3	резьб DIN 405 Rd x s	кг
		10	10			6					67,5	28x1/8"	
		15	16			6					67,5	34x1/8"	
		20	20			6					68,5	44x1/6"	
		25	26			6					81,5	52x1/6"	

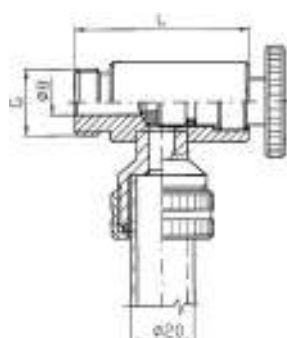
ВЕРХНИЙ КРАН ДЛЯ УРОВНЕМЕРА	5310A		РАЗМЕРЫ											
	5 б р		DN	A	B	C	D	E	F	G	L	резьб DIN 405 Rd x s	кг	
		1/2"				8				1/2"	63,5			

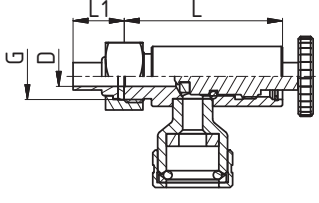
ВЕРХНИЙ КРАН ДЛЯ УРОВНЕМЕРА	5310B		РАЗМЕРЫ									
	5 б р		DN	D	G	L	L1	E	F	R	резьб DIN 405 Rd x s	кг
			8	8	1/2"	63,4	20,5					

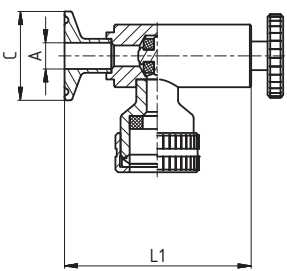
ВЕРХНИЙ КРАН ДЛЯ УРОВНЕМЕРА, КЛАМП	5310C		РАЗМЕРЫ									
	5 б р		DN	A	C	D	L1	E	F	R	L	резьб DIN 405 Rd x s
			10	10	34	6	68,5					
			15	16	34	6	68,5					
			20	20	34	6	68,5					
			25	26	50,5	6	76					

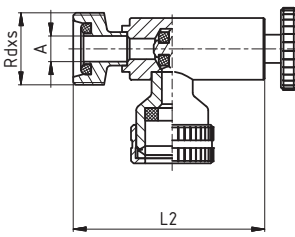
ВЕРХНИЙ КРАН ДЛЯ УРОВНЕМЕРА, РЕЗЬБА DIN	5310D		РАЗМЕРЫ										
	5 б р		DN	A	B	C	D	E	F	R	L	резьб DIN 405 Rd x s	кг
			10	10	6	71,5						28x1/8"	
			15	16	6	71,5							34x1/8"
			20	20	6	74,5							44x1/6"
			25	26	6	85,5							52x1/6"

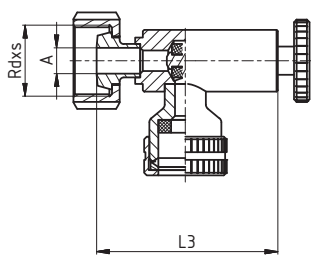
ВЕРХНИЙ КРАН ДЛЯ УРОВНЕМЕРА, ГАЙКА DIN	5310E		РАЗМЕРЫ										
	5 б р		DN	A	B	C	D	E	F	R	L	резьб DIN 405 Rd x s	кг
			10	10	6	67,5						28x1/8"	
			15	16	6	67,5							34x1/8"
			20	20	6	68,5							44x1/6"
			25	26	6	81,5							52x1/6"

УРОВНЕМЕР В СБОРЕ
5311B
РАЗМЕРЫ

DN	H, м	Длин крышки, мм	Длин стекл, мм
Уровнемер 5 б р			
	1,0	62	56
	1,5	62	56
	2,0	62	56
	2,5	62	56
	3,0	62	56
Уровнемер 10 б р			
	1,0	82	56
	1,5	82	56
	2,0	82	56
	2,5	82	56
	3,0	82	56

Другие длины по з просу

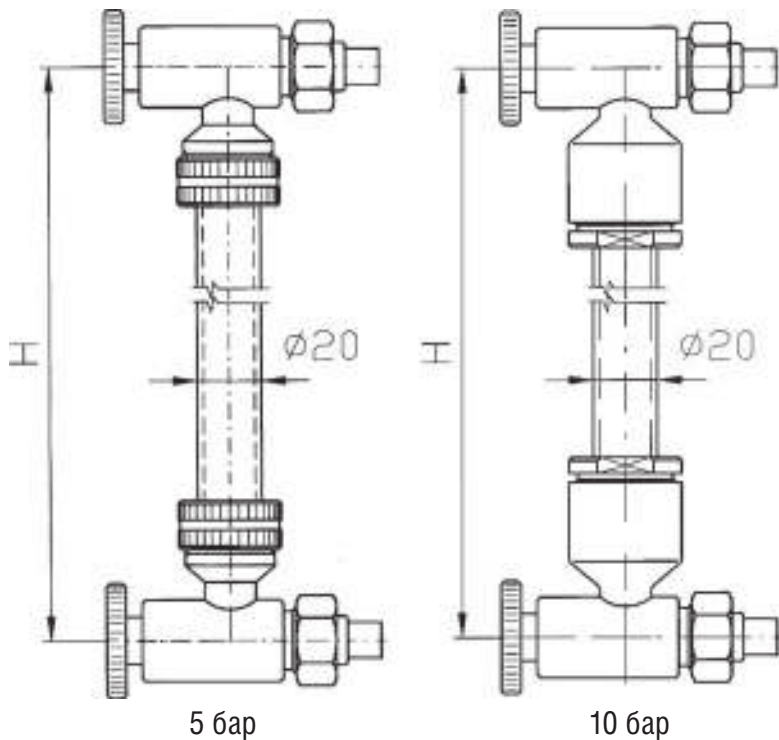
УРОВНЕМЕР В СБОРЕ С ПРОБООТБОРНЫМ КРАНОМ
5312B
РАЗМЕРЫ

DN	H, м	Длин крышки, мм	Длин стекл, мм
Уровнемер 5 б р			
	1,0	62	56
	1,5	62	56
	2,0	62	56
	2,5	62	56
	3,0	62	56
Уровнемер 10 б р			
	1,0	82	56
	1,5	82	56
	2,0	82	56
	2,5	82	56
	3,0	82	56

Другие длины по з просу

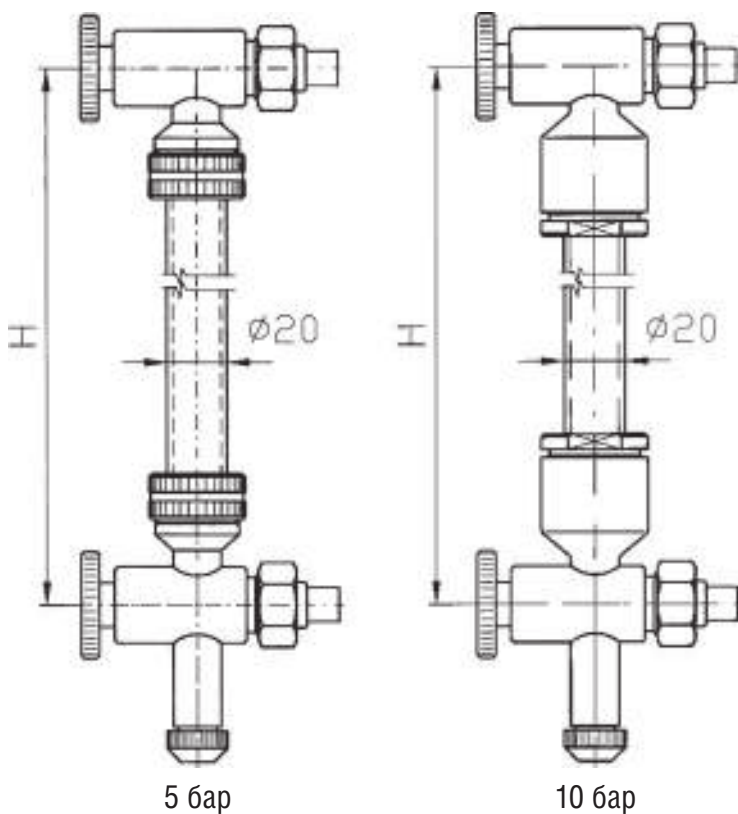

УРОВНЕМЕР В СБОРЕ КЛАМП-КЛАМП

5311C

РАЗМЕРЫ

DN	H, м	Длин крышки, мм	Длин стекл, мм
Уровнемер 5 б р			
1,0		62	56
1,5		62	56
2,0		62	56
2,5		62	56
3,0		62	56
Уровнемер 10 б р			
1,0		82	56
1,5		82	56
2,0		82	56
2,5		82	56
3,0		82	56

Другие длины по 3 просу

5 бар

10 бар

УРОВНЕМЕР В СБОРЕ С ПРОБООТБОРНЫМ КРАНОМ КЛАМП-КЛАМП

5312C

РАЗМЕРЫ

DN	H, м	Длин крышки, мм	Длин стекл, мм
Уровнемер 5 б р			
1,0		62	56
1,5		62	56
2,0		62	56
2,5		62	56
3,0		62	56
Уровнемер 10 б р			
1,0		82	56
1,5		82	56
2,0		82	56
2,5		82	56
3,0		82	56

Другие длины по 3 просу

5 бар

10 бар

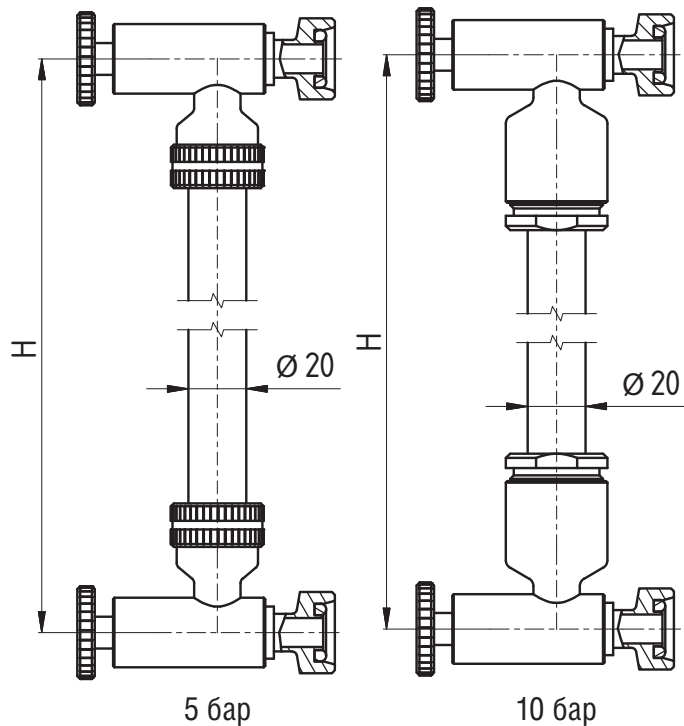
**УРОВНЕМЕР В СБОРЕ
РЕЗЬБА-РЕЗЬБА DIN**
5311D
РАЗМЕРЫ

DN	H, м	Длин крышки, мм	Длин стекл, мм
----	------	-----------------	----------------

Уровнемер 5 б р

1,0	62	56
1,5	62	56
2,0	62	56
2,5	62	56
3,0	62	56

Уровнемер 10 б р

1,0	82	56
1,5	82	56
2,0	82	56
2,5	82	56
3,0	82	56

Другие длины по з просу

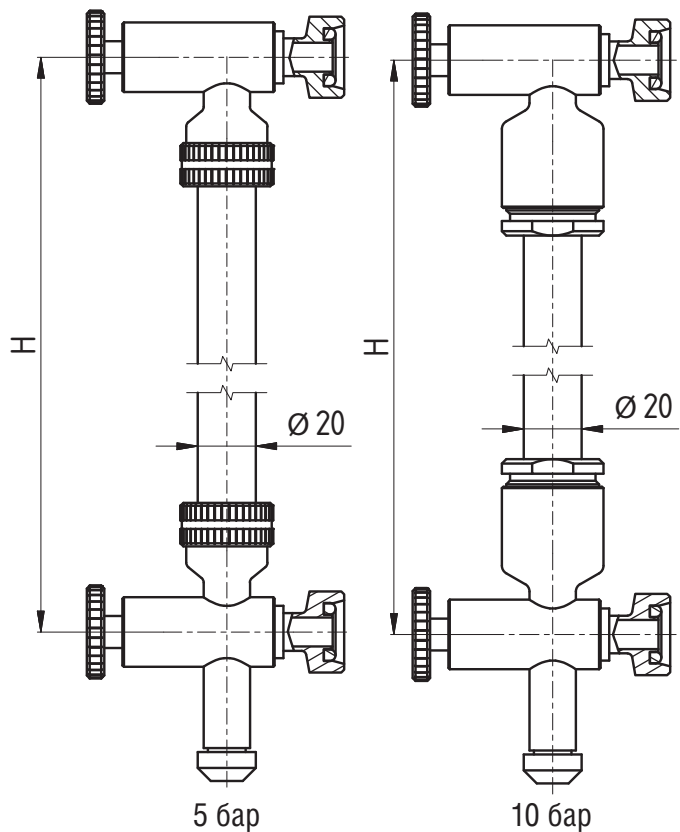
**УРОВНЕМЕР В СБОРЕ С ПРОБООТБОРНЫМ КРАНОМ
РЕЗЬБА-РЕЗЬБА DIN**
5312D
РАЗМЕРЫ

DN	H, м	Длин крышки, мм	Длин стекл, мм
----	------	-----------------	----------------

Уровнемер 5 б р

1,0	62	56
1,5	62	56
2,0	62	56
2,5	62	56
3,0	62	56

Уровнемер 10 б р

1,0	82	56
1,5	82	56
2,0	82	56
2,5	82	56
3,0	82	56

Другие длины по з просу

УРОВНЕМЕР В СБОРЕ
ГАЙКА DIN

5311E

РАЗМЕРЫ

DN	H, м	Длин крышки, мм	Длин стекл, мм
Уровнемер 5 б р			
	1,0	62	56
	1,5	62	56
	2,0	62	56
	2,5	62	56
	3,0	62	56
Уровнемер 10 б р			
	1,0	82	56
	1,5	82	56
	2,0	82	56
	2,5	82	56
	3,0	82	56

Другие длины по з просу

5 бар 10 бар

УРОВНЕМЕР В СБОРЕ С ПРОБООТБОРНЫМ КРАНОМ
ГАЙКА DIN

5312E

РАЗМЕРЫ

DN	H, м	Длин крышки, мм	Длин стекл, мм
Уровнемер 5 б р			
	1,0	62	56
	1,5	62	56
	2,0	62	56
	2,5	62	56
	3,0	62	56
Уровнемер 10 б р			
	1,0	82	56
	1,5	82	56
	2,0	82	56
	2,5	82	56
	3,0	82	56

Другие длины по з просу

5 бар 10 бар

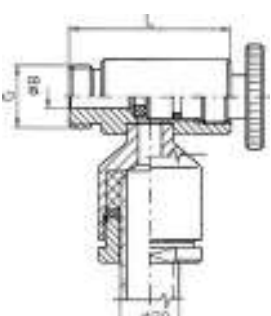
ВЕРХНИЙ КРАН ДЛЯ УРОВНЕМЕРА 10 6 p	5313A		РАЗМЕРЫ									
	DN	A	B	C	D	E	F	G	L	резьб Rd x s	DIN 405	кг
	8				8			1/2"	80			0,37
	12				12			3/4"	133			

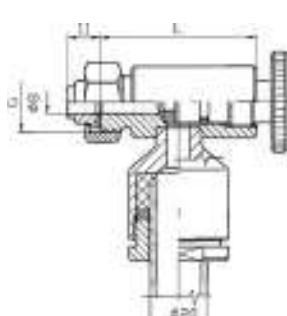
ВЕРХНИЙ КРАН ДЛЯ УРОВНЕМЕРА ГАЙКА 10 6 p	5313B		РАЗМЕРЫ									
	DN	A	B	C	D	E	G	L	L1	резьб Rd x s	DIN 405	кг
	8				8		1/2"	63,5	11			

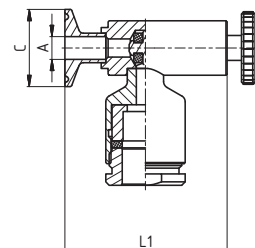
ВЕРХНИЙ КРАН ДЛЯ УРОВНЕМЕРА КЛАМП 10 6 p	5313C		РАЗМЕРЫ									
	DN	A	B	C	D	E	F	G	L1	резьб Rd x s	DIN 405	кг
	10	10		34	6				68,5			
	15	16		34	6				68,5			
	20	20		34	6				38,5			
	25	26		50,5	6				76			

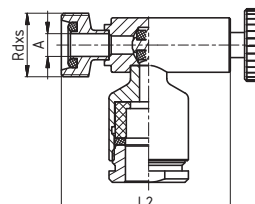
ВЕРХНИЙ КРАН ДЛЯ УРОВНЕМЕРА РЕЗЬБА DIN 10 6 p	5313D		РАЗМЕРЫ									
	DN	A	B	C	D	E	F	G	L2	резьб Rd x s	DIN 405	кг
	10	10			6				71,5		28x1/8"	
	15	16			6				71,5		34x1/8"	
	20	20			6				74,5		44x1/6"	
	25	26			6				85,5		52x1/6"	

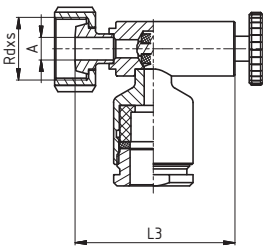
ВЕРХНИЙ КРАН ДЛЯ УРОВНЕМЕРА ГАЙКА DIN	5313E		РАЗМЕРЫ										
	10 б р		DN	A	B	C	D	E	F	G	L3	резьб DIN 405 Rd x s	кг
			10	10			6				67,5	28x1/8"	
			15	16			6				67,5	34x1/8"	
			20	20			6				68,5	44x1/6"	
			25	26			6				81,5	52x1/6"	

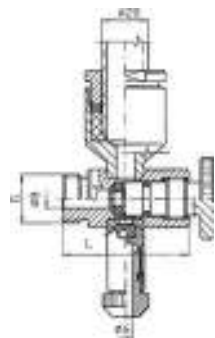
НИЖНИЙ КРАН ДЛЯ УРОВНЕМЕРА	5314A		РАЗМЕРЫ										
	10 б р		DN	A	B	d	D	E	F	G	L	резьб DIN 405 Rd x s	кг
			1/2"			6	8			1/2"	63,5		
			3/4"				8			3/4"	73		

НИЖНИЙ КРАН ДЛЯ УРОВНЕМЕРА С ПРОБООТБОРНИКОМ ГАЙКА	5314B		РАЗМЕРЫ										
	10 б р		DN	A	B	d	D	E	G	L	L1	резьб DIN 405 Rd x s	кг
			8			6	8		1/2"	63,5	11		

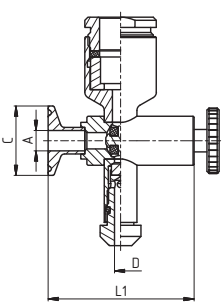
НИЖНИЙ КРАН ДЛЯ УРОВНЕМЕРА С ПРОБООТБОРНИКОМ КЛАМП	5314C		РАЗМЕРЫ										
	10 б р		DN	A	B	C	D	E	F	G	L1	резьб DIN 405 Rd x s	кг
			10	10		34	6				68,5		
			15	16		34	6				68,5		
			20	20		34	6				38,5		
			25	26		50,5	6				76		

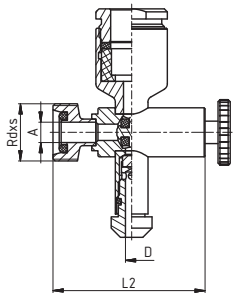
НИЖНИЙ КРАН ДЛЯ УРОВНЕМЕРА С ПРОБООТБОРНИКОМ РЕЗЬБА DIN	5314D	РАЗМЕРЫ											
	10 б р	DN	A	B	C	D	E	F	G	L2	резьб DIN 405 Rd x s	кг	
	10	10				6					71,5	28x1/8"	
	15	16				6					71,5	34x1/8"	
	20	20				6					74,5	44x1/6"	
	25	26				6					85,5	52x1/6"	

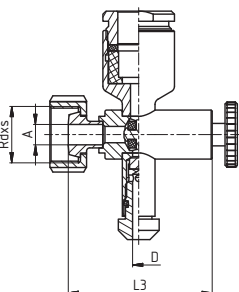
НИЖНИЙ КРАН ДЛЯ УРОВНЕМЕРА С ПРОБООТБОРНИКОМ ГАЙКА DIN	5314E	РАЗМЕРЫ											
	10 б р	DN	A	B	C	D	E	F	G	L3	резьб DIN 405 Rd x s	кг	
	10	10				6					67,5	28x1/8"	
	15	16				6					67,5	34x1/8"	
	20	20				6					68,5	44x1/6"	
	25	26				6					81,5	52x1/6"	

ТРУБКА УРОВНЕМЕРА СТЕКЛЯННАЯ	5315A	РАЗМЕРЫ											
		DN	A										кг
	20	м кс. 3000											
	Другие длины по з просу												

ТРУБКА УРОВНЕМЕРА PVC	5315B	РАЗМЕРЫ											
		DN	A										кг
 <p>для максимальной температуры 65 °C</p>	20	м кс. 5000											
	Другие длины по з просу												

ЗАЩИТНЫЙ КОЖУХ УРОВНЕМЕРА	5316A	РАЗМЕРЫ											
		DN	L										кг
		м кс. 3000											
	Другие длины по з просу												
Р счет длины кожух : уровнемер 5 б р L = H – 62 мм уровнемер 10 б р L = H – 82 мм Р состояние между кр н ми уровнемер H см. 5311B ... 5312E													

ЗАЩИТНЫЙ КОЖУХ УРОВНЕМЕРА	5316B	РАЗМЕРЫ										
	DN		L									кг
		м кс. 3000										
		Другие длины по з просу Р счет длины кожух : уровнемер 5 б р L = H – 62 мм уровнемер 10 б р L = H – 82 мм Р стояние между кр н ми уровнемер H см. 5311B ... 5312E										

МУФТА СОЕДИНИТЕЛЬНАЯ	5317A	РАЗМЕРЫ										
	5 б р		DN	A	B	C	D	E	F	R	L	резьб DIN 405 Rd x s
		32 20,5 37 12										

МУФТА СОЕДИНИТЕЛЬНАЯ	5317B	РАЗМЕРЫ										
	10 б р		DN	A	B	C	D	E	F	R	L	резьб DIN 405 Rd x s
		35 20,5 61 12										

УПЛОТНЕНИЕ ДЛЯ УРОВНЕМЕРА	72020	РАЗМЕРЫ										
	DN		A	B	C	D	E	F	R	L	резьб DIN 405 Rd x s	кг
		М тери л: NBR / EPDM / Silikon										

УПЛОТНЕНИЕ ДЛЯ УРОВНЕМЕРА	5317B-seal	РАЗМЕРЫ										
	DN		A	B	C	D	d	F	R	L	резьб DIN 405 Rd x s	кг
		30 20 17										
		0,01										

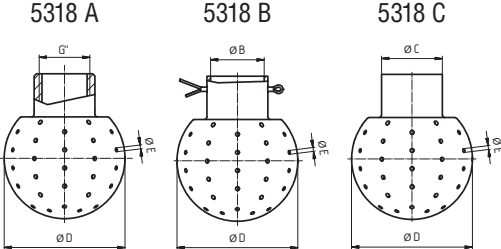
МОЮЩАЯ ГОЛОВКА 360°		53180					РАЗМЕРЫ		ДАВЛЕНИЕ 1 БАР		ДАВЛЕНИЕ 2 БАР	
		DN	D мм	B мм	C мм	G"	E мм	Скорость потока м³/ч с	Р диус омыв ния м	Скорость потока м³/ч с	Р диус омыв ния м	
 <p>5318 A 5318 B 5318 C</p> <p>муфта под шплинт под сварку</p>	28	28	12,2	12	1/4"-1/2"	1,3	1,86	0,62	2,64	1,23		
	40	40	22,2	22	1/2"-3/4"	1,3	5,13	2,84	7,26	5,68		
	50	50	22,2	22	1/2"-3/4"	1,6	5,59	1,53	7,91	3,07		
	50	50	28,2	28	1/2"-3/4"	1,6	7,26	2,59	10,26	5,18		
	65	50	28,2	28	3/4"-1"	1,6	8,77	2,04	12,4	4,09		
	65	65	34,3	34	3/4"-1"	1,6	7,9	1,66	11,18	3,33		
	65	65	40,5	40	3/4"-1"	1,6	10,54	3,64	14,91	7,19		
	90	90	40,5	40	1 1/4"	2,5	31,62	2,08	44,72	4,17		
	90	90	52,3	52	1 1/4"	2,5	31,62	2,08	44,72	4,17		

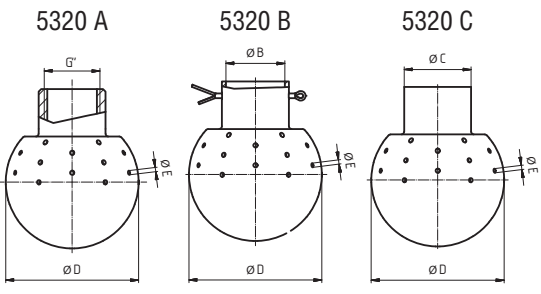
МОЮЩАЯ ГОЛОВКА 180°		53200					РАЗМЕРЫ		ДАВЛЕНИЕ 1 БАР		ДАВЛЕНИЕ 2 БАР	
		DN	D мм	B мм	C мм	G"	E мм	Скорость потока м³/ч с	Р диус омыв ния м	Скорость потока м³/ч с	Р диус омыв ния м	
 <p>5320 A 5320 B 5320 C</p> <p>муфта под шплинт под сварку</p>	28	28	12,2	12	1/4"-1/2"	1,3	1,21	1	1,71	2,01		
	40	40	22,2	22	1/2"-3/4"	1,3	3,03	3,88	4,28	7,75		
	50	50	22,2	22	1/2"-3/4"	1,6	3,47	2,12	4,91	4,64		
	50	50	28,2	28	1/2"-3/4"	1,6	4,71	4,28	6,67	8,55		
	65	65	28,2	28	3/4"-1"	1,6	5,35	2,99	7,56	5,98		
	65	65	34,3	34	3/4"-1"	1,6	6,46	5,37	5,98	3,74		
	65	65	40,5	40	3/4"-1"	1,6	5,87	4,44	8,31	8,88		
	90	90	40,5	40	1 1/4"	2,5	12,91	1,38	18,26	2,75		

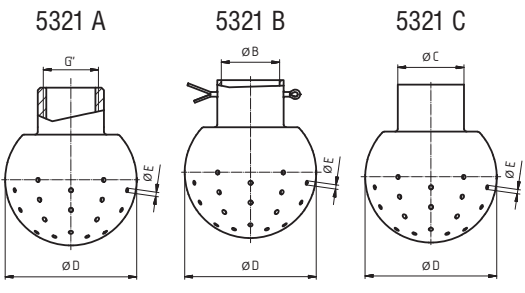
МОЮЩАЯ ГОЛОВКА 180°		53210					РАЗМЕРЫ		ДАВЛЕНИЕ 1 БАР		ДАВЛЕНИЕ 2 БАР	
		DN	D мм	B мм	C мм	G"	E мм	Скорость потока м³/ч с	Р диус омыв ния м	Скорость потока м³/ч с	Р диус омыв ния м	
 <p>5321 A 5321 B 5321 C</p> <p>муфта под шплинт под сварку</p>	28	28	12,2	12	1/4"-1/2"	1,3	1,21	1	1,71	2,01		
	40	40	22,2	22	1/2"-3/4"	1,3	3,03	3,88	4,28	7,75		
	50	50	22,2	22	1/2"-3/4"	1,6	3,47	2,12	4,91	4,64		
	50	50	28,2	28	1/2"-3/4"	1,6	4,71	4,28	6,67	8,55		
	65	65	28,2	28	3/4"-1"	1,6	5,35	2,99	7,56	5,98		
	65	65	34,3	34	3/4"-1"	1,6	6,46	5,37	5,98	3,74		
	65	65	40,5	40	3/4"-1"	1,6	5,87	4,44	8,31	8,88		
	90	90	40,5	40	1 1/4"	2,5	12,91	1,38	18,26	2,75		

МОЮЩАЯ ГОЛОВКА РОТАЦИОННАЯ		5322				ХАРАКТЕРИСТИКИ																																																				
5322A	5322B	5322C			<table border="1"> <tr> <td>М тери лы</td> <td></td> </tr> <tr> <td>Корпус</td> <td>AISI 316L (1.4404)</td> </tr> <tr> <td>Ш рики</td> <td>AISI 316L (1.4404) / PTFE</td> </tr> <tr> <td>Ост льные дет ли</td> <td>AISI 316 L</td> </tr> <tr> <td>Темпер тур</td> <td></td> </tr> <tr> <td>М кс. р боч я темпер тур</td> <td>230 °C</td> </tr> <tr> <td>М кс. темпер тур окружения</td> <td>140 °C</td> </tr> </table>		М тери лы		Корпус	AISI 316L (1.4404)	Ш рики	AISI 316L (1.4404) / PTFE	Ост льные дет ли	AISI 316 L	Темпер тур		М кс. р боч я темпер тур	230 °C	М кс. темпер тур окружения	140 °C																																						
М тери лы																																																										
Корпус	AISI 316L (1.4404)																																																									
Ш рики	AISI 316L (1.4404) / PTFE																																																									
Ост льные дет ли	AISI 316 L																																																									
Темпер тур																																																										
М кс. р боч я темпер тур	230 °C																																																									
М кс. темпер тур окружения	140 °C																																																									
<table border="1"> <tr> <td>РАЗМЕРЫ</td> <td>DN</td> <td>A</td> <td>B</td> <td>D</td> <td>G</td> </tr> <tr> <td>5322A</td> <td>45</td> <td></td> <td></td> <td>45</td> <td>3/4"</td> </tr> <tr> <td>5322B</td> <td>45</td> <td>28,5</td> <td></td> <td>45</td> <td></td> </tr> <tr> <td>5322B</td> <td>45</td> <td>29,5</td> <td></td> <td>45</td> <td></td> </tr> <tr> <td>5322C</td> <td>45</td> <td>28</td> <td>25</td> <td>45</td> <td></td> </tr> <tr> <td>5322C</td> <td>45</td> <td>29</td> <td>26</td> <td>45</td> <td></td> </tr> </table>			РАЗМЕРЫ	DN	A	B	D	G	5322A	45			45	3/4"	5322B	45	28,5		45		5322B	45	29,5		45		5322C	45	28	25	45		5322C	45	29	26	45		<table border="1"> <tr> <td>Д вление</td> <td></td> </tr> <tr> <td>Р бочее д вление</td> <td>1-3 б р</td> </tr> <tr> <td>Рекомендов нное д вление</td> <td>2 б р</td> </tr> <tr> <td>См чив ние</td> <td>м кс. 3 м</td> </tr> <tr> <td>Р диус омыв ния</td> <td>1,4 м</td> </tr> <tr> <td>Присоединение</td> <td></td> </tr> <tr> <td>5322A</td> <td>резьб G 3/4"</td> </tr> <tr> <td>5322B</td> <td>шплинт</td> </tr> <tr> <td>5322C</td> <td>св рк</td> </tr> </table>		Д вление		Р бочее д вление	1-3 б р	Рекомендов нное д вление	2 б р	См чив ние	м кс. 3 м	Р диус омыв ния	1,4 м	Присоединение		5322A	резьб G 3/4"	5322B	шплинт	5322C	св рк
РАЗМЕРЫ	DN	A	B	D	G																																																					
5322A	45			45	3/4"																																																					
5322B	45	28,5		45																																																						
5322B	45	29,5		45																																																						
5322C	45	28	25	45																																																						
5322C	45	29	26	45																																																						
Д вление																																																										
Р бочее д вление	1-3 б р																																																									
Рекомендов нное д вление	2 б р																																																									
См чив ние	м кс. 3 м																																																									
Р диус омыв ния	1,4 м																																																									
Присоединение																																																										
5322A	резьб G 3/4"																																																									
5322B	шплинт																																																									
5322C	св рк																																																									

МОЮЩАЯ ГОЛОВКА РОТАЦИОННАЯ		5323				ХАРАКТЕРИСТИКИ																																																				
5323A	5323B	5323C			<table border="1"> <tr> <td>М тери лы</td> <td></td> </tr> <tr> <td>Корпус</td> <td>AISI 316L (1.4404)</td> </tr> <tr> <td>Ш рики</td> <td>AISI 316L (1.4404) / PTFE</td> </tr> <tr> <td>Ост льные дет ли</td> <td>AISI 316 L</td> </tr> <tr> <td>Темпер тур</td> <td></td> </tr> <tr> <td>М кс. р боч я темпер тур</td> <td>230 °C</td> </tr> <tr> <td>М кс. темпер тур окружения</td> <td>140 °C</td> </tr> </table>		М тери лы		Корпус	AISI 316L (1.4404)	Ш рики	AISI 316L (1.4404) / PTFE	Ост льные дет ли	AISI 316 L	Темпер тур		М кс. р боч я темпер тур	230 °C	М кс. темпер тур окружения	140 °C																																						
М тери лы																																																										
Корпус	AISI 316L (1.4404)																																																									
Ш рики	AISI 316L (1.4404) / PTFE																																																									
Ост льные дет ли	AISI 316 L																																																									
Темпер тур																																																										
М кс. р боч я темпер тур	230 °C																																																									
М кс. темпер тур окружения	140 °C																																																									
<table border="1"> <tr> <td>РАЗМЕРЫ</td> <td>DN</td> <td>A</td> <td>B</td> <td>D</td> <td>G</td> </tr> <tr> <td>5323A</td> <td>65</td> <td></td> <td></td> <td>65</td> <td>1 1/4"</td> </tr> <tr> <td>5323B</td> <td>65</td> <td>40,5</td> <td></td> <td>65</td> <td></td> </tr> <tr> <td>5323B</td> <td>65</td> <td>41,5</td> <td></td> <td>65</td> <td></td> </tr> <tr> <td>5323C</td> <td>65</td> <td>40</td> <td>37</td> <td>65</td> <td></td> </tr> <tr> <td>5323C</td> <td>65</td> <td>41</td> <td>38</td> <td>65</td> <td></td> </tr> </table>			РАЗМЕРЫ	DN	A	B	D	G	5323A	65			65	1 1/4"	5323B	65	40,5		65		5323B	65	41,5		65		5323C	65	40	37	65		5323C	65	41	38	65		<table border="1"> <tr> <td>Д вление</td> <td></td> </tr> <tr> <td>Р бочее д вление</td> <td>1-3 б р</td> </tr> <tr> <td>Рекомендов нное д вление</td> <td>2 б р</td> </tr> <tr> <td>См чив ние</td> <td>м кс. 3 м</td> </tr> <tr> <td>Р диус омыв ния</td> <td>2 м</td> </tr> <tr> <td>Присоединение</td> <td></td> </tr> <tr> <td>5323A</td> <td>резьб G 1 1/4"</td> </tr> <tr> <td>5323B</td> <td>шплинт</td> </tr> <tr> <td>5323C</td> <td>св рк</td> </tr> </table>		Д вление		Р бочее д вление	1-3 б р	Рекомендов нное д вление	2 б р	См чив ние	м кс. 3 м	Р диус омыв ния	2 м	Присоединение		5323A	резьб G 1 1/4"	5323B	шплинт	5323C	св рк
РАЗМЕРЫ	DN	A	B	D	G																																																					
5323A	65			65	1 1/4"																																																					
5323B	65	40,5		65																																																						
5323B	65	41,5		65																																																						
5323C	65	40	37	65																																																						
5323C	65	41	38	65																																																						
Д вление																																																										
Р бочее д вление	1-3 б р																																																									
Рекомендов нное д вление	2 б р																																																									
См чив ние	м кс. 3 м																																																									
Р диус омыв ния	2 м																																																									
Присоединение																																																										
5323A	резьб G 1 1/4"																																																									
5323B	шплинт																																																									
5323C	св рк																																																									

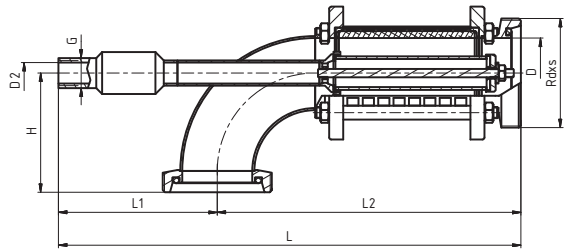
НАСЫТИТЕЛЬНАЯ СВЕЧА 90° РЕЗЬБА-РЕЗЬБА	53300	РАЗМЕРЫ								
		DN	D	D2	H	L	L1	L2	G	Rd x s
	25	26	9	65	255	85	170	G 1/4"	52x1/6"	1,5
	32	32	9	87	265	90	175	G 1/4"	58x1/6"	1,75
	40	38	9	87	280	90	190	G 1/4"	65x1/6"	2
	50	50	16	90	320	100	220	G 1/2"	78x1/6"	2,45
	65	66	16	97	343	110	233	G 1/2"	95x1/6"	3,6
	80	81	16	109	392	114	278	G 1/2"	110x1/4"	4,5

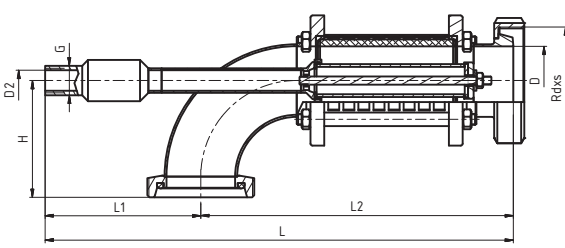
НАСЫТИТЕЛЬНАЯ СВЕЧА 90° РЕЗЬБА-ГАЙКА	53301	РАЗМЕРЫ								
		DN	D	D2	H	L	L1	L2	G	Rd x s
	25	26	9	65				G 1/4"	52x1/6"	1,5
	32	32	9	87				G 1/4"	58x1/6"	1,75
	40	38	9	87				G 1/4"	65x1/6"	2
	50	50	16	90				G 1/2"	78x1/6"	2,45
	65	66	16	97				G 1/2"	95x1/6"	3,6
	80	81	16	109				G 1/2"	110x1/4"	4,5

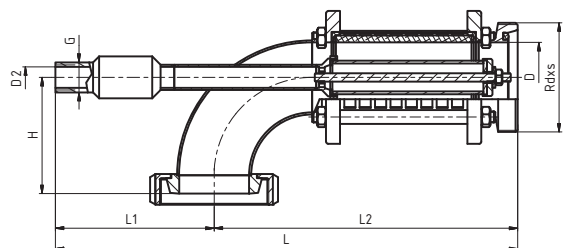
НАСЫТИТЕЛЬНАЯ СВЕЧА 90° ГАЙКА-РЕЗЬБА	53302	РАЗМЕРЫ								
		DN	D	D2	H	L	L1	L2	G	Rd x s
	25	26	9		255	85	170	G 1/4"	52x1/6"	1,5
	32	32	9		265	90	175	G 1/4"	58x1/6"	1,75
	40	38	9		280	90	190	G 1/4"	65x1/6"	2
	50	50	16		320	100	220	G 1/2"	78x1/6"	2,45
	65	66	16		343	110	233	G 1/2"	95x1/6"	3,6
	80	81	16		392	114	278	G 1/2"	110x1/4"	4,5

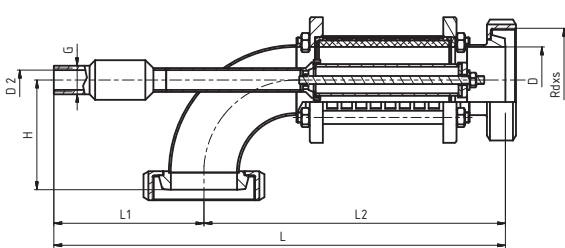
НАСЫТИТЕЛЬНАЯ СВЕЧА 90° ГАЙКА-ГАЙКА	53303	РАЗМЕРЫ								
		DN	D	D2	H	L	L1	L2	G	Rd x s
	25	26	9					G 1/4"	52x1/6"	1,5
	32	32	9					G 1/4"	58x1/6"	1,75
	40	38	9					G 1/4"	65x1/6"	2
	50	50	16					G 1/2"	78x1/6"	2,45
	65	66	16					G 1/2"	95x1/6"	3,6
	80	81	16					G 1/2"	110x1/4"	4,5

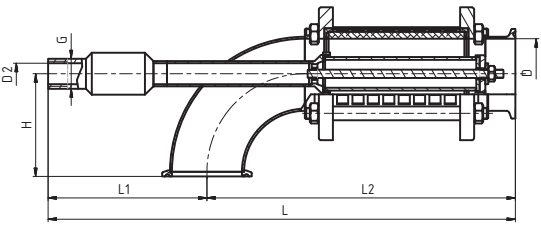
НАСЫТИТЕЛЬНАЯ СВЕЧА 90° КЛАМП-КЛАМП	53304	РАЗМЕРЫ									
		DN	D	D2	H	L	L1	L2	G	Rd x s	кг
	25	26	9					G 1/4"	52x1/6"	1,5	
	32	32	9					G 1/4"	58x1/6"	1,75	
	40	38	9					G 1/4"	65x1/6"	2	
	50	50	16					G 1/2"	78x1/6"	2,45	
	65	66	16					G 1/2"	95x1/6"	3,6	
	80	81	16					G 1/2"	110x1/4"	4,5	

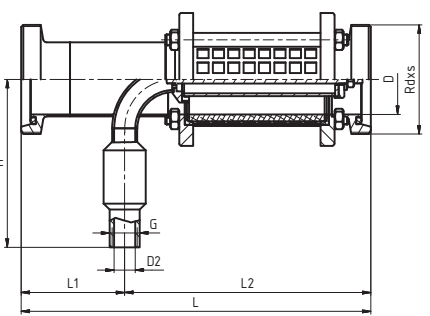
НАСЫТИТЕЛЬНАЯ СВЕЧА ПРЯМАЯ РЕЗЬБА-РЕЗЬБА	53305	РАЗМЕРЫ									
		DN	D	D2	H	L	L1	L2	G	Rd x s	кг
	25	26	9	121	231	62	169	G 1/4"	52x1/6"	1,5	
	32	32	9	121	235	66	169	G 1/4"	58x1/6"	1,75	
	40	38	9	121	216	47	169	G 1/4"	65x1/6"	2	
	50	50	16	132	255	60	195	G 1/2"	78x1/6"	2,45	
	65	66	16	132	265	65	200	G 1/2"	95x1/6"	3,6	
	80	81	16	132	301	83	218	G 1/2"	110x1/4"	4,5	

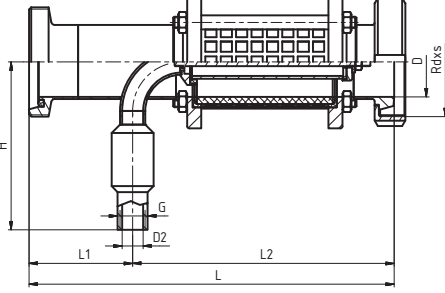
НАСЫТИТЕЛЬНАЯ СВЕЧА ПРЯМАЯ РЕЗЬБА-ГАЙКА	53306	РАЗМЕРЫ									
		DN	D	D2	H	L	L1	L2	G	Rd x s	кг
	25	26	9	121				G 1/4"	52x1/6"	1,5	
	32	32	9	121				G 1/4"	58x1/6"	1,75	
	40	38	9	121				G 1/4"	65x1/6"	2	
	50	50	16	132				G 1/2"	78x1/6"	2,45	
	65	66	16	132				G 1/2"	95x1/6"	3,6	
	80	81	16	132				G 1/2"	110x1/4"	4,5	

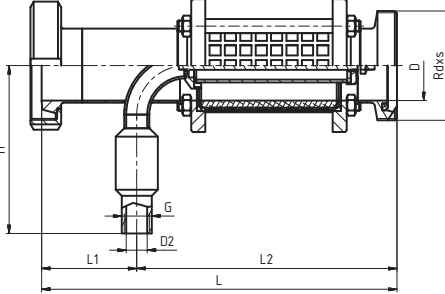
НАСЫТИТЕЛЬНАЯ СВЕЧА ПРЯМАЯ ГАЙКА-РЕЗЬБА	53307	РАЗМЕРЫ									
		DN	D	D2	H	L	L1	L2	G	Rd x s	кг
	25	26	9	121				G 1/4"	52x1/6"	1,5	
	32	32	9	121				G 1/4"	58x1/6"	1,75	
	40	38	9	121				G 1/4"	65x1/6"	2	
	50	50	16	132				G 1/2"	78x1/6"	2,45	
	65	66	16	132				G 1/2"	95x1/6"	3,6	
	80	81	16	132				G 1/2"	110x1/4"	4,5	

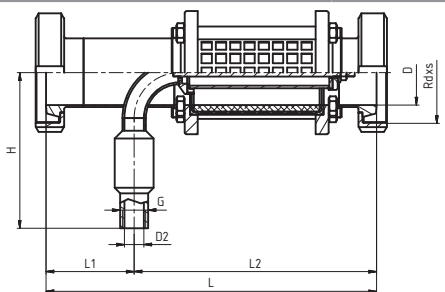
НАСЫТИТЕЛЬНАЯ СВЕЧА ПРЯМАЯ ГАЙКА-ГАЙКА	53308	РАЗМЕРЫ									
		DN	D	D2	H	L	L1	L2	G	Rd x s	кг
	25	26	9	121				G 1/4"	52x1/6"	1,5	
	32	32	9	121				G 1/4"	58x1/6"	1,75	
	40	38	9	121				G 1/4"	65x1/6"	2	
	50	50	16	132				G 1/2"	78x1/6"	2,45	
	65	66	16	132				G 1/2"	95x1/6"	3,6	
	80	81	16	132				G 1/2"	110x1/4"	4,5	

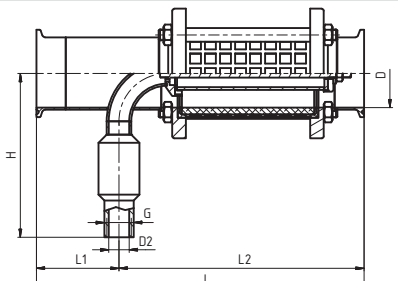
НАСЫТИТЕЛЬНАЯ СВЕЧА ПРЯМАЯ КЛАМП-КЛАМП	53309	РАЗМЕРЫ									
		DN	D	D2	H	L	L1	L2	G	Rd x s	кг
	25	26	9	121				G 1/4"	52x1/6"	1,5	
	32	32	9	121				G 1/4"	58x1/6"	1,75	
	40	38	9	121				G 1/4"	65x1/6"	2	
	50	50	16	132				G 1/2"	78x1/6"	2,45	
	65	66	16	132				G 1/2"	95x1/6"	3,6	
	80	81	16	132				G 1/2"	110x1/4"	4,5	

РАСПЫЛИТЕЛЬ	5330T	РАЗМЕРЫ										
		DN	A	B	C	D	E	F	R	L	резьб. DIN 405 Rd x s	кг
	25-40											
	50-65											
	80-100											
5330T-V	5330T-K	5330T-S	5330T-V Труб из нерж вующей ст ли, просверленн я 5330T-K Кер мик 5330T-S Спеченн я ст ль									

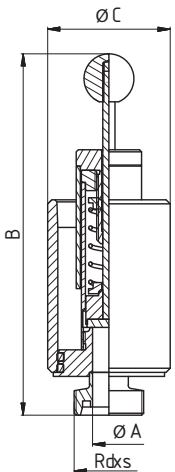
ШПУНТАППАРАТ С НИЖНИМ СОЕДИНЕНИЕМ, РЕЗЬБА	53315	РАЗМЕРЫ										
		DN	A	B	C	D	E	F	R	L	резьб. DIN 405 Rd x s	кг
	15-180	16	177	60							34x1/8"	0,77
	20-500	20	189,5	75							44x1/6"	1,21
	32-1000	32	241	110							58x1/6"	2,79

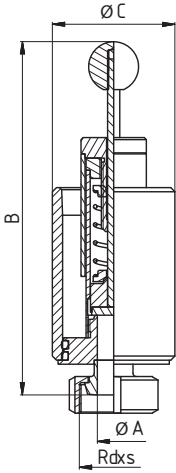
ШПУНТАППАРАТ С НИЖНИМ СОЕДИНЕНИЕМ, ГАЙКА	53316 РАЗМЕРЫ					
	DN	A	B	C	Rd x s	кг
	15-180	16	173	60	34x1/8"	0,84
	20-500	20	183,5	75	44x1/6"	1,29
	32-1000	32	234	110	58x1/6"	2,95

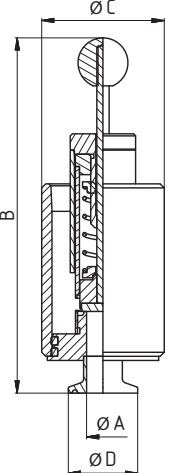
ШПУНТАППАРАТ С НИЖНИМ СОЕДИНЕНИЕМ, КЛАМП	53317 РАЗМЕРЫ					
	DN	A	B	C	D	кг
	15-180	16	174	60	34	0,75
	20-500	20	183,5	75	34	1,12
	32-1000	32	230,5	110	50,5	2,68

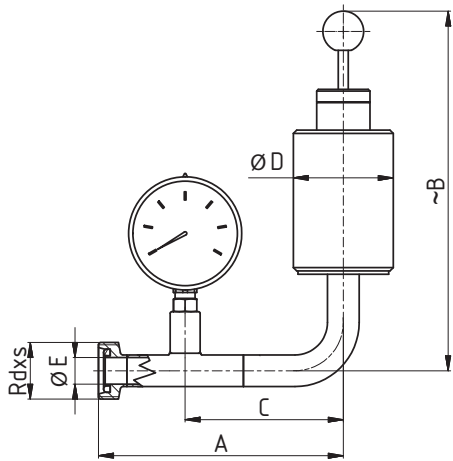
ШПУНТАППАРАТ С МАНОМЕТРОМ РЕЗЬБА	53320 РАЗМЕРЫ										
	DN	A	B	C	D	E	F	L	резьб	DIN 405	кг
	15-180 hl	147	216	95	60	16				34x1/8"	1,01
	20-180 hl	150	216	95	60	20				44x1/6"	1,01
	25-180 hl	155	216	95	60	26				52x1/6"	1,01
	20-500 hl	164	230,5	105	75	20				44x1/6"	1,48
	25-500 hl	169	230,5	105	75	26				52x1/6"	1,48
	32-1000 hl	220	287	133	110	32				58x1/6"	3,22

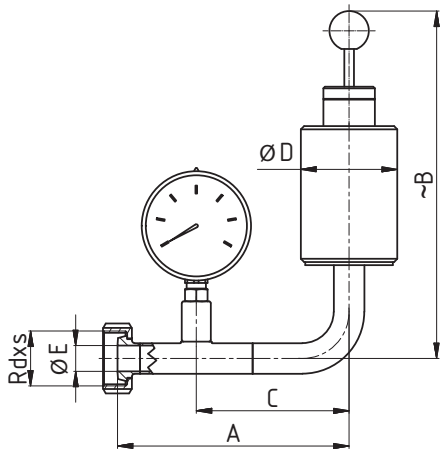
ШПУНТАППАРАТ С МАНОМЕТРОМ ГАЙКА	53321 РАЗМЕРЫ										
	DN	A	B	C	D	E	F	L	резьб	DIN 405	кг
	15-180 hl	144	216	95	60	16				34x1/8"	1,07
	20-180 hl	145	216	95	60	20				44x1/6"	1,07
	25-180 hl	150	216	95	60	26				52x1/6"	1,07
	20-500 hl	161	230,5	105	75	20				44x1/6"	1,56
	25-500 hl	166	230,5	105	75	26				52x1/6"	1,56
	32-1000 hl	209,5	287	133	110	32				58x1/6"	3,38

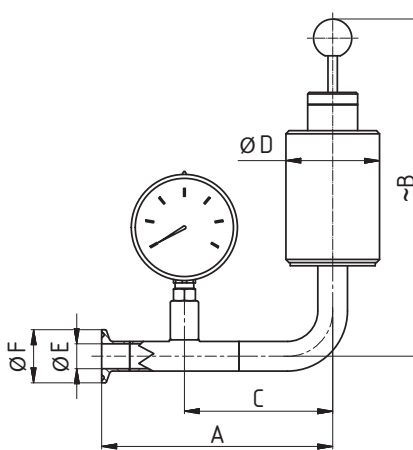
ШПУНТАППАРАТ С МАНОМЕТРОМ КЛАМП	53322	РАЗМЕРЫ									
		DN	A	B	C	D	E	F	L	резьб DIN 405 Rd x s	кг
	15-180 hl	148	216	95	60	16	34				0,98
	20-180 hl	148	216	95	60	20	50,5				0,98
	25-180 hl	151,5	216	95	60	26	50,5				0,98
	20-500 hl	163	230,5	105	75	20	50,5				1,41
	25-500 hl	166,5	230,5	105	75	26	50,5				1,41
	32-1000 hl	209,5	287	133	110	32	50,5				3,11

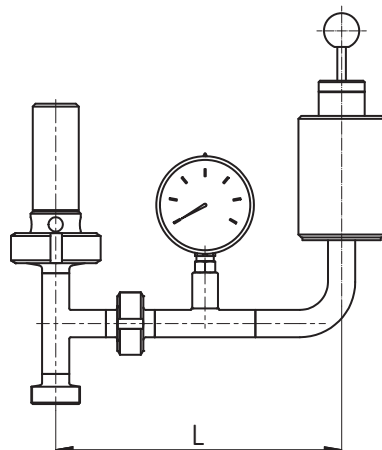
ШПУНТАППАРАТ С МАНОМЕТРОМ И ВАКУУМНЫМ КЛАПАНОМ, РЕЗЬБА	53325	РАЗМЕРЫ									
		DN	A	B	C	D	E	F	R	L	кг
	15-180									199	1,85

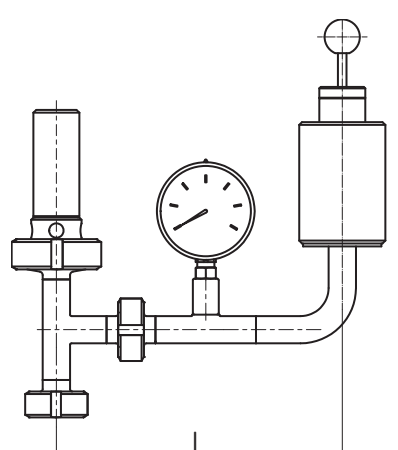
ШПУНТАППАРАТ С МАНО- МЕТРОМ И ВАКУУМНЫМ КЛАПАНОМ, ГАЙКА	53326	РАЗМЕРЫ			
		DN	L	кг	
	15-180	199	1,91		

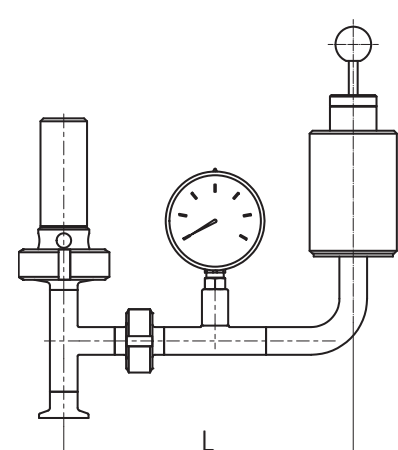
ШПУНТАППАРАТ С МАНО- МЕТРОМ И ВАКУУМНЫМ КЛАПАНОМ, КЛАМП	53327	РАЗМЕРЫ			
		DN	L	кг	
	15-180	199	1,82		

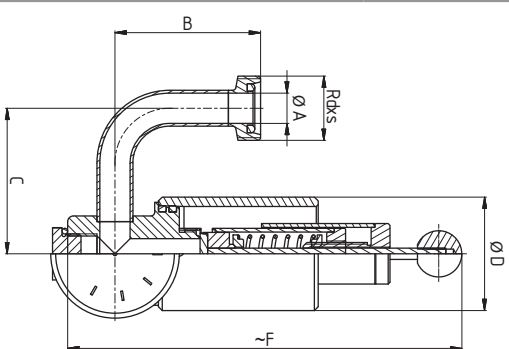
ШПУНТАППАРАТ 90° РЕЗЬБА	53330	РАЗМЕРЫ									
		DN	A	B	C	D	E	F	L	резьб DIN 405 Rd x s	кг
	15-180 hl	16	77	77	60		210			34x1/8"	1,43
	20-180 hl	20	79	77	60		210			44x1/6"	1,43
	25-180 hl	26	82	77	60		210			52x1/6"	1,43
	20-500 hl	20	84	85	75		235			44x1/6"	2,23
	25-500 hl	26	87	85	75		235			52x1/6"	2,23
	32-1000 hl	32	110	129	110		285			58x1/6"	4,11

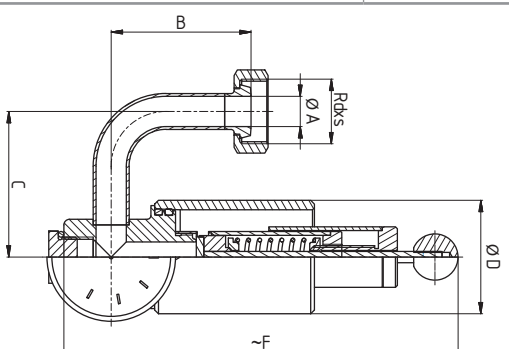
ШПУНТАППАРАТ 90° ГАЙКА	53331	РАЗМЕРЫ									
		DN	A	B	C	D	E	F	L	резьб DIN 405 Rd x s	кг
	15-180 hl	16	74	77	60		210			34x1/8"	1,57
	20-180 hl	20	76	77	60		210			44x1/6"	1,57
	25-180 hl	26	78	77	60		210			52x1/6"	1,57
	20-500 hl	20	81	85	75		235			44x1/6"	2,41
	25-500 hl	26	83	85	75		235			52x1/6"	2,41
	32-1000 hl	32	103	129	110		285			58x1/6"	4,26

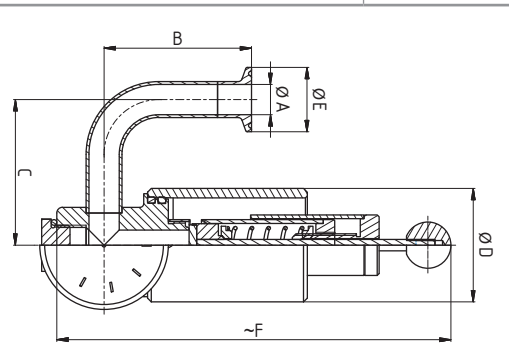
ШПУНТАППАРАТ 90° КЛАМП	53332	РАЗМЕРЫ									
		DN	A	B	C	D	E	F	L	резьб DIN 405 Rd x s	кг
	15-180 hl	16	78	77	60	34	210				1,31
	20-180 hl	20	78	77	60	34	210				1,31
	25-180 hl	26	81,5	77	60	50,5	210				1,31
	20-500 hl	20	83	85	75	34	235				2,19
	25-500 hl	26	86,6	85	75	50,5	235				2,19
	32-1000 hl	32	99,5	129	110	50,5	285				3,99

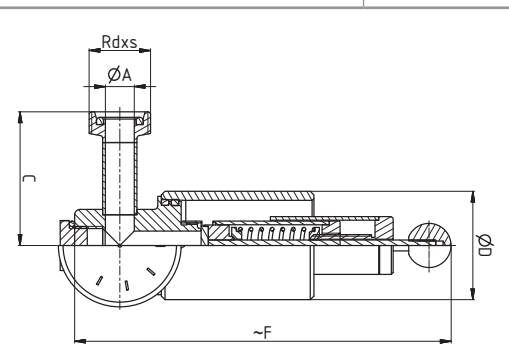
ШПУНТАППАРАТ ПРЯМОЙ РЕЗЬБА	53335	РАЗМЕРЫ									
		DN	A	B	C	D	E	F	L	резьб DIN 405 Rd x s	кг
	15-180 hl	16		74	60		210			34x1/8"	1,39
	20-180 hl	20		76	60		210			44x1/6"	1,39
	25-180 hl	26		79	60		210			52x1/6"	1,39
	20-500 hl	20		84	75		235			44x1/6"	2,17
	25-500 hl	26		87	75		235			52x1/6"	2,17
	32-1000 hl	32		113	110		285			58x1/6"	3,97

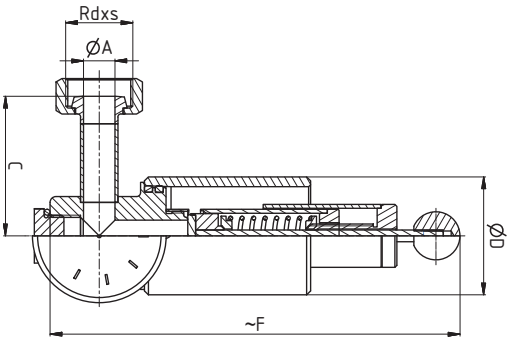
ШПУНТАППАРАТ ПРЯМОЙ ГАЙКА	53336	РАЗМЕРЫ									
		DN	A	B	C	D	E	F	L	резьб DIN 405 Rd x s	кг
	15-180 hl	16		71	60		210			34x1/8"	1,88
	20-180 hl	20		73	60		210			44x1/6"	1,88
	25-180 hl	26		75	60		210			52x1/6"	1,88
	20-500 hl	20		81	75		235			44x1/6"	2,22
	25-500 hl	26		83	75		235			52x1/6"	2,22
	32-1000 hl	32		106	110		285			58x1/6"	4,13

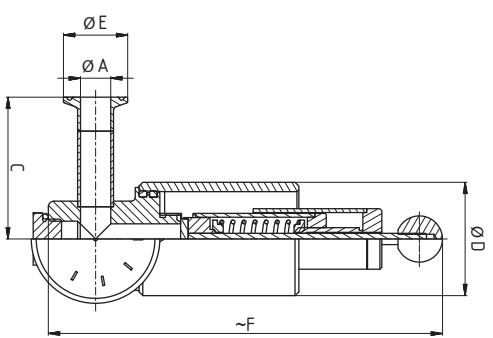
ШПУНТАППАРАТ ПРЯМОЙ КЛАМП	53337	РАЗМЕРЫ									
		DN	A	B	C	D	E	F	L	резьб DIN 405 Rd x s	кг
	15-180 hl	16		75	60	34	210				1,26
	20-180 hl	20		75	60	34	210				1,26
	25-180 hl	26		78,5	60	50,5	210				1,26
	20-500 hl	20		83	75	34	235				1,96
	25-500 hl	26		86,5	75	50,5	235				1,96
	32-1000 hl	32		102,5	110	50,5	285				3,86

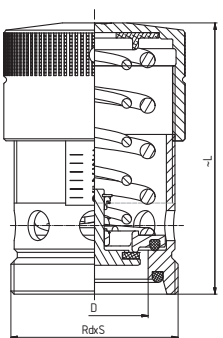
ВОЗДУШНЫЙ КЛАПАН ДВОЙНОГО ДЕЙСТВИЯ, РЕЗЬБА	53340	РАЗМЕРЫ									
		DN	A	B	C	D	D1	д вление	L	резьб DIN 405 Rd x s	кг
	40				38		0,1-2 б р	112		65x1/6"	1,6
	40				38		0,1-3 б р	133		65x1/6"	1,6
	50				50		0,1-2 б р	92		78x1/6"	1,4
	50				50		0,1-3 б р	126		78x1/6"	1,4
	50				50		0,1-6 б р	126		78x1/6"	1,4
	80				81		0,1-2 б р	180		110x1/4"	4,45

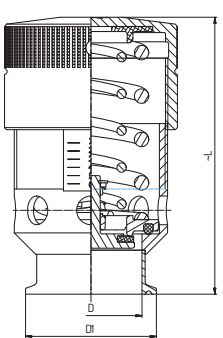
ВОЗДУШНЫЙ КЛАПАН ДВОЙНОГО ДЕЙСТВИЯ, КЛАМП	53343	РАЗМЕРЫ									
		DN	A	B	C	D	D1	д вление	L	резьб DIN 405 Rd x s	кг
	40				38	50,5	0,1-2 б р	112			1,4
	40				38	50,5	0,1-3 б р	146			1,4
	50				50	64	0,1-2 б р	92			1,3
	50				50	64	0,1-3 б р	133			1,3
	50				50	64	0,1-6 б р	133			1,3
	80				81	106	0,1-2 б р	180			4

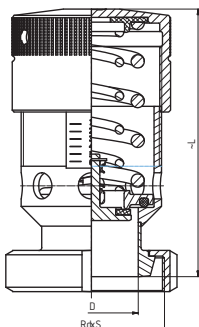
ВОЗДУШНЫЙ КЛАПАН ДВОЙНОГО ДЕЙСТВИЯ, ГАЙКА	53344	РАЗМЕРЫ									
		DN	A	B	C	D	D1	д вление	L	резьб DIN 405 Rd x s	кг
	40					38		0,1-2 б р	112	65x1/6"	
	40					38		0,1-3 б р	151	65x1/6"	
	50					50		0,1-2 б р	92	78x1/6"	
	50					50		0,1-3 б р	138	78x1/6"	
	50					50		0,1-6 б р	138	78x1/6"	
	80					81		0,1-2 б р	180	110x1/4"	

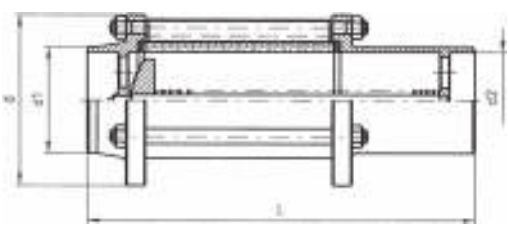
РАСХОДОМЕР СВАРКА-СВАРКА (SS) РЕЗЬБА-РЕЗЬБА (GG)	53350	РАЗМЕРЫ								
		DN	L	d	d1	d2	ρ сход, м³/ч		резьб DIN 405 Rd x s	кг
	25 GG	169	58	31	26	1,5-7			52x1/6"	0,78
	25 SS	153	58	31	26	1,0-4				0,6
	25 SS	153	58	31	26	0,5-2				0,6
	40 GG	188	79	43	38	7-11			65x1/6"	1,3
	40 SS	179	79	43	38	5-8,5				1
	40 SS	179	79	43	38	3-6				1
	50 GG	213	88	55	50	9-16			78x1/6"	1,85
	50 SS	196	88	55	50	6-12				1,4
	50 SS	196	88	55	50	4,5-8,5				1,4

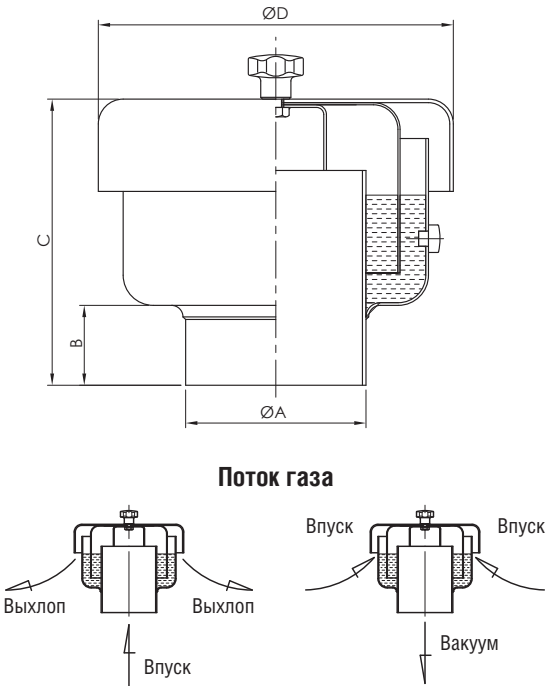
ДЫХАТЕЛЬНЫЙ КЛАПАН ДВОЙНОГО ДЕЙСТВИЯ	53362	РАЗМЕРЫ								
		DN	A	B	C	D	E	ρ сход м³/ч		кг
	60	60,3	45	165	170		50			
	70	76,14	45	165	170		50			
	80	88,9	45	170	220		100			
	100	101,6	45	170	220		100			



ДЫХАТЕЛЬНЫЙ КЛАПАН ДВОЙНОГО ДЕЙСТВИЯ 90°
53363
РАЗМЕРЫ

DN	A	I	H	D	E	ρ сход м³/ч	кг
60	60,3	170	270			50	
70	76,1	170	290			50	
80	88,9	220	320			100	
100	101,6	220	320			100	

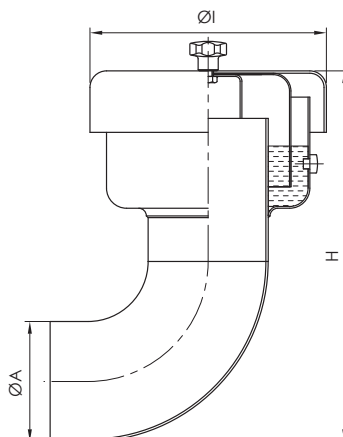
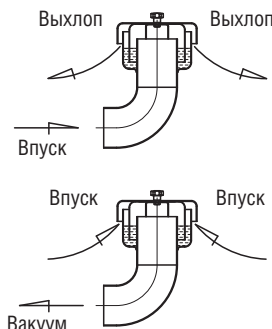
Поток газа

ВОЗДУШНЫЙ КЛАПАН ДВОЙНОГО ДЕЙСТВИЯ
53364
РАЗМЕРЫ

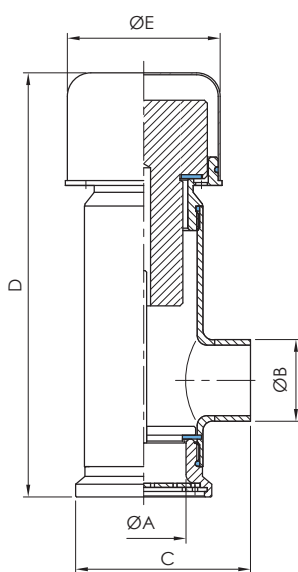
DN	A	B	C	D	E	ρ сход м³/ч	д вление ср - б ть в ния, б р	кг
40	54	42	100	213	80	20	-0,002 / +0,04	
50	54	50	100	213	80	30	-0,002 / +0,04	
80	83	85	135	290	110	50	-0,002 / +0,04	
100	104	104	145	320	125	80	-0,002 / +0,04	

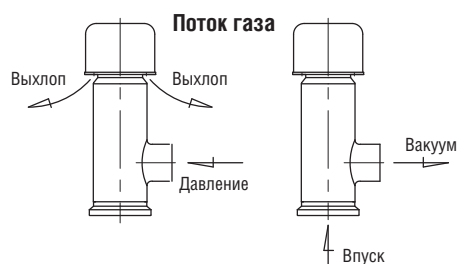

ХАРАКТЕРИСТИКИ

М тери л корпус и головки кл п н	AISI 304-316L
М тери л уплотнения	Silikon
Д вление открытия	0,04 б р
В куум открытия	-0,002 б р
Р боч я темпер тур	-20 °С ... +80 °С
Присоединение	DIN / SMS / Clamp

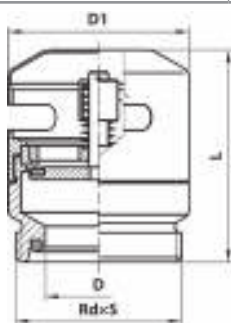

АНТИВАКУУМНЫЙ КЛАПАН
53380
РАЗМЕРЫ

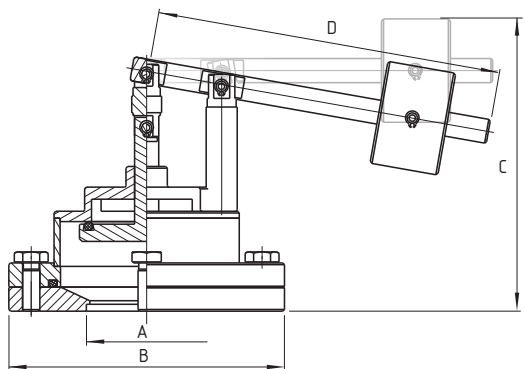
DN	для объем м³	ρ зниц °С	D	D1	L	резьб DIN 405 Rd x s	кг
50	10	80	50	80	95	78x1/6"	1,100
80	50	80	81	129	145	110x1/4"	3,350

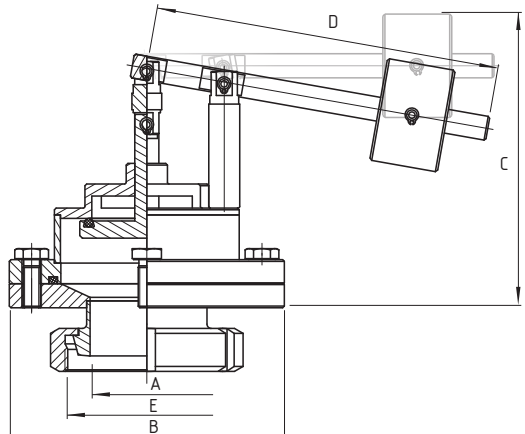

АНТИВАКУУМНЫЙ КЛАПАН ВЕСОВОГО ТИПА, ФЛАНЕЦ	53390		РАЗМЕРЫ									
	DN	A	B	C	D	резьб E	DIN 405	F	R	L	кг	
	50	52	140	137	170							
	65	70	160	140	200							
	80	85	190	147	220							
	100	104	210	149	255							
	125	129	235	158	265							
	150	154	270	163	300							

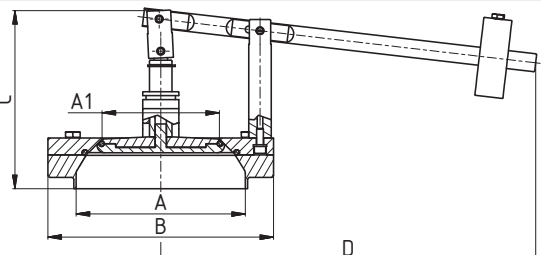
АНТИВАКУУМНЫЙ КЛАПАН ВЕСОВОГО ТИПА, ГАЙКА	53391		РАЗМЕРЫ									
	DN	A	B	C	D	резьб E	DIN 405	F	R	L	кг	
	50	52	140	137	170	78x1/6"						
	65	70	160	140	200	95x1/6"						
	80	85	190	147	220	110x1/4"						
	100	104	210	149	255	130x1/4"						
	125	129	235	158	265	160x1/4"						
	150	154	270	163	300	190x1/4"						

АНТИВАКУУМНЫЙ КЛАПАН ВЕСОВОГО ТИПА, СВАРКА	53395		РАЗМЕРЫ						
	тип NF	DN	A	A1	B	C	D		
		50							
		65							
		80							
		100	150	100	200	160	350		
		150							

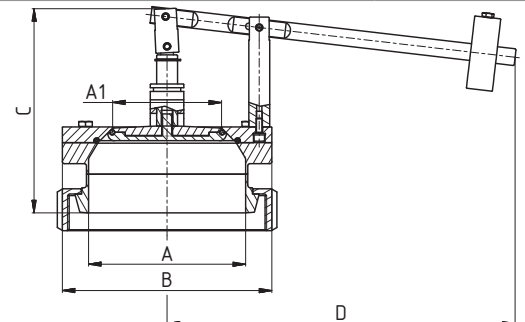
АНТИВАКУУМНЫЙ КЛАПАН ВЕСОВОГО ТИПА, ГАЙКА	53396		РАЗМЕРЫ						
	тип NF	DN	A	A1	B	C	D		
		50							
		65							
		80							
		100	150	100	200	197	350		
		150							

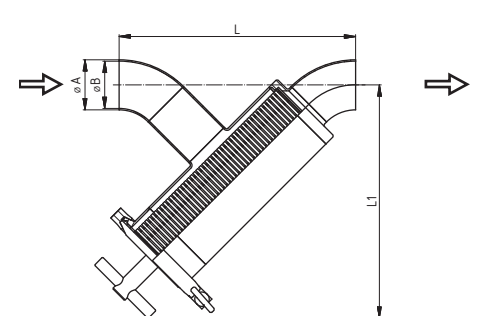
ФИЛЬТР ТРУБНЫЙ ЩЕЛЕВОЙ ПРЯМОЙ NF СВАРКА-СВАРКА	53431	РАЗМЕРЫ										
		DN	A	B	C	D	E	F	L	L1	резьб DIN 405 Rd x s	кг
	25	29	26						203,6	223,6		
	40	41	38						217,8	226,5		
	50	53	50						261,6	279,7		
	65	70	66						278,6	284,0		
	80	85	81						332,3	343,2		
	100	104	100						346,5	346,1		
Щелевой стержень – слот 1,0 и 0,5 мм ст нд рт Другие р змеры по з просу												

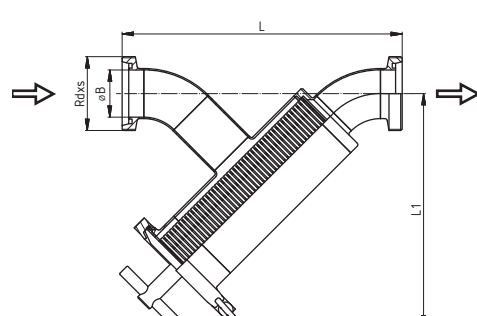
ФИЛЬТР ТРУБНЫЙ ЩЕЛЕВОЙ ПРЯМОЙ NF РЕЗЬБА-РЕЗЬБА	53432	РАЗМЕРЫ										
		DN	A	B	C	D	E	F	L	L1	резьб DIN 405 Rd x s	кг
	25		26						247,6	223,6	52x1/6"	
	40		38						261,8	226,5	65x1/6"	
	50		50						307,6	279,7	78x1/6"	
	65		66						328,6	284,0	95x1/6"	
	80		81						384,3	343,2	110x1/4"	
	100		100						406,5	346,1	130x1/4"	
Щелевой стержень – слот 1,0 и 0,5 мм ст нд рт Другие р змеры по з просу												

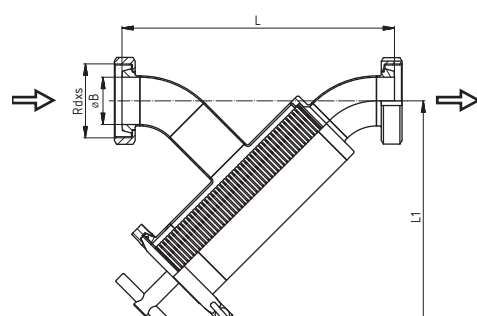
ФИЛЬТР ТРУБНЫЙ ЩЕЛЕВОЙ ПРЯМОЙ NF ГАЙКА-ГАЙКА	53433	РАЗМЕРЫ										
		DN	A	B	C	D	E	F	L	L1	резьб DIN 405 Rd x s	кг
	25		26						239,6	223,6	52x1/6"	
	40		38						253,8	226,5	65x1/6"	
	50		50						299,6	279,7	78x1/6"	
	65		66						320,6	284,0	95x1/6"	
	80		81						374,3	343,2	110x1/4"	
	100		100						396,5	346,1	130x1/4"	
Щелевой стержень – слот 1,0 и 0,5 мм ст нд рт Другие р змеры по з просу												

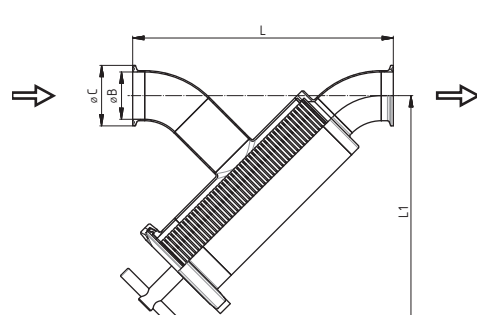
ФИЛЬТР ТРУБНЫЙ ЩЕЛЕВОЙ ПРЯМОЙ NF КЛАМП-КЛАМП	53435	РАЗМЕРЫ										
		DN	A	B	C	D	E	F	L	L1	резьб DIN 405 Rd x s	кг
	25		26	50,5					229,0	223,6		
	40		38	50,5					243,2	226,5		
	50		50	64					287,0	279,7		
	65		66	91					304,0	284,0		
	80		81	106					357,7	343,2		
	100		100	119					378,1	346,1		
Щелевой стержень – слот 1,0 и 0,5 мм ст нд рт Другие р змеры по з просу												

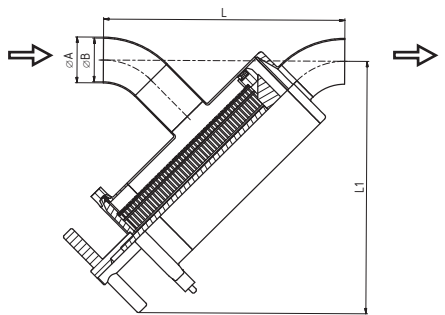
ФИЛЬТР ТРУБНЫЙ ЩЕЛЕВОЙ ПРЯМОЙ NF СВАРКА-СВАРКА	53441	РАЗМЕРЫ							резьб DIN 405 Rd x s	кг
	SMS	DN	A	B	C	L	L1			
	25	25	22,5				223,6			
	38	38,1	35,5				226,5			
	51	51	48,5	268,7	281,1		279,7			
	63	63,5	60,5				284			
	76	76,1	72,9				343,2			
	101	101,6	97,6				346,1			
Щелевой стержень – слот 0,5 и 1,0 мм Трубок с отверстиями 0,8-5,0 мм Другие размеры по запросу										

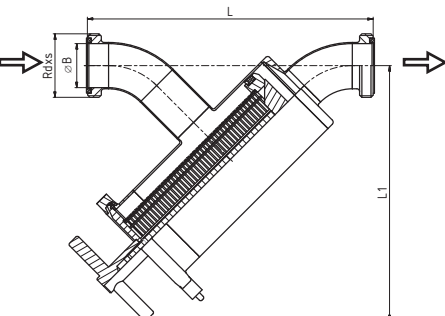
ФИЛЬТР ТРУБНЫЙ ЩЕЛЕВОЙ ПРЯМОЙ NF РЕЗЬБА-РЕЗЬБА	53442	РАЗМЕРЫ							резьб DIN 405 Rd x s	кг
	SMS	DN	A	B	C	L	L1			
	25		22,5						40x1/6"	
	38		35,5						60x1/6"	
	51		48,5			315	281,1		70x1/6"	
	63		60,5						85x1/6"	
	76		72,9						98x1/6"	
	101		97,6						125x1/4"	
Щелевой стержень – слот 0,5 и 1,0 мм Трубок с отверстиями 0,8-5,0 мм Другие размеры по запросу										

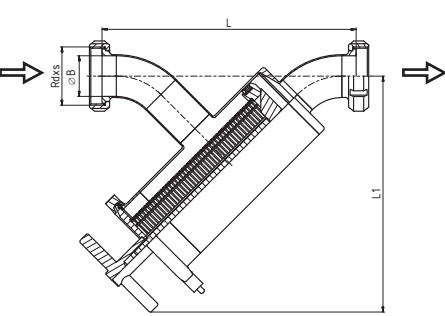
ФИЛЬТР ТРУБНЫЙ ЩЕЛЕВОЙ ПРЯМОЙ NF ГАЙКА-ГАЙКА	53443	РАЗМЕРЫ							резьб DIN 405 Rd x s	кг
	SMS	DN	A	B	C	L	L1			
	25		22,5						40x1/6"	
	38		35,5						60x1/6"	
	51		48,5			302,7	281,1		70x1/6"	
	63		60,5						85x1/6"	
	76		72,9						98x1/6"	
	101		97,6						125x1/4"	
Щелевой стержень – слот 0,5 и 1,0 мм Трубок с отверстиями 0,8-5,0 мм Другие размеры по запросу										

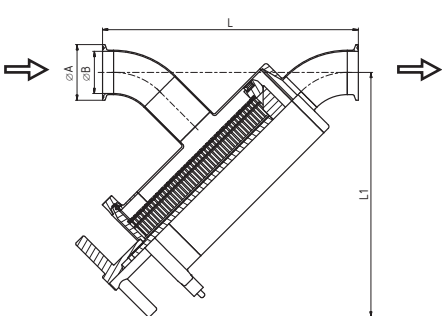
ФИЛЬТР ТРУБНЫЙ ЩЕЛЕВОЙ ПРЯМОЙ NF КЛАМП-КЛАМП	53445	РАЗМЕРЫ							резьб DIN 405 Rd x s	кг
	SMS	DN	A	B	C	L	L1			
	25	50,5	22,5							
	38	50,5	35,5							
	51	64	48,5			294,1	281,1			
	63	77,5	60,5							
	76	91	72,9							
	101	119	97,6							
Щелевой стержень – слот 0,5 и 1,0 мм Трубок с отверстиями 0,8-5,0 мм Другие размеры по запросу										

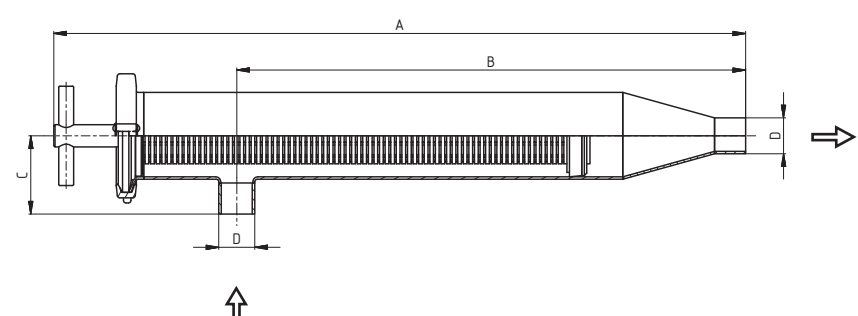
ФИЛЬТР ТРУБНЫЙ ЩЕЛОВОЙ УГЛОВОЙ NF СВАРКА-СВАРКА	53451	РАЗМЕРЫ					
		DN	A	B	C	D	E
	25	557,5	410	63	29		
	32	547	399,5	63	35		
	40	534,5	387	63	41		
	50	595,5	423	85	53		
	65	563,5	391	85	70		
	80	770	564	130	85		
	100	731	525	130	104		
Щелевой стержень – слот 1,0 и 0,5 мм ст нд рт							
Другие р змеры по з просу							

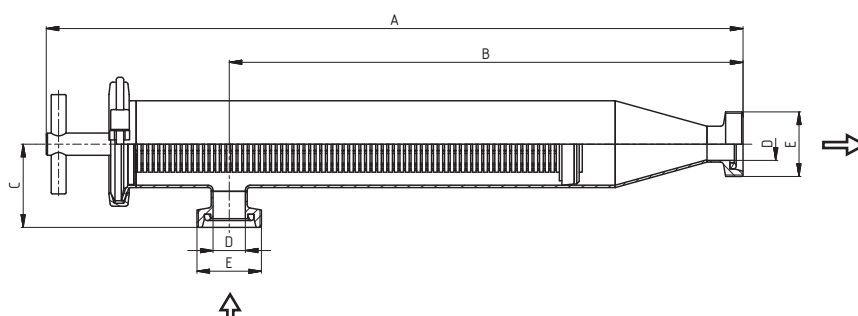
ФИЛЬТР ТРУБНЫЙ ЩЕЛОВОЙ УГЛОВОЙ NF РЕЗЬБА-РЕЗЬБА	53452	РАЗМЕРЫ					
		DN	A	B	C	D	резьб DIN 405 E
	25	561,5	414	67	26	52x1/6"	
	32	553,5	406,5	70	32	58x1/6"	
	40	542,5	395	71	38	65x1/6"	
	50	600,5	428	90	50	78x1/6"	
	65	573,5	401	95	66	95x1/6"	
	80	770	564	130	81	110x1/4"	
	100	740	534	139	100	130x1/4"	
Щелевой стержень – слот 1,0 и 0,5 мм ст нд рт							
Другие р змеры по з просу							

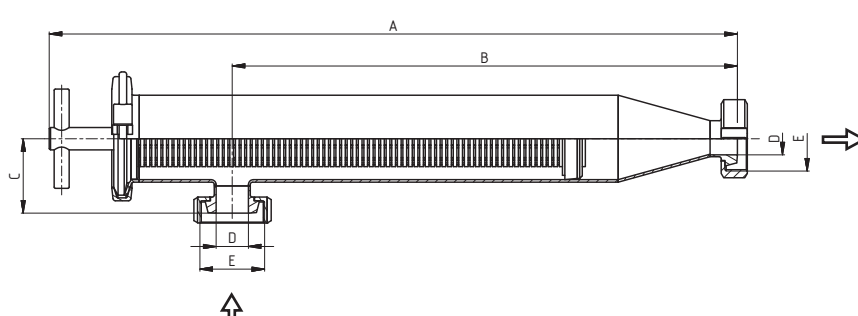
ФИЛЬТР ТРУБНЫЙ ЩЕЛОВОЙ УГЛОВОЙ NF ГАЙКА-ГАЙКА	53453	РАЗМЕРЫ					
		DN	A	B	C	D	резьб DIN 405 E
	25	554,5	407	60	26	52x1/6"	
	32	547	399,5	63	32	58x1/6"	
	40	535,5	388	64	38	65x1/6"	
	50	593,5	421	83	50	78x1/6"	
	65	565,5	393	87	66	95x1/6"	
	80	762	556	122	81	110x1/4"	
	100	730	524	129	100	130x1/4"	
Щелевой стержень – слот 1,0 и 0,5 мм ст нд рт							
Другие р змеры по з просу							

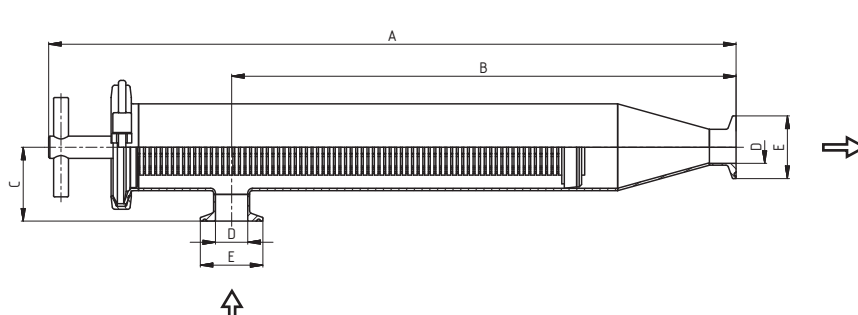
ФИЛЬТР ТРУБНЫЙ ЩЕЛОВОЙ УГЛОВОЙ NF КЛАМП-КЛАМП	53455	РАЗМЕРЫ					
		DN	A	B	C	D	E
	25	554	406,5	59,5	26	50,5	
	32	543,5	396	59,5	32	50,5	
	40	531	383,5	59,5	38	50,5	
	50	587	414,5	76,5	50	64	
	65	561,5	389	83	66	91	
	80	753	547	113	81	106	
	100	714	508	113	100	119	
Щелевой стержень – слот 1,0 и 0,5 мм ст нд рт							
Другие р змеры по з просу							

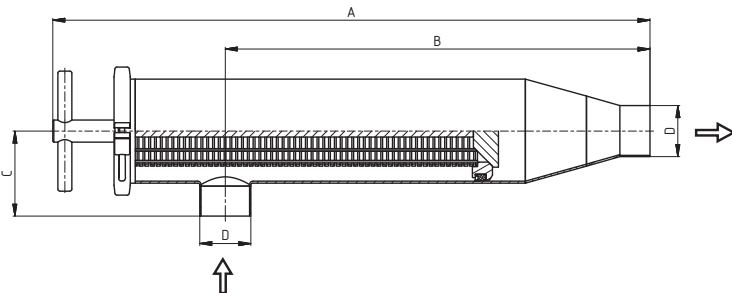
ФИЛЬТР ТРУБНЫЙ ЩЕЛЕВОЙ УГЛОВОЙ NF СВАРКА-СВАРКА	53461	РАЗМЕРЫ					
	SMS	DN	A	B	C	D	E
	25					25	
	38					38	
	51	596,9	424,5	85	51		
	63,5					63,5	
	76					76,1	
	101,6					101,6	
Щелевой стержень – слот 0,5 и 1,0 мм Трубок с отверстиями 0,8-5,0 мм Другие размеры по запросу							

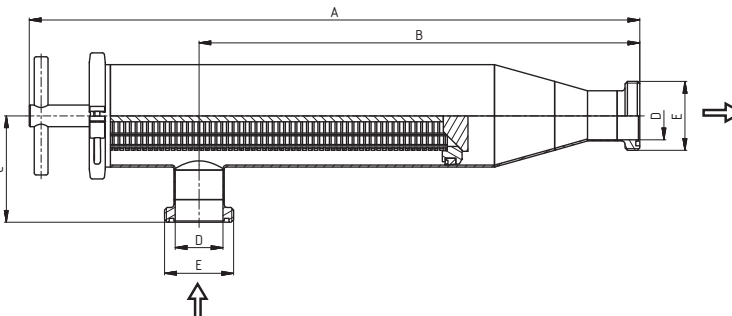
ФИЛЬТР ТРУБНЫЙ ЩЕЛЕВОЙ УГЛОВОЙ NF РЕЗЬБА-РЕЗЬБА	53462	РАЗМЕРЫ					
	SMS	DN	A	B	C	D	резьб DIN 405 E
	25					22,5	40x1/6"
	38					35,5	60x1/6"
	51	619,3	447,5	108	48,5	48,5	70x1/6"
	63,5					60,5	85x1/6"
	76					72,9	98x1/6"
	101,6					97,6	125x1/4"
Щелевой стержень – слот 0,5 и 1,0 мм Трубок с отверстиями 0,8-5,0 мм Другие размеры по запросу							

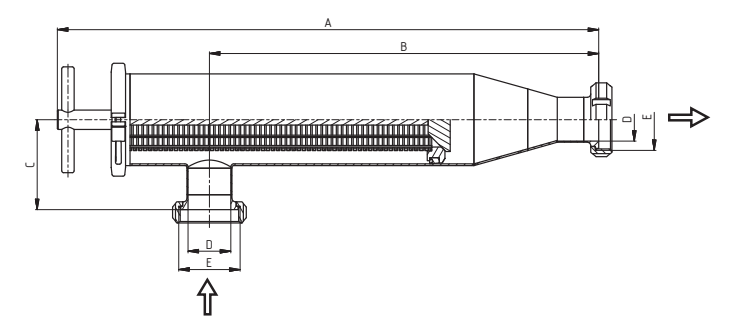
ФИЛЬТР ТРУБНЫЙ ЩЕЛЕВОЙ УГЛОВОЙ NF ГАЙКА-ГАЙКА	53463	РАЗМЕРЫ					
	SMS	DN	A	B	C	D	резьб DIN 405 E
	25					22,5	40x1/6"
	38					35,5	60x1/6"
	51	613,3	441,5	102	48,5	48,5	70x1/6"
	63,5					60,5	85x1/6"
	76					72,9	98x1/6"
	101,6					97,6	125x1/4"
Щелевой стержень – слот 0,5 и 1,0 мм Трубок с отверстиями 0,8-5,0 мм Другие размеры по запросу							

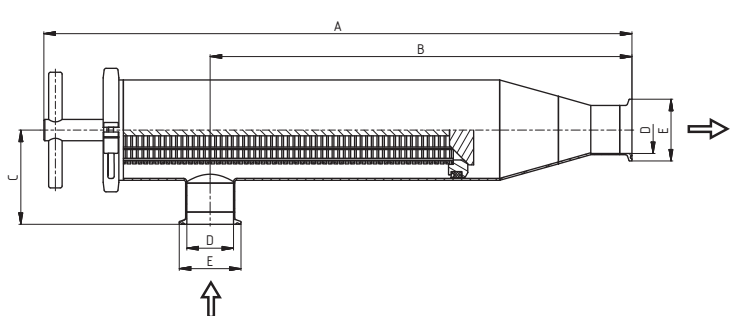
ФИЛЬТР ТРУБНЫЙ ЩЕЛЕВОЙ УГЛОВОЙ NF КЛАМП-КЛАМП	53465	РАЗМЕРЫ					
	SMS	DN	A	B	C	D	E
	25					22,5	50,5
	38					35,5	50,5
	51	596,9	424,5	97,7	48,5	48,5	64
	63,5					60,5	77,5
	76					72,9	91
	101,6					97,6	119
Щелевой стержень – слот 0,5 и 1,0 мм Трубок с отверстиями 0,8-5,0 мм Другие размеры по запросу							

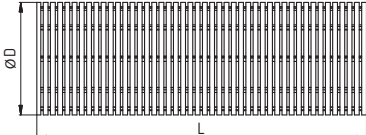
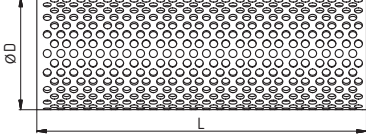
ФИЛЬТРУЮЩИЙ ЭЛЕМЕНТ ПРЯМОГО ФИЛЬТРА NF	5343V	РАЗМЕРЫ									
		DN	A	B	C	D	E	R	L	резьб DIN 405 Rd x s	кг
 	5343V-1	25				45			178		
		32				45			178		
		40				45			178		
		50				70			205		
		65				70			205		
		80				110			250		
		100				110			250		
Щелевой стержень – слот 1,0 и 0,5 мм ст нд рт Другие р змеры по з просу											

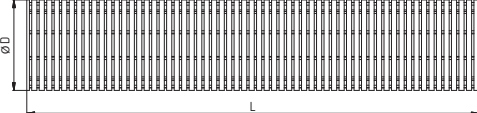
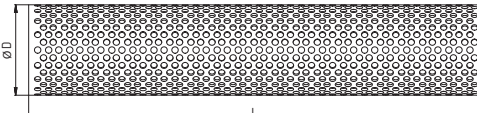
ФИЛЬТРУЮЩИЙ ЭЛЕМЕНТ УГЛОВОГО ФИЛЬТРА NF	5345V	РАЗМЕРЫ									
		DN	A	B	C	D	E	R	L	резьб DIN 405 Rd x s	кг
 	5345V-1	25				45			353		
		32				45			353		
		40				45			353		
		50				70			350		
		65				70			350		
		80				110			470		
		100				110			470		
Щелевой стержень – слот 1,0 и 0,5 мм ст нд рт Другие р змеры по з просу											

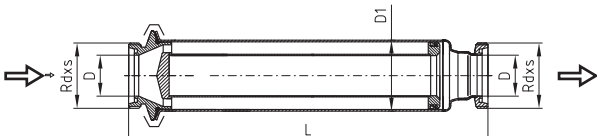
ФИЛЬТР ТРУБНЫЙ ПРЯМОЙ РЕЗЬБА-РЕЗЬБА	53470	РАЗМЕРЫ								
		DN	A	B	C	D	E	R	L	резьб DIN 405 Rd x s
	25				26	52	64	396	52x1/6"	
	32				32	70	91	402	58x1/6"	
	40				38	85	106	445	65x1/6"	
	50				50	85	106	437	78x1/6"	
	65				66	104	119	440	95x1/6"	
	80				81	129	155	645	110x1/4"	
	100				100	154	183	649	130x1/4"	
	125								160x1/4"	
	150								190x1/4"	

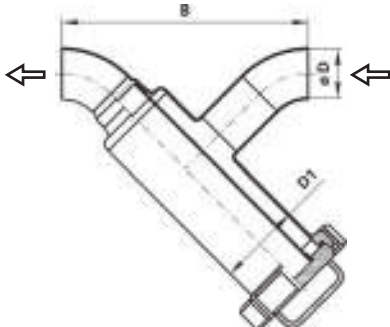
ФИЛЬТР ТРУБНЫЙ ПРЯМОЙ СВАРКА-СВАРКА	53480	РАЗМЕРЫ								
		DN	A	B	C	D	D1	R	L	резьб DIN 405 Rd x s
	25		187		26	52				
	32		210		32	70				
	40		249		38	85				
	50		272		50	85				
	65		259		66	104				
	80		328		81	129				
	100		376		100	154				

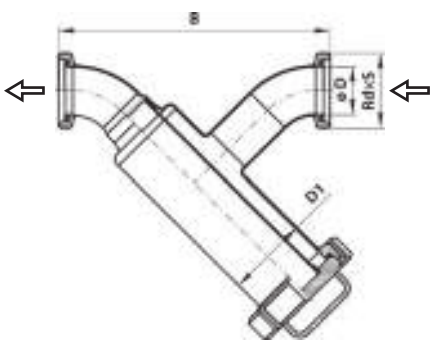
ФИЛЬТР ТРУБНЫЙ ПРЯМОЙ РЕЗЬБА-РЕЗЬБА	53490	РАЗМЕРЫ										
		DN	A	B	C	D	D1	F	R	L	резьб DIN 405 Rd x s	кг
	25		227		26	52					52x1/6"	
	32		250		32	70					58x1/6"	
	40		288		38	85					65x1/6"	
	50		312		50	85					78x1/6"	
	65		309		66	104					95x1/6"	
	80		384		81	129					110x1/4"	
	100		432		100	154					130x1/4"	

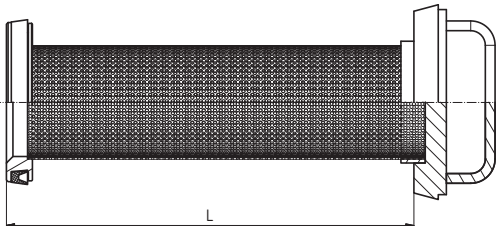
ФИЛЬТРУЮЩИЙ ЭЛЕМЕНТ ПРЯМОГО ФИЛЬТРА, ПЕРФОРАЦИЯ	5348V-P	РАЗМЕРЫ										
		DN	A	B	C	D	E	F	R	L	резьб DIN 405 Rd x s	кг
	25									195		
	32									202		
	40									200		
	50									220		
	65									257		
	80									260		
	100									320		

Стандартный размер отверстия 1,0 мм
Другие размеры (2, 3, 4, 5, 6 и 8 мм по запросу)

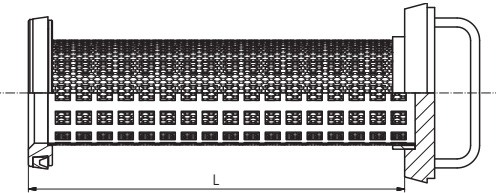
ФИЛЬТРУЮЩИЙ ЭЛЕМЕНТ ПРЯМОГО ФИЛЬТРА, СИТО	5348V-S	РАЗМЕРЫ										
		DN	A	B	C	D	E	F	R	L	резьб DIN 405 Rd x s	кг
	25									195		
	32									202		
	40									200		
	50									220		
	65									257		
	80									260		
	100									320		

Ситовые отверстия от 0,05 до 1,0 мм

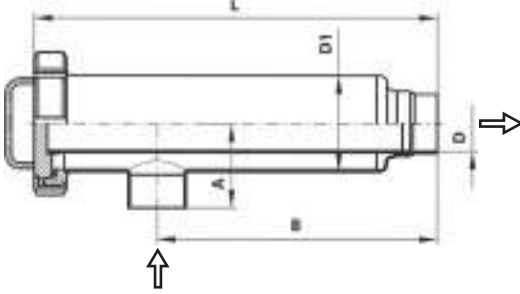
ФИЛЬТР ТРУБНЫЙ УГЛОВОЙ ПРЯМОУГОЛЬНЫЙ, СВАРКА-СВАРКА	53500	РАЗМЕРЫ										
		DN	A	B	D1	D	E	F	R	L	резьб DIN 405 Rd x s	кг
	25	55	222	52	26					318		1,7
	32	65	227	70	32					332		2,9
	40	75	245	85	38					356		4
	50	75	250	85	50					356		4,9
	65	85	265	104	66					383		5,8
	80	100	335	129	81					542		8,2
	100	115	345	154	100					571		11,4
	150	160	500	219	150					792		

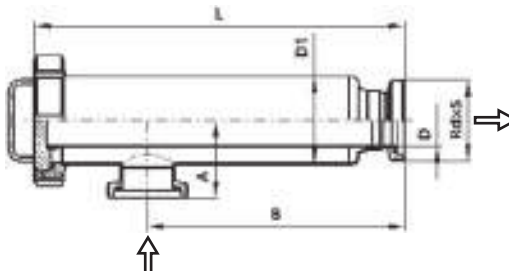
ФИЛЬТР ТРУБНЫЙ УГЛОВОЙ ПРЯМОУГОЛЬНЫЙ, РЕЗЬБА-РЕЗЬБА	53510	РАЗМЕРЫ										
		DN	A	B	D	D1	E	F	R	L	резьб DIN 405 Rd x s	кг
	25	55	230	26	52					318	52x1/6"	1,90
	32	65	235	32	70					332	58x1/6"	3,10
	40	75	245	38	85					356	65x1/6"	4,20
	50	75	250	50	85					356	78x1/6"	4,20
	65	85	275	66	104					383	95x1/6"	6,20
	80	100	345	81	129					542	110x1/6"	8,70
	100	115	355	100	154					571	130x1/6"	12,70
	125											
	150											

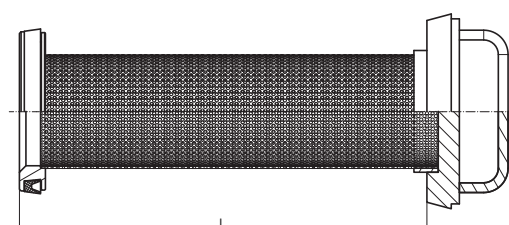
ФИЛЬТРУЮЩИЙ ЭЛЕМЕНТ УГЛОВОГО ФИЛЬТРА, ПЕРФОРАЦИЯ	5350V-P	РАЗМЕРЫ										
		DN	A	B	C	D	E	F	R	L	резьб DIN 405 Rd x s	кг
	25									250		
	32									257		
	40									282		
	50									290		
	65									317		
	80									460		
	100									470		

Стандартный размер отверстия 1,0 мм
 Другие размеры (2, 3, 4, 5, 6 и 8 мм по запросу)

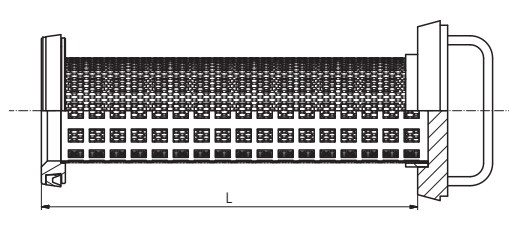
ФИЛЬТРУЮЩИЙ ЭЛЕМЕНТ УГЛОВОГО ФИЛЬТРА, СИТО	5350V-S	РАЗМЕРЫ										
		DN	A	B	C	D	E	F	R	L	резьб DIN 405 Rd x s	кг
	25									250		
	32									257		
	40									282		
	50									290		
	65									317		
	80									460		
	100									470		

Ситовые отверстия от 0,05 до 1,0 мм

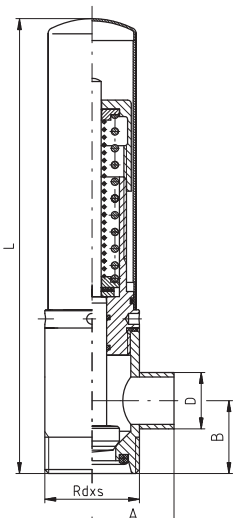
ПРЕДОХРАНИТЕЛЬНЫЙ КЛАПАН, РЕЗЬБА-СВАРКА	53600	РАЗМЕРЫ										
		DN	A	B	C	D	E	F	R	L	резьб DIN 405 Rd x s	кг
	25	45	40		31					250	52x1/6"	1,80
	32	50	50		37					255	58x1/6"	1,90
	40	65	55		43					325	65x1/6"	4,10
	50	65	60		55					325	78x1/6"	4,20
	65	70	75		72					330	95x1/6"	4,50

Давление: DN 25-32 0,3-8,0 бар
 DN 40-65 0,3-6,0 бар

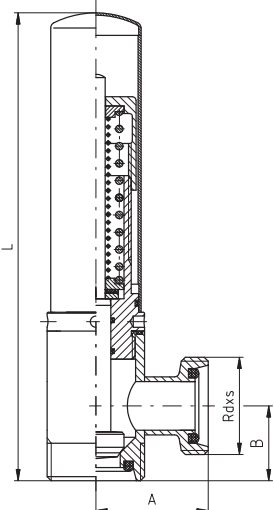
ПРЕДОХРАНИТЕЛЬНЫЙ КЛАПАН, РЕЗЬБА-РЕЗЬБА	53620		РАЗМЕРЫ									
	DN	A	B	C	D	E	F	R	L	резьб Rd x s	DIN 405	кг
	25	60	40						250	52x1/6"		1,90
	32	60	50						255	58x1/6"		2,00
	40	70	55						325	65x1/6"		4,25
	50	70	60						325	78x1/6"		4,30
	65	80	75						330	95x1/6"		4,70
<p>Д вление: DN 25-32 0,3-8,0 б р DN 40-65 0,3-4,0 б р</p>												

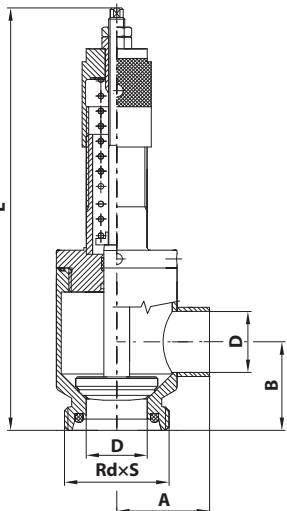
ПРЕДОХРАНИТЕЛЬНЫЙ КЛАПАН, РЕЗЬБА-СВАРКА	53700		РАЗМЕРЫ									
	DN	A	B	C	D	E	F	R	L	резьб Rd x s	DIN 405	кг
	25	44	40		26				245	52x1/6"		1,90
	32	53,5	50		32				250	58x1/6"		2,00
	40	63	55		38				285	65x1/6"		4,25
	50	66	60		50				295	78x1/6"		4,30
	65	125	85		66				340	95x1/6"		4,70
	80	140	95		81				365	110x1/4"		
<p>С мех ническим воздуховыпуском Д вление: DN 25-32 0,3-8,0 б р DN 40-65 0,3-4,0 б р</p>												

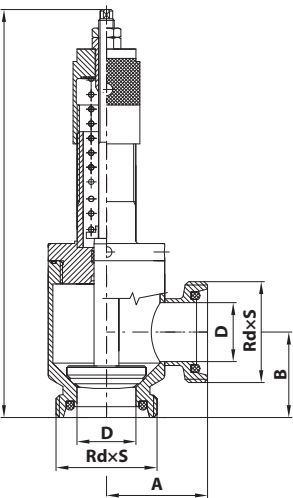
ПРЕДОХРАНИТЕЛЬНЫЙ КЛАПАН, РЕЗЬБА-РЕЗЬБА	53710		РАЗМЕРЫ									
	DN	A	B	C	D	E	F	R	L	резьб Rd x s	DIN 405	кг
	25	60	40		26				245	52x1/6"		1,90
	32	65	50		32				250	58x1/6"		2,00
	40	65	55		38				285	65x1/6"		4,25
	50	80	60		50				295	78x1/6"		4,30
	65	85	85		66				340	95x1/6"		4,70
	80	95	95		81				365	110x1/4"		
<p>С мех ническим воздуховыпуском Д вление: DN 25-32 0,3-8,0 б р DN 40-65 0,3-4,0 б р</p>												

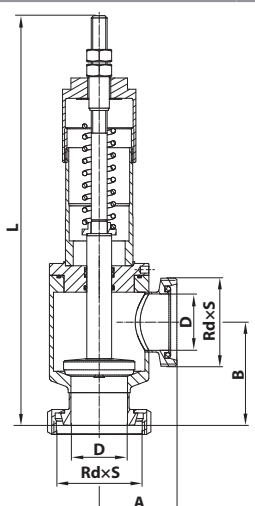
ПРЕДОХРАНИТЕЛЬНЫЙ КЛАПАН, ГАЙКА-РЕЗЬБА	53720	РАЗМЕРЫ										
		DN	A	B	C	D	E	F	R	L	резьб DIN 405 Rd x s	кг
	25	60	50		26					245	52x1/6"	1,90
	32	65	65		32					250	58x1/6"	2,00
	40	65	70		38					285	65x1/6"	4,25
	50	80	70		50					295	78x1/6"	4,30
	65	85	85		66					340	95x1/6"	4,70
	80	95	100		81					365	110x1/4"	
<p>С механическим воздуховыпуском</p> <p>Двление: DN 25-32 0,3-8,0 бар DN 40-65 0,3-4,0 бар</p>												

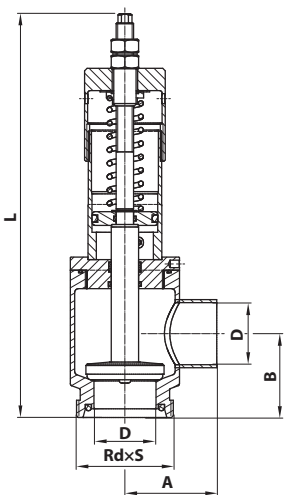
ПРЕДОХРАНИТЕЛЬНЫЙ КЛАПАН, РЕЗЬБА-СВАРКА	53750	РАЗМЕРЫ										
		DN	A	B	C	D	E	F	R	L	резьб DIN 405 Rd x s	кг
	25	44	40		26					245	52x1/6"	1,90
	32	53,5	50		32					250	58x1/6"	2,00
	40	63	55		38					285	65x1/6"	4,25
	50	66	60		50					295	78x1/6"	4,30
	65	125	85		66					340	95x1/6"	4,70
	80	140	95		81					365	110x1/4"	
<p>С пневматическим воздуховыпуском</p> <p>Двление: DN 25-32 0,3-8,0 бар DN 40-65 0,3-4,0 бар</p>												

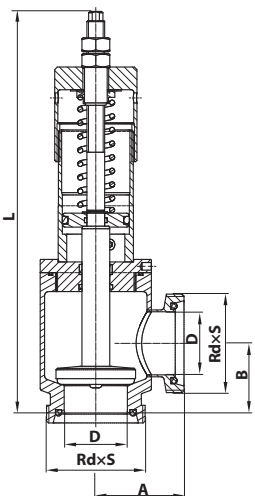
ПРЕДОХРАНИТЕЛЬНЫЙ КЛАПАН, РЕЗЬБА-РЕЗЬБА	53760	РАЗМЕРЫ										
		DN	A	B	C	D	E	F	R	L	резьб DIN 405 Rd x s	кг
	25	60	40		26					245	52x1/6"	2,10
	32	65	50		32					250	58x1/6"	2,20
	40	65	55		38					285	65x1/6"	4,45
	50	80	60		50					295	78x1/6"	4,50
	65	85	85		66					340	95x1/6"	4,90
	80	95	95		81					365	110x1/4"	
<p>С пневматическим воздуховыпуском</p> <p>Двление: DN 25-32 0,3-8,0 бар DN 40-65 0,3-4,0 бар</p>												

**ПРЕДОХРАНИТЕЛЬНЫЙ
КЛАПАН, ГАЙКА-РЕЗЬБА**

53770

РАЗМЕРЫ

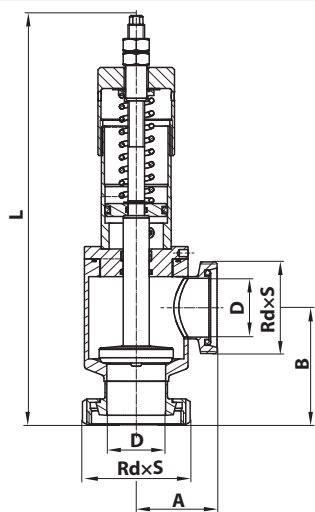

DN	A	B	D	L	резьб DIN 405 Rd x s	кг
25	60	50	26	245	52x1/6"	1,90
32	65	65	32	250	58x1/6"	2,00
40	65	70	38	285	65x1/6"	4,25
50	80	70	50	295	78x1/6"	4,30
65	85	85	66	340	95x1/6"	4,70
80	95	100	81	365	110x1/4"	

С пневматическим воздуховыпуском

Давление: DN 25-32 0,3-8,0 бар
DN 40-65 0,3-4,0 бар

**РЫЧАГ ДЛЯ
ПРИНУДИТЕЛЬНОГО
ОТКРЫТИЯ КЛАПАНА**

53795



Для продуктов 53700, 53710, 53720

Материал 1.4301

**КОМПЛЕКТ ВЕРХУШЕЧНОЙ АРМАТУРЫ
С АНТИВАКУУМНЫМ КЛАПАНОМ ВЕСОВОГО ТИПА**

54500

КОМПЛЕКТУЮЩИЕ

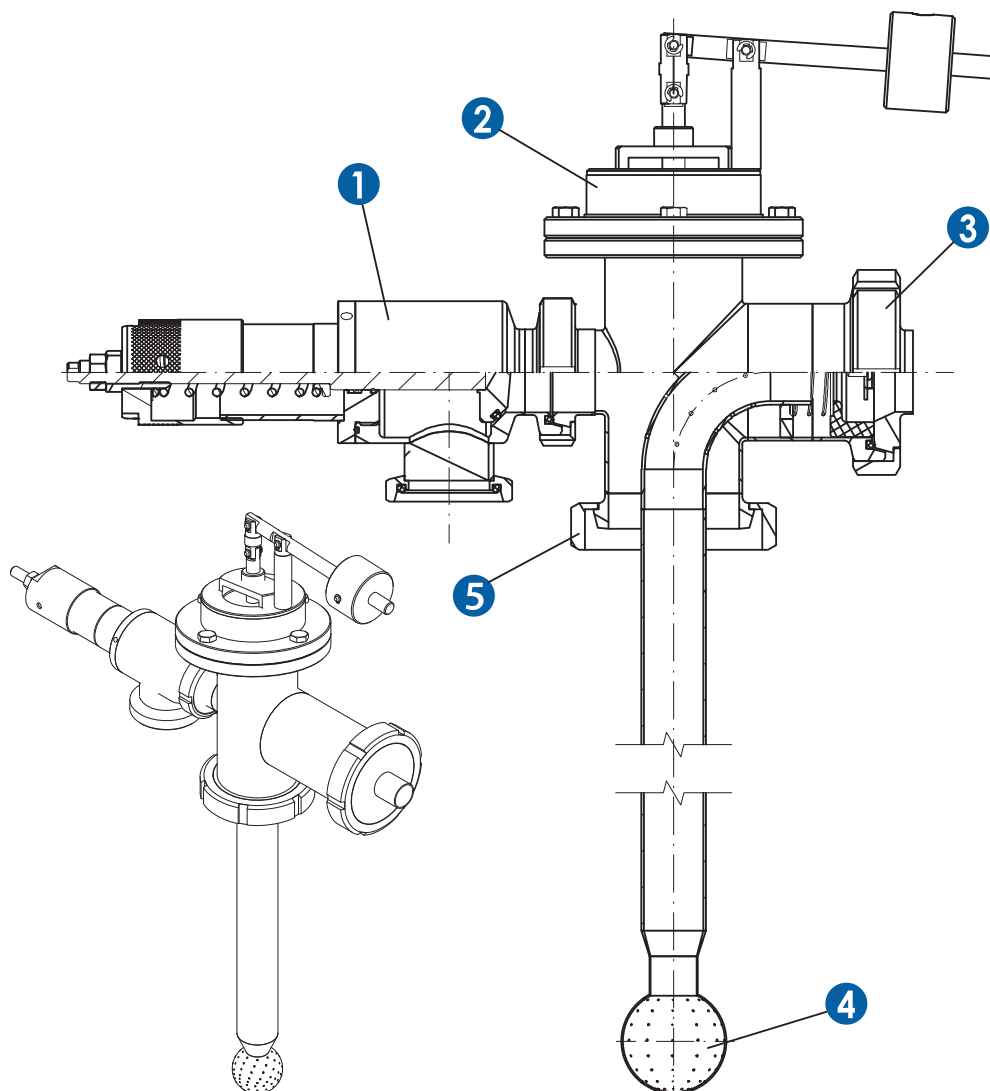

- 1 Предохранительный клапан
- 2 Вакуумный кран
- 3 Соединение для сварки
- 4 Мощная головка
- 5 Соединительная гайка

ПРЕДОХРАНИТЕЛЬНЫЙ КЛАПАН
59841
РАЗМЕРЫ

DN	A	Н стройк , б р
3/8" 1/2"	56	0,5 – 2,0
	56	1,8 – 4,0
	56	3,8 – 8,5
	56	8,0 – 16
1"	56	0,1 – 0,4
	56	0,5 – 3,5
	56	3,6 – 11

ХАРАКТЕРИСТИКИ

М тери л корпус и головки	AISI 316
М тери л пружины	AISI 302 / EN 1.4310
М тери л уплотнения	EPDM (VITON по з просу)
Регулируемое д вление открытия	0,5 – 16 б р
З оръ з крытия	≤ 20 %
Р бо ч я темпер тур	-20°C / +150°C
Резьб н ружн я	ISO 228-1

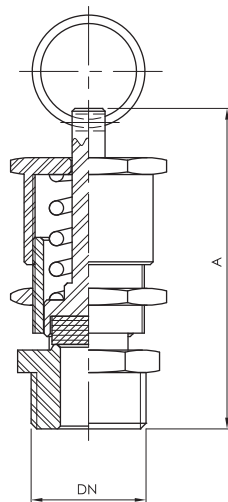
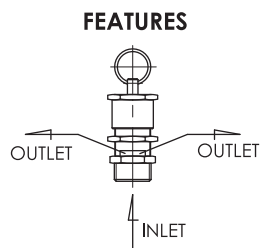



5

Аксессуары

Шланги
Хомуты

683-7

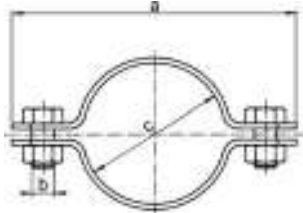
ХОМУТ ТРУБНЫЙ	70210		РАЗМЕРЫ							
	DN	A	B	C						кг
	10	53	M6	13						
	15	60	M6	20						
	20	64	M6	25						
	25	80	M6	30						
	32	76	M6	36						
	40	83	M8	42						
	50	100	M8	55						
	65	119	M8	72						
	80	138	M8	86						
	100	161	M8	105						
	125	198	M8	130						
	150	215	M8	156						

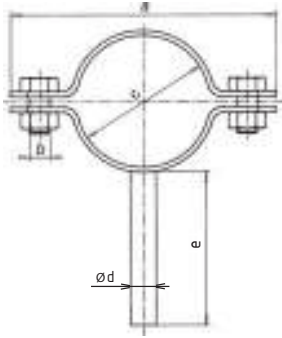
ХОМУТ ТРУБНЫЙ С ДЕРЖАТЕЛЕМ	70220		РАЗМЕРЫ							
	DN	A	B	C	D	E				кг
	10	53	M6	13	8	60				
	15	60	M6	20	8	60				
	20	64	M6	25	8	60				
	25	80	M6	30	10	60				
	32	76	M6	36	10	60				
	40	83	M8	42	10	60				
	50	100	M8	55	12	60				
	65	119	M8	72	12	60				
	80	138	M8	86	12	60				
	100	161	M8	105	12	60				
	125	198	M8	130	18	60				
	150	215	M8	156	18	60				

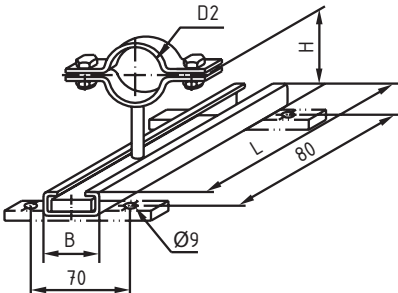
ОПОРА СКОЛЬЗЯЩАЯ	70261		РАЗМЕРЫ							
	DN	D2	H	B	L	изменение длины				кг
	10	13	71	30	120	50				0,24
	15	20	74,5	30	120	50				0,27
	20	25	77	30	120	50				0,28
	25	30	79,5	30	120	50				0,30
	32	36	82,5	30	120	50				0,31
	40	42	85,5	30	120	50				0,32
	50	55	92	30	120	50				0,33
	65	72	100,5	30	120	50				0,36
	80	86	107,5	30	120	50				0,47
	100	105	117	30	120	50				0,52
	125	130	129,5	30	120	50				
	150	156	142,5	30	120	50				

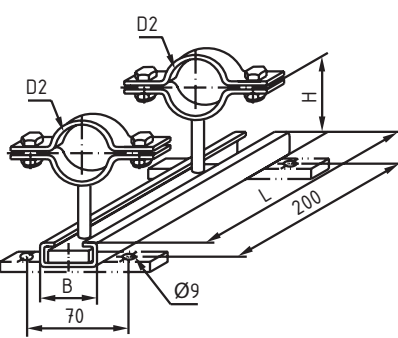
ОПОРА СКОЛЬЗЯЩАЯ	70262		РАЗМЕРЫ							
	DN	D2	H	B	L	изменение длины				кг
	10	13	71	30	300	100				0,28
	15	20	74,5	30	300	100				0,34
	20	25	77	30	300	100				0,36
	25	30	79,5	30	300	100				0,40
	32	36	82,5	30	300	100				0,42
	40	42	85,5	30	300	100				0,44
	50	55	92	30	300	100				0,46
	65	72	100,5	30	300	100				0,52
	80	86	107,5	30	300	100				0,74
	100	105	117	30	300	100				0,84
	125	130	129,5	30	300	100				
	150	156	142,5	30	300	100				

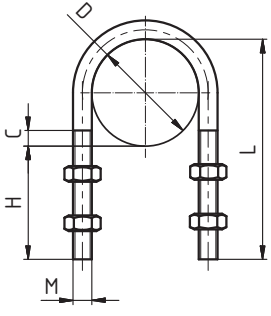
ХОМУТ U-ОБРАЗНЫЙ КОРОТКИЙ	70300		РАЗМЕРЫ									
	DN	A	B	C	D	H	L	M				кг
	10				12	35	47	M6				
	15				18	35	53	M6				
	20				22	35	57	M6				
	25			10	28	35	63	M6				
	32			10	34	35	69	M6				
	40			15	40	35	75	M8				
	50			15	52	35	87	M8				
	65			15	70	35	105	M8				
	80			15	85	35	120	M10				
	100			15	104	35	139	M10				
	125			15	129	35	164	M10				
	150			15	154	35	189	M10				
	200			15	204	35	239	M10				

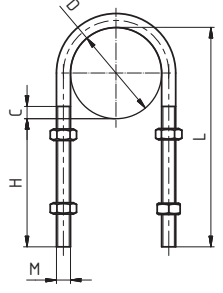
ХОМУТ U-ОБРАЗНЫЙ СРЕДНИЙ	70310		РАЗМЕРЫ									
	DN	A	B	C	D	H	L	M				кг
	10				12	65	77	M6				
	15				18	65	83	M6				
	20				22	65	87	M6				
	25			10	28	65	93	M6				
	32			10	34	65	99	M6				
	40			15	40	65	105	M8				
	50			15	52	65	117	M8				
	65			15	70	65	135	M8				
	80			15	85	65	150	M10				
	100			15	104	65	169	M10				
	125			15	129	65	194	M10				
	150			15	154	65	219	M10				
	200			15	204	65	269	M10				

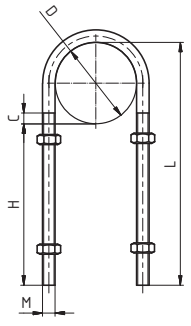
ХОМУТ U-ОБРАЗНЫЙ ДЛИННЫЙ	70320		РАЗМЕРЫ									
	DN	A	B	C	D	H	L	M				кг
	10				12	95	107	M6				
	15				18	95	113	M6				
	20				22	95	117	M6				
	25			10	28	95	123	M6				
	32			10	34	95	129	M6				
	40			15	40	95	135	M8				
	50			15	52	95	147	M8				
	65			15	70	95	165	M8				
	80			15	85	95	180	M10				
	100			15	104	95	199	M10				
	125			15	129	95	224	M10				
	150			15	154	95	249	M10				
	200			15	204	95	299	M10				

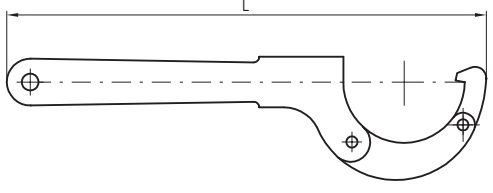
КЛЮЧ ГАЕЧНЫЙ	70500		РАЗМЕРЫ									
	DN	A	B	C	D	E	F	R	L		кг	
	25-65									270		
	65-150									450		

ПАСТА ДЛЯ ТРАВЛЕНИЯ НЕРЖАВЕЮЩЕЙ СТАЛИ	75010	ВЕС							
									кг
									2
									4
									6
									8
									10
									14
									15
									16
									18
									20

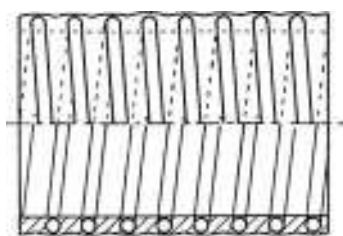
СПЕЦИАЛЬНЫЙ ГИБКИЙ ШЛАНГ ДЛЯ ВИНА	76060	ПАРАМЕТРЫ						
		DN	Ø D мм	д вление б р	р зрение б р	вес кг/м	длин м	
	25	32,0	8	0,9	0,40	50	Р боч я темпер тур : от -5 °С до +60 °С Жесткое рмиров ние PVC Внутри гл дкий	
	30	38,0	8	0,9	0,50	50		
	32	40,0	8	0,9	0,52	50		
	35	43,2	8	0,9	0,60	50		
	38	47,0	8	0,9	0,73	50		
	40	49,0	8	0,9	0,75	50		
	45	54,0	8	0,9	0,90	50		
	50	59,6	8	0,9	1,10	50		
	60	70,0	7	0,9	1,45	50		
	63	73,6	7	0,9	1,68	50		
	70	82,4	6	0,9	1,80	50		
	75	88,6	6	0,9	1,90	50		
	80	94,0	5	0,9	2,20	50		
90	105,0	5	0,9	2,56	30			
100	116,0	4	0,9	3,30	30			

Гибкий шл нг
Применение: тр нспортировк н питков и продуктов

ВПУСКНОЙ И НАПОРНЫЙ ШЛАНГ ДЛЯ ПИЩЕВЫХ ЖИДКОСТЕЙ	76070	ПАРАМЕТРЫ						
		DN	Ø D мм	д вление б р	р зрение б р	вес кг/м	длин м	
	10	16	7	0,85	0,16	60	Р боч я темпер тур : от -5 °С до +60 °С Безоп сность: 3:1 Армиров ние: спир ль из ст льной проволоки – г р нтирует высокую гибкость М тери л: пл стифициро- в нный PVC – прозр чный, пищевой, устойчивый к озону	
	12	18	7	0,85	0,18	60		
	14	20	6	0,85	0,20	60		
	16	22	6	0,85	0,24	60		
	18	24	6	0,85	0,30	60		
	20	27	5	0,85	0,35	60		
	22	29	5	0,85	0,38	60		
	25	33	5	0,85	0,51	60		
	32	40	4	0,85	0,65	60		
	35	44	4	0,85	0,75	60		
	40	50	3	0,80	0,87	30		
	45	55	3	0,80	1,13	30		
	50	60	3	0,80	1,20	30		
60	72	3	0,80	1,80	30			
63	75	3	0,80	1,85	30			

Гибкий шл нг
Применение: тр нспортировк пищевых продуктов без жир – питьев я вод , сусл , соки, вино, лкольные н питки до 28%, уксус, кетчуп и т.п.

ВПУСКНОЙ И НАПОРНЫЙ ШЛАНГ ДЛЯ ПИЩЕВЫХ ЖИДКОСТЕЙ	76080	ПАРАМЕТРЫ						
		DN	Ø D мм	д вление б р	р зрение б р	вес кг/м	длин м	
	20		8	0,7	0,30	50	Р боч я темпер тур : от -5 °С до +60 °С Безоп сность: 3:1 Армиров ние: спир ль из твердого PVC – бел я М тери л: пл стифициро- в нный PVC – прозр чный (желтый прозр чный), пищевой	
	25		8	0,7	0,40	50		
	32		7	0,7	0,48	50		
	40		6	0,7	0,60	50		
	45		6	0,7	0,70	50		
	51		5	0,7	0,85	50		
	60		5	0,7	1,00	50		
	63		5	0,7	1,10	50		
	70		5	0,7	1,25	50		
	76		5	0,7	1,40	50		
	80		4	0,7	1,60	30		
	90		4	0,7	1,85	30		
	102		4	0,7	2,20	30		

Гибкий шл нг
Применение: тр нспортировк пищевых продуктов без жир при низком д влении – питьев я вод , сусл , соки, вино, лкольные н питки до 28%, уксус, кетчуп и т.п.

НАПОРНЫЙ И ПОДАЮЩИЙ ШЛАНГ ДЛЯ МОЛОКА И ПРОДУКТОВ	76140		ПАРАМЕТРЫ				
	DN	Ø D мм	д вление б р	р зрежение б р	вес кг/м	длин м	
 Гибкий шланг Применение: транспортировка напитков, продуктов и алкоголя до 40%. Специальный тип для молоковозов. Высокогибкое исполнение Стерилизация: дезинфицирующим раствором при температуре +100 °С в течении 30 мин	40	52	6	0,60	1,25	40/60	Рабочая температура: от -35 °С до +85 °С Безопасность: 3:1 Армирование: текстильная оплетка, спираль из стальной проволоки Внутренняя камера: резин NR – белая, пищевая, безопасная Внешнее покрытие: резин NR – синяя, устойчивая к озону и износу
	50	63	6	0,60	2,19	40/60	
	63	77	6	0,50	2,19	40/60	

ПИЩЕВОЙ НАПОРНЫЙ ШЛАНГ	76180		ПАРАМЕТРЫ				
	DN	Ø D мм	д вление б р	р зрежение б р	вес кг/м	длин м	
 Гибкий шланг Применение: транспортировка пищевых продуктов, пива, вина, молочных продуктов, кремов, дистиллятов до 40% и т.д. Шланг предназначен для продуктов, содержащих растительные и животные жиры Стерилизация: раствором при давлении 2,5 бар и температуре +130 °С в течении 30 минут или дезинфицирующим раствором при температуре +90 °С	13	22	10		0,26	60	Рабочая температура: от -35 °С до +85 °С Безопасность: 3:1 Армирование: текстильная оплетка Внутренняя камера: резин NR – белая, пищевая, устойчивая Внешнее покрытие: резин SBR/EPDM – черная, устойчивая к озону и износу
	16	24	10		0,35	60	
	19	28	10		0,44	60	
	25	35	10		0,64	60	
	32	44	10		1,01	60	
	40	54	10		1,43	60	
	51	65	10		1,78	60	
	63	81	10		2,86	60	
	76	92	10		2,65	60	
	80	96	10		2,98	60	
102	123	10		5,15	60		

НАПОРНЫЙ И ПОДАЮЩИЙ ШЛАНГ ДЛЯ ПРОДУКТОВ	76210		ПАРАМЕТРЫ				
	DN	Ø D мм	д вление б р	р зрежение б р	вес кг/м	длин м	
 Гибкий шланг Применение: шланг с высоким качеством, транспортировка напитков, продуктов и алкоголя до 98%. Специальный тип для пивоваренных и ликероводочных напитков. Не предназначен для масел и жиров Стерилизация: раствором при давлении 3 бар и максимальной температурой +160 °С в течении 30 минут или дезинфицирующим раствором при температуре +90 °С	25	38	10	0,95	0,91	40/60	Рабочая температура: от -35 °С до +120 °С Безопасность: 3:1 Армирование: текстильная оплетка, спираль из стальной проволоки Внутренняя камера: резин IIR (бутил) – белая, пищевая, абсолютно нейтральное воздействие на вкус и запах Внешнее покрытие: резин EPDM – черная, пищевая, устойчивая к озону и износу
	32	46	10	0,95	1,19	40/60	
	38	52	10	0,95	1,45	40/60	
	51	65	10	0,90	1,92	40/60	
	63	80	10	0,90	2,83	40/60	
	76	93	10	0,90	3,45	40/60	
	80	98	10	0,85	3,90	40/60	
100	120	10	0,85	4,90	40/60		

НАПОРНЫЙ И ПОДАЮЩИЙ ШЛАНГ ДЛЯ ЖИРОВ И МАСЕЛ	76220		ПАРАМЕТРЫ				
	DN	Ø D мм	д вление б р	р зрежение б р	вес кг/м	длин м	
 Гибкий шланг Применение: транспортировка пищевых продуктов, содержащих растительные и животные жиры. Также предназначен для отжима пива, вина, молочных продуктов, дистиллятов до 40% и т.д. Стерилизация: раствором при давлении 2,5 бар и температурой +130 °С в течении 30 минут или дезинфицирующим раствором при температуре +60 °С	25	34	10	0,95	0,60	40/60	Рабочая температура: от -20 °С до +80 °С Безопасность: 3:1 Армирование: текстильная оплетка, спираль из стальной проволоки Внутренняя камера: резин NBR – белая, устойчивая к воздействию жиров и масел, пищевая Внешнее покрытие: резин NR – синяя, пищевая, устойчивая к озону и износу
	32	42	10	0,95	0,68	40/60	
	38	48	10	0,95	0,84	40/60	
	40	50	10	0,95	1,03	40/60	
	51	62	10	0,90	1,40	40/60	
	60	72	10	0,90	1,96	40/60	
	63	76	10	0,90	2,04	40/60	
	76	89	10	0,90	2,34	40/60	
	80	94	10	0,85	2,46	40/60	
	102	117	10	0,85	3,66	40/60	

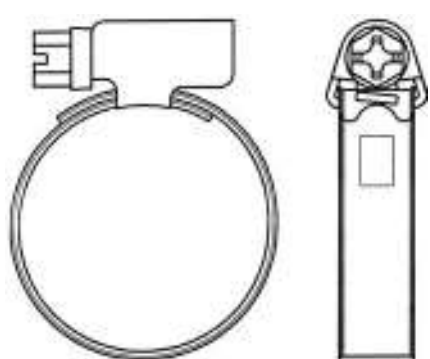
ХОМУТ ШЛАНГА	76100	РАЗМЕРЫ	
		DN	A
		8-2	
		10-16	
		12-20	
		16-25	
		20-32	
		25-40	
		30-45	
		32-50	
		40-60	
		50-70	
		60-80	
		70-90	
		10-100	
		90-110	

ХОМУТ ШЛАНГА КРЕПОСТНЫЙ	76120	РАЗМЕРЫ	
		DN	A
		20-22	18
		23-25	18
		26-28	18
		29-31	20
		32-35	20
		36-39	20
		40-43	20
		44-47	22
		48-51	22
		52-55	22
		56-59	22
		60-63	22
		64-67	22
		68-73	24
		74-79	24
		80-85	24
		86-91	24
		92-97	24
		98-103	24
		104-112	24
	113-121	24	
	122-130	24	
	131-139	26	
	140-148	26	
	149-161	26	

ТЕХНИЧЕСКАЯ ИНФОРМАЦИЯ ПО УПЛОТНИТЕЛЬНЫМ КОЛЬЦАМ

Наименование	Силикон (VMQ силиконовые резин)	EPDM (этилен – пропилен – диеновые резин)	Витон (FPM фторные резин)	Пербунд (NBR нитриловые резин)	PTFE (политетрафторэтилен)
Температурный диапазон применения	в воде стабильно до 100°C возможность стерилизации одновременно до 120-130°C	постоянное эксплуатационное применение от 40°C до +140°C возможность стерилизации одновременно до 130°C	постоянное эксплуатационное применение от 20°C до +200°C возможность стерилизации одновременно до 130-140°C	постоянное эксплуатационное применение от 25°C до +110°C возможность стерилизации одновременно до 130°C	до +200°C физиологически безопасен, использование от 200°C до +260°C
Рекомендуемое применение	высокая температура и нагрузка хорошо устойчив к холоду, хорошо подходит для продуктов обладает хорошей устойчивостью к спиртам	обладает хорошей устойчивостью к воздействию: • органические неорганические и органические кислоты, среды, окисляющие среды, щелочи и кетоны • горячую воду и пар до 130°C	обладает хорошей устойчивостью к воздействию: • минеральные масла • растительные и животные масла • смазки (и определенные присадки) • горюче-смазочные материалы	обладает хорошей устойчивостью к воздействию: • лифтические углеводороды (пропан, бутан, бензин, минеральные масла) • смазочные минеральные масла	обладает хорошей устойчивостью к воздействию практически во всех случаях поверхность гладкая и отшлифованная, нелипкая не происходит имеет химическую устойчивость лучше, чем все иные эластомеры негорючий материал
Ограничения использования (пограничные)	Характеризуется сильным воздействием для: • низкомолекулярные сложные эфиры и эфиры • лифтические и ароматические углеводороды • концентрированные кислоты и щелочи	Не используется для: • растительные и животные масла • лифтические, ароматические и хлорированные углеводороды • минеральные масла	Характеризуется сильным воздействием для: • полярные растворители, например: цетон, метилкетон, этилцетат, диэтилэфир и диоксан • низкомолекулярные органические кислоты (муравьиная кислота и уксусная кислота) • газообразный аммиак, минеральные масла • перегретый водяной пар	Не устойчив к: • полярные растворители • хлорные углеводороды • кетоны • ароматические углеводороды (бензол) • сложные эфиры	Не устойчив к: • жидкие щелочные металлы и некоторые соединения фтора при высоком давлении и температуре материал не имеет упругость резины
Сертификация материала	BGA/FDA	BGA/FDA	BGA/FDA	BGA/FDA	BGA/FDA

BGA = сертификация «Федерального министерства здравоохранения Германии» («Bundesgesundheitsamt»)

FDA = сертификация «Министерства США по продуктам и лекарствам» («US Food and Drug Administration»)

ТАБЛИЦА СООТНОШЕНИЯ РАЗМЕРОВ

дюйм	мм	DN	DIN Ø трубы и ружный	SMS Ø трубы и ружный	ISO Ø трубы и ружный
3/8	9,25	10	12	9,54	17,1
1/2	12,7	15	18	12,7	21,3
1/4	19,0	20	23	19,05	26,9
1	25,4	25	28	25	33,7
1 1/4	31,7	32	35	31,75	42,4
1 1/2	38,1	40	40	38	48,3
2	51,0	50	52 (53)	50,8	60,3
2 1/2	63,5	65	70	63,5	76,1
3	76,1	80	84	76,1	88,9
4	104,0	100	104	101,6	114,3
5	127	125	128	129	139,7
6	152,4	150	154	159	168,3

СООТНОШЕНИЕ ЕДИНИЦ ИЗМЕРЕНИЯ ДАВЛЕНИЯ

1 б р	100000 п ск лей
	100 килоп ск лей
	1000 миллиб р
	1000000 микроб р
	~0,98 тмосфер
	~401,46 дюймов водяного столб
	10 метров водяного столб
	~29,53 дюймов ртутного столб
	~750 миллиметров ртутного столб
	~14,5 фунтов н кв др тный дюйм
	~1,02 килогр ммов н кв др тный дюйм

АДРЕСА ФИЛИАЛОВ

ООО «Инокстрейд» в г. Санкт-Петербурге

Email: spb.spb@inoxtrade.ru
Тел.: +7 (812) 680-29-09/10/11
Адрес: 197101, г. Санкт-Петербург, Каменно-островский проспект, дом 10, лит. М, пом. 21Н

ООО «Инокстрейд» в г. Новосибирске

Email: nsk.nsk@inoxtrade.ru
Тел.: +7 (383) 362-23-23
Адрес: 630110, г. Новосибирск, ул. Богдана Хмельницкого, 90/3

ООО «Инокстрейд» в г. Краснодаре

Email: krasnodar.kr@inoxtrade.ru
Тел.: +7 (861) 997-48-58/82-36
Адрес: 350912, г. Краснодар, п. Пашковский, ул. Мира, дом 1/6

ООО «Инокстрейд» в г. Воронеже

Email: voronej.vr@inoxtrade.ru
Тел.: +7 (473) 239-47-42
Тел.: +7 (473) 239-46-54
Тел.: +7 (473) 250-29-47/48
Адрес: 394033, г. Воронеж, Ленинский проспект, дом 172, пом. 601

ООО «Инокстрейд» в г. Самаре

Email: samara.sm@inoxtrade.ru
Тел.: +7 (846) 20-10-163
Тел.: +7 (841) 299-04-12
Адрес: 443052, г. Самара, ул. Береговая, дом 3

ООО «Инокстрейд» в г. Ставрополе

Email: stav.st@inoxtrade.ru
Тел.: +7 (8652) 38-60-66
Тел.: +7 (8652) 38-44-59/70
Тел.: +7 (8652) 39-42-97
Адрес: 355035, г. Ставрополь, ул. 4-я Промышленная, дом 7

ООО «Инокстрейд» в г. Котельники, МО

Адрес: 140054, Московская область, г. Котельники, Дзержинское шоссе, дом 4
Email: info@inoxtrade.ru
Тел.: +7 (495) 741-75-81/82
Тел.: +7 (495) 741-75-84
Тел.: +7 (495) 559-20-01

ООО «Инокстрейд» в Башкортостане

Email: ufa.ufa@inoxtrade.ru
Тел.: +7 (347) 293-57-50
Адрес: 450520, РБ, Уфимский район, с. Zubovo, ул. Электrozаводская, д.2

ООО «Инокстрейд» в г. Екатеринбурге

Email: ekat.ek@inoxtrade.ru
Тел.: +7 (343) 389-13-17/18/19
Адрес: 620085, г. Екатеринбург, ул. 8 Марта, д. 207а

ООО «Инокстрейд» в г. Ростове-на-Дону

Email: rostov.rs@inoxtrade.ru
Тел.: +7 (863) 224-40-26/27/29
Адрес: 344090, г. Ростов-на-Дону, Машиностроительный пер., дом 5

ООО «Инокстрейд» в г. Нижнем Новгороде

Email: nn.nn@inoxtrade.ru
Тел.: +7 (831) 222-07-28
Тел.: +7 (831) 225-91-32
Тел.: +7 (831) 222-73-29
Адрес: 603127, г. Нижний Новгород, ул. Коновалова, дом 4

ООО «Инокстрейд» в Татарстане

Email: kazan.kz@inoxtrade.ru
Тел.: +7 (843) 249-42-74
Тел.: +7 (843) 200-97-12
Адрес: 422701, РТ, с. Высокая Гора, ул. Полковная, дом 4, офис 9